

ATV/UTV EQUIPMENT GUIDE | 2014

MOOSE UTILITY DIVISION | 2014

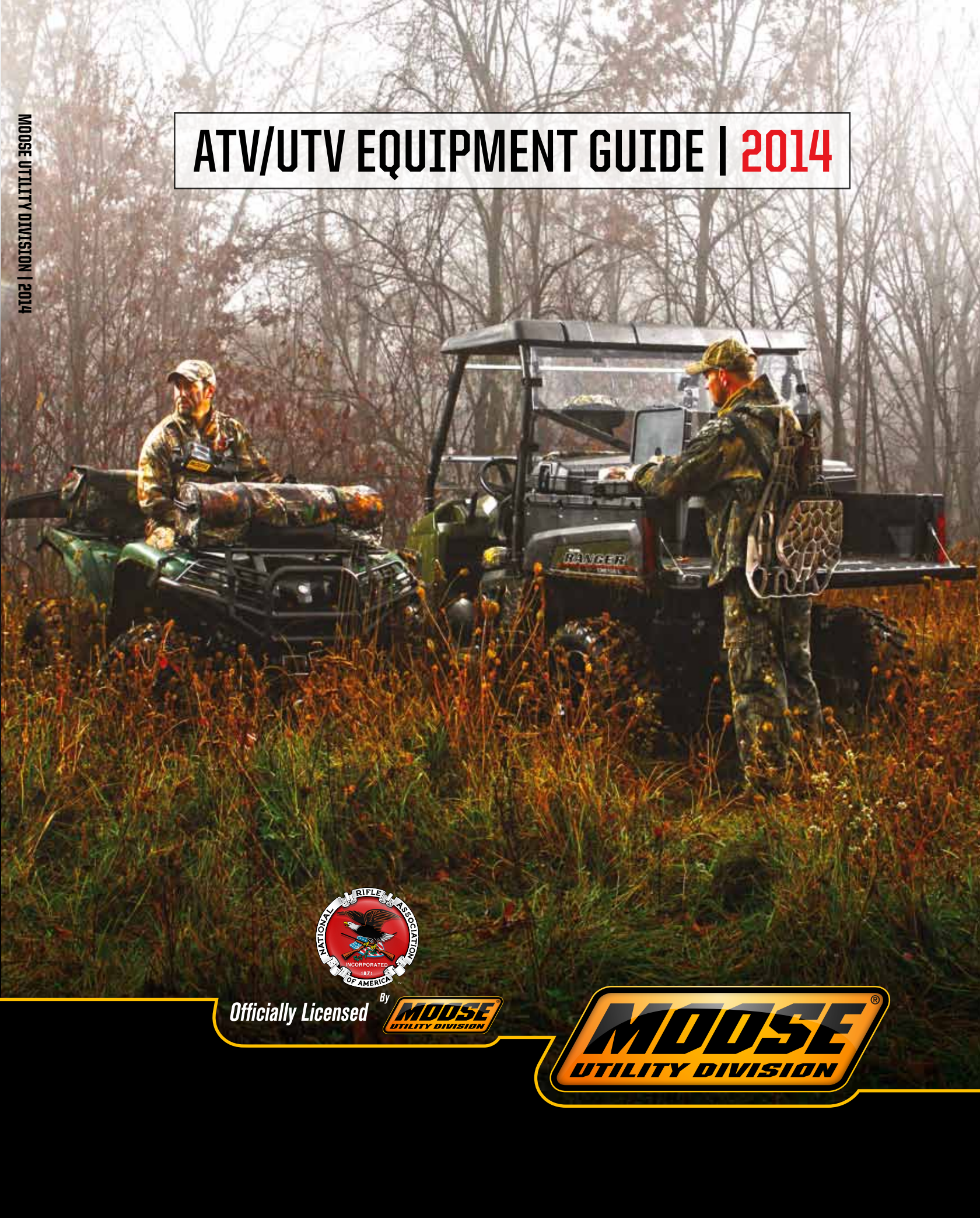

Officially Licensed By **MOOSE UTILITY DIVISION**







Moose Utility Division
PROVIDING 500 PRODUCTS
 Since 1996



DEMAND THE BRAND

It was born out of mud holes, snow drifts and ridge tops. Seventeen years ago Moose Utility Division set out on a mission to provide our customers with the most diverse line-up of ATV and UTV accessories on the planet. You see friends, your unit wasn't built to accomplish one thing, but rather a multitude of tasks. We get this and that is why we created this versatile, outdoor beast. It's in our blood and we think you'll agree we have succeeded, but it is a work in progress. The following pages are just an example of our commitment to making sure you have accomplished all you want to at the end of the day. We also realize it may leave you hungry for more and that is why we are constantly updating and adding new products. We're doing it right now and will continue to do it because you deserve the best and settle for nothing less. Demand the brand!

- PLOWS
- WINCHES
- UTV
- RACKS
- LUGGAGE
- BODY
- CONTROLS
- ELECTRICAL
- WHEELS & TIRES
- SUSPENSION & DRIVE
- ENGINE
- NRA BY MOOSE
- RIDER
- TOWING
- GARAGE
- PROMO

EQUIPMENT GUIDE



PLOWS 6-20

ACCESSORIES
APPLICATION CHART
HYDRAULIC TURN KIT
MOUNT/LIFT SYSTEMS
REPLACEMENT PARTS
RM4 MOUNTING SYSTEM
STANDARD & COUNTY BLADES
TIRE CHAINS
V-PLOW W/ HYDRAULICS

WINCHES 21-23

ACCESSORIES
WINCHES

UTV 24-49

ARCTIC CAT PROWLER
CAN-AM COMMANDER
HONDA BIG RED
KAWASAKI MULE
KAWASAKI TERYX
POLARIS RANGER
POLARIS RZR
UNIVERSAL ACCESSORIES
YAMAHA RHINO

RACKS 50-63

ACCESSORIES
BACK REST
CARRIERS & HOLDERS
DROP RACK
GUN/BOW CARRIERS
ICE AUGER CARRIER
MESH FRONT AND REAR RACKS
QUICK RELEASE SYSTEM
RACK EXTENSIONS
SPREADER
SPRAYERS

LUGGAGE 64-79

ACCESSORIES
ALUMINUM CASES
COOLER BAGS
FENDER BAGS
FRONT STORAGE TRUNKS
REAR RACK BAGS
REAR STORAGE TRUNKS
TANK BAGS

BODY 80-89

BUMPERS
CAB ENCLOSURES
COVERS
FENDER COVER KITS
FENDER EXTENSIONS
LICENSE PLATE HOLDER
SEAT COVERS
WINDSHIELDS
A-ARM GUARDS
CV BOOT GUARDS
SKIDPLATES

CONTROLS 90-93

GAUNTLETS
GRIPS
HANDGUARDS
HANDLEBARS
HAND AND GRIP WARMERS
HOLDERS GPS/PHONE, CUP
MIRRORS
SEAT HEATER
SHIFT LEVERS
THUMB ASSISTS

ELECTRICAL 94-103

BATTERIES
HOUR METERS
IGNITION STATORS
POWER PORTS
REGULATOR/RECTIFIERS
SOLENOID
SPOTLIGHTS
STARTERS

WHEELS & TIRES 104-117

387X WHEEL
393X WHEEL
427X WHEEL
901X TIRE
TIRE/WHEEL KITS
TUBES





SUSPENSION & DRIVE.....118-171

- ACCESSORIES/TOOLS
- AXLES & HALFSHAFTS
- BALL JOINT & KING PIN KITS
- BEARINGS
- BRAKES
- CALIPER REBUILD KITS/PINS
- CV KITS & ACCESSORIES
- DRIVE BELTS
- FRONT AXLE ASSEMBLIES
- LIFT KITS
- ROTORs
- SHOCK COVERS
- STARTER DRIVES
- SWINGARM BOLT KITS
- TIE RODS
- U-JOINTS
- WHEEL BEARINGS
- WHEEL SPACERS

ENGINE..... 172-185

- AIR FILTERS
- BEARINGS
- CARB REPAIR KITS
- CLUTCH KITS
- CYLINDERS
- CONNECTING RODS
- COOLING FANS
- DRAIN PLUGS
- EXHAUST TIPS
- GASKETS
- OIL FILTERS/FILTER OIL
- PISTONS
- POWER & JET KITS

NRA BY MOOSE 186-203

- BACK REST
- COVERS
- DRINK/DEVICE HOLDERS
- FENDER BAGS
- GUN RACKS/CASES
- HANDWARMERS
- HEATED GRIPS
- RACK BAGS
- RAMPS
- TANK BAGS
- TIE DOWNS
- STORAGE TRUNK
- TREE STAND CARRIER
- WINCH
- WINDSHIELD

RIDER 204-215

- BOOTS
- BOOT, HELMET & GLOVE DRYER
- CASUALS
- EXPEDITION™ GEAR
- GLOVES
- MONARCH PASS™ GEAR
- QUALIFIER™ GEAR
- RAIN SUIT

TOWING216-219

- CARGO TUB
- HITCHES
- TRAILERS

GARAGE 220-225

- CHEMICALS
- RAMPS
- TIE-DOWNS/TOW STRAP
- TIRE REPAIR KITS
- TOOLS

PROMO.....226

- BANNERS
- KEY CHAIN
- SIGNS
- STICKERS

2014

M.U.D.





PROMO	GARAGE	TOWING	RIDER	NRA BY MOOSE	ENGINE	SUSPENSION & DRIVE	WHEELS & TIRES	ELECTRICAL	CONTROLS	BODY	LUGGAGE	RACKS	UTV	WINCHES	PLOWS
-------	--------	--------	-------	-----------------	--------	-----------------------	-------------------	------------	----------	------	---------	-------	-----	---------	--------------



72" V-PLOW W/ HYDRAULICS

Independent right and left blade control. 17" blade height. Total forward to back swing of 60 degrees per side. Heavy-duty, dual action cylinders with beefy 3/4" chrome plated shafts. Hydraulic overload protection to prevent cylinder damage. State of the art electronic control package. Hand control features large buttons for easy one hand operation while wearing gloves. Winch required for raising and lowering the blade. Made in the USA.

WHAT TO ORDER:

1. Push tube with hydraulics (4501-0191.)
2. Bottom mount specific to your UTV (See chart.)
3. 72" V-blade (4501-0197 & 4501-0198.)
4. Winch & winch mount, if UTV doesn't already have a winch mounted (See chart.) See pages 20-21 for winches.

- PUSH TUBE W/ HYDRAULICS** > \$1965.95
BOTTOM MOUNT > \$128.95 EACH
72" V-BLADE LEFT > \$266.95
72" V-BLADE RIGHT > \$266.95
WINCH MOUNT > \$78.95 EACH



◀ **INDEPENDENT LEFT AND RIGHT BLADE CONTROL** ▶



FITS MODEL	1-REQUIRED PUSH TUBE W/HYDRAULICS	2-REQUIRED BOTTOM MOUNT	3-REQUIRED 72" V-BLADE LEFT	3-REQUIRED 72" V-BLADE RIGHT	4-OPTIONAL WINCH MOUNT
ARCTIC CAT					
550 PROWLER 4X4 10-12	4501-0191	4501-0192	4501-0197	4501-0198	4505-0465
650 PROWLER 4X4 06-09	4501-0191	4501-0192	4501-0197	4501-0198	4505-0405 ²
700 PROWLER 4X4 08-09	4501-0191	4501-0192	4501-0197	4501-0198	4505-0405 ²
700 PROWLER 4X4 10-13	4501-0191	4501-0192	4501-0197	4501-0198	4505-0465
1000 PROWLER 4X4 09	4501-0191	4501-0192	4501-0197	4501-0198	4505-0405 ²
1000 PROWLER 4X4 10-12	4501-0191	4501-0192	4501-0197	4501-0198	4505-0465
CAN-AM					
COMMANDER 800/1000 11-13	4501-0191	4501-0316	4501-0197	4501-0198	4505-0437
HONDA					
BIG RED 09-13	4501-0191	4501-0224	4501-0197	4501-0198	4505-0406
JOHN DEERE					
GATOR XUV 550 12-13	4501-0191	4501-0428	4501-0197	4501-0198	4505-0506
GATOR XUV 825I 11-13	4501-0191	4501-0423	4501-0197	4501-0198	4505-0466
GATOR RSX 850I 12-13	4501-0191	4501-0431	4501-0197	4501-0198	4505-0506
GATOR XUV 855D 13	4501-0191	4501-0423	4501-0197	4501-0198	4505-0466
KAWASAKI					
610 MULE 4X4 05-13	4501-0191	4501-0193	4501-0197	4501-0198	4505-0400
750 TERYX 4X4 08-13	4501-0191	4501-0188	4501-0197	4501-0198	4505-0401 ¹
750 TERYX 4(4 SEATER) 4X4 12-13	4501-0191	4501-0188	4501-0197	4501-0198	-
3010 MULES (2 DOOR) 07-08	4501-0191	4501-0194	4501-0197	4501-0198	4505-0399 ^{2,3}
4010 MULES 09-13 (NOT FOR DIESEL)	4501-0191	4501-0194	4501-0197	4501-0198	4505-0398 ²
POLARIS					
RANGER 400 10-13	4501-0191	4501-0192	4501-0197	4501-0198	4505-0436
RANGER 500 (ALL) 05-08	4501-0191	4501-0192	4501-0197	4501-0198	4505-0403
RANGER 500 (ALL) 09-10	4501-0191	4501-0195	4501-0197	4501-0198	4505-0407
RANGER 500 (ALL) 11-12	4501-0191	4501-0192	4501-0197	4501-0198	4505-0436
RANGER 700 (ALL) 05-08	4501-0191	4501-0192	4501-0197	4501-0198	4505-0403
RANGER 700 XP 09	4501-0191	4501-0195	4501-0197	4501-0198	4505-0407
RANGER 800 10-13	4501-0191	4501-0195	4501-0197	4501-0198	4505-0407
RANGER 800 13 (MIDSIZE)	4501-0191	4501-0192	4501-0197	4501-0198	4505-0436
RANGER 900 13	4501-0191	4501-0430	4501-0197	4501-0198	4505-0505
RANGER DIESEL 11	4501-0191	4501-0195	4501-0197	4501-0198	4505-0407
RZR 800/RZR 4 & S 08-13	4501-0191	4501-0192	4501-0197	4501-0198	4505-0404
RZR 900 XP/RZR 900 (4 PASSENGER) 11-13	4501-0191	4501-0416	4501-0197	4501-0198	4505-0458 ²
YAMAHA					
RHINO 450 06-11	4501-0191	4501-0188	4501-0197	4501-0198	4505-0402
RHINO 660 04-07	4501-0191	4501-0188	4501-0197	4501-0198	4505-0402
RHINO 700 08-13	4501-0191	4501-0188	4501-0197	4501-0198	4505-0402

¹ WORKS ONLY WITH WARN 2,500, 3,000 AND 4,000LB WINCHES ² NOT FOR USE WITH WARN 4,000LB WINCH ³ ONLY FOR 2-BOLT WINCHES



HYDRO-TURN KIT > \$799.95

Allows you to turn your Moose Plow side to side without getting off the machine. Top-of-the-line Parker industrial hydraulic pump is used as the heart of this kit. Dual heavy-duty hydraulic cylinders, with 3/4" chrome-plated shafts, turn the blade and hold it in position. Relief valve-protected easy thumb switch operation. No drilling required; the kit bolts to any M93-11001 push tube, except the RM3/RM4. Requires a winch for raising and lowering and a plow blade. Kit includes hydraulics package, mounting brackets, wiring harness, thumb switch, and complete instructions. Not for use on UTV's. Made in the USA.

DESCRIPTION	PART #
HYDRO-TURN KIT	4501-0279

- BOTTOM MOUNT** > \$79.95
- EXTENDED PUSH TUBE** > \$231.95
- WINCH MOUNT** > \$62.95
- PLOW BLADES** > \$191.95-\$333.95

WHAT TO ORDER:

1. Bottom mount specific to your ATV (See pages 16-19.)
2. Universal push tube (Part # M93-11001.)
3. Winch & winch mount, if ATV doesn't already have a winch mounted (See pages 16-19.)
4. Hydro-turn kit (4501-0279.)
5. Plow blade of your choice (see page 13)

42" STANDARD BLADE	4501-0067
50" STANDARD BLADE	M91-10050
50" BLACK STANDARD BLADE	4501-0042
55" STANDARD BLADE	4501-0068
60" STANDARD BLADE	M91-10060
72" STANDARD BLADE	M91-10072
50" COUNTY BLADE	M91-10051
60" COUNTY BLADE	M91-10061



PLOWS

WINCHES

UTV

RACKS

LUGGAGE

BODY

CONTROLS

ELECTRICAL

WHEELS & TIRES

SUSPENSION & DRIVE

ENGINE

NRA BY MOOSE

RIDER

TOWING

GARAGE

PROMO



30+\"/>



RM4 RAPID MOUNT PLOW SYSTEM FOR ATVS

Industry leading triangulated front mount push tube distributes the plowing force over a wider area for maximum strength and stability. Simple hand lever integrated into the push tube engages and disengages the plow from the machine in seconds. Built in retractable kickstand keeps your plow at the correct height to simply drive close and connect the plow. Class leading lift height of over 30\"/>

WHAT TO ORDER:

1. Plow frame (4501-0329.)
2. Mount plate specific to your ATV.
3. Winch & winch mount, if ATV doesn't already have a winch mounted (See chart.) See pages 20-21 for winches.
4. Plow blade of your choice (see page 13:)

42\"/>	4501-0067
50\"/>	M91-10050
50\"/>	4501-0042
55\"/>	4501-0068
60\"/>	M91-10060
72\"/>	M91-10072
50\"/>	M91-10051
60\"/>	M91-10061

- PLOW FRAME** > \$328.95
- MOUNT PLATE** > \$141.95
- WINCH MOUNT** > \$62.95
- PULLEY KIT** > \$39.95
- PLOW BLADES** > \$191.95-\$335.95
- REPL. HITCH PINS** > \$7.95

REPLACEMENT PARTS	PART #
HITCH PINS (2-PK)	4501-0421
PULLEY KIT	4501-0387

FITS MODEL	1-REQUIRED PLOW FRAME	2-REQUIRED MOUNT PLATE	3-REQUIRED WINCH MOUNT	4-REC. OR REQ. PULLEY KIT
ARCTIC CAT				
400 06-11	4501-0329	4501-0339	4505-0356	4501-0387 ³
450 10-12	4501-0329	4501-0339	4505-0356	4501-0387 ³
500 06-13	4501-0329	4501-0339	4505-0356	4501-0387 ³
550 09-13	4501-0329	4501-0339	4505-0356	4501-0387 ³
650 05-11	4501-0329	4501-0339	4505-0356	4501-0387 ³
700 07-13	4501-0329	4501-0339	4505-0356	4501-0387 ³
1000 09-11	4501-0329	4501-0339	4505-0356	4501-0387 ³
CAN-AM				
OUTLANDER 400 06-13	4501-0329	4501-0332 ¹	4505-0361	4501-0387 ⁴
OUTLANDER 500 07-12	4501-0329	4501-0332	4505-0359	4501-0387 ⁴
OUTLANDER 500 13	4501-0329	4501-0429	-	4501-0387 ⁴
OUTLANDER 650 06-12	4501-0329	4501-0332	4505-0359	4501-0387 ⁴
OUTLANDER 650 MAX XT 13	4501-0329	4501-0332	-	4501-0387 ⁴
OUTLANDER 800 06-11	4501-0329	4501-0332	4505-0359	4501-0387 ⁴
OUTLANDER 800R 12-13	4501-0329	4501-0429	4505-0359	4501-0387 ⁴
OUTLANDER 1000R 12-13	4501-0329	4501-0429	4505-0359	4501-0387 ⁴



FITS MODEL	1-REQUIRED PLOW FRAME	2-REQUIRED MOUNT PLATE	3-REQUIRED WINCH MOUNT	4-REC. OR REQ. PULLEY KIT
HONDA				
RANCHER 420 07-13	4501-0329	4501-0330	4505-0360 ²	4501-0387 ³
FOREMAN/RUBICON 500 (ALL) 08-11	4501-0329	4501-0337	4505-0355	4501-0387 ³
FOREMAN RUBICON 500 12-13	4501-0329	4501-0337	4505-0355	4501-0387 ³
FOREMAN 500 12-13	4501-0329	4501-0426	4505-0455	4501-0387 ³
RINCON 650/680 03-13	4501-0329	4501-0338	4505-0363	4501-0387 ³
KAWASAKI				
BRUTE FORCE 650 (IND. SUSP.) 11-12	4501-0329	4501-0333	4505-0376	4501-0387 ⁴
BRUTE FORCE 750 08-13	4501-0329	4501-0333	4505-0376	4501-0387 ⁴
POLARIS				
SPORTSMAN 400 11-13	4501-0329	4501-0334	4505-0396	4501-0387 ⁴
SPORTSMAN 500 11-13	4501-0329	4501-0334	4505-0396	4501-0387 ⁴
SPORTSMAN 550 XP (ALL) 09-13	4501-0329	4501-0335	4505-0396	4501-0387 ³
SPORTSMAN 800 11-13	4501-0329	4501-0334	4505-0396	4501-0387 ⁴
SPORTSMAN 850 XP (ALL) 09-13	4501-0329	4501-0335	4505-0396	4501-0387 ³
SUZUKI				
KING QUAD 450 07-10	4501-0329	4501-0336	4505-0378 ⁵	4501-0387 ³
KING QUAD 500 09-13	4501-0329	4501-0336	4505-0378 ⁵	4501-0387 ³
KING QUAD 700 05-07	4501-0329	4501-0336	4505-0378 ⁵	4501-0387 ³
KING QUAD 750 08-13	4501-0329	4501-0336	4505-0378 ⁵	4501-0387 ³
YAMAHA				
GRIZZLY 550 09-13	4501-0329	4501-0331	4505-0375	4501-0387 ⁴
GRIZZLY 700 07-13	4501-0329	4501-0331	4505-0375	4501-0387 ⁴

¹ MUST USE CAN-AM WINCH MOUNT ON OUTLANDER 400 ² NOT FOR USE WITH MOOSE 3700LB WINCH OR TERRA SERIES 2500/4500 ³ PULLEY KIT RECOMMENDED ⁴ PULLEY KIT REQUIRED ⁵ MUST USE ROLLER FAIRLEAD M91-50070



ARCTIC CAT



HONDA RINCON

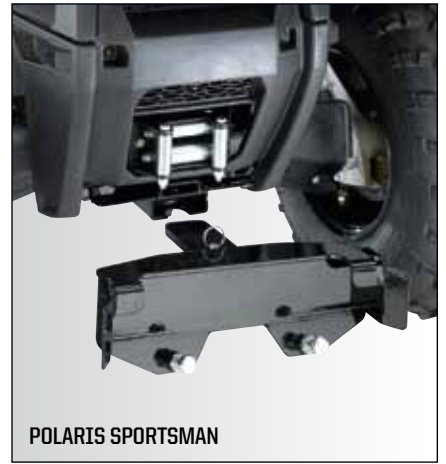

POLARIS SPORTSMAN



CAN-AM OUTLANDER 11



KAWASAKI BRUTE FORCE

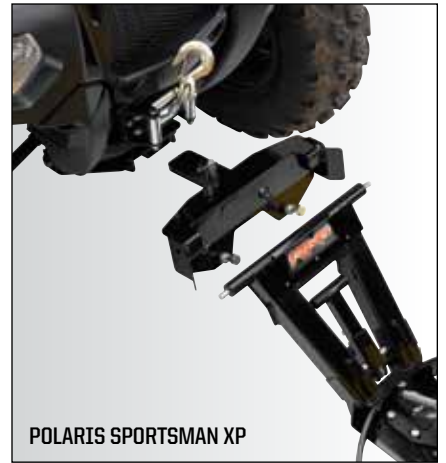

POLARIS SPORTSMAN XP



CAN-AM OUTLANDER 12



HONDA FOREMAN 11



SUZUKI KING QUAD



HONDA RANCHER



HONDA FOREMAN 12

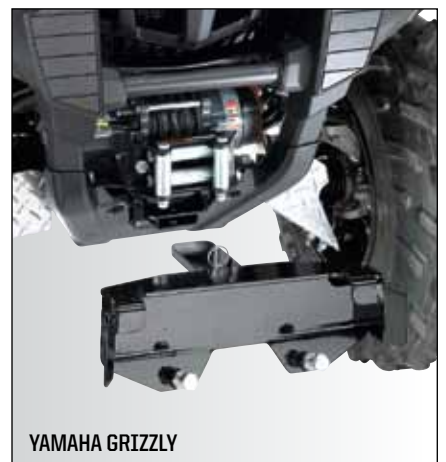

YAMAHA GRIZZLY

PLOWS
WINCHES
UTV
RACKS
LUGGAGE
BODY
CONTROLS
ELECTRICAL
WHEELS & TIRES
SUSPENSION & DRIVE
ENGINE
NRA BY MOOSE
RIDER
TOWING
GARAGE
PROMO

M.U.D.



30+¹ LIFT HEIGHT



RM4 RAPID MOUNT PLOW SYSTEM FOR UTV'S

Industry leading triangulated front mount push tube distributes the plowing force over a wider area for maximum strength and stability. Simple hand lever integrated into the push tube engages and disengages the plow from the machine in seconds. Built in retractable kickstand keeps your plow at the correct height to simply drive close and connect the plow. Class leading lift height of over 30¹ on some models! Tough, machine-side mount bolts on easily without modifications. Unique two-piece mount kit allows you to quickly remove the large machine-side mount with two pins when not in use. Blade can be turned to any of 5 positions easily using the blade position adjuster located on the push tube. Made in the USA.

FITS MODEL	1-REQUIRED PLOW FRAME	2-REQUIRED MOUNT PLATE	3-REQUIRED WINCH MOUNT
HONDA			
BIG RED 09-13	4501-0306	4501-0311	4505-0406 ²
KAWASAKI			
MULE 610 05-13	4501-0306	4501-0435	4505-0400
4010 MULES 09-13 (NOT FOR DIESEL)	4501-0306	4501-0310 ²	-
TERYX 750 4X4 08-12	4501-0306	4501-0312	4505-0401
TERYX 750 4 (4-SEATER) 4X4 12-13	4501-0306	4501-0312	-
POLARIS			
RANGER 400 10-13	4501-0306	4501-0308	4505-0436
RANGER 500 09-10	4501-0306	4501-0308	4505-0407
RANGER 500 11-12 (INCLUDING CREW MODEL)	4501-0306	4501-0308	4505-0436
RANGER 700/800 09-13 (WILL NOT FIT 09 CREW MODEL)	4501-0306	4501-0308	4505-0407
RANGER 800 MIDZISE 13	4501-0306	4501-0308	4505-0407
RANGER DIESEL 11	4501-0306	4501-0308	4505-0407
RANGER EV (ELECTRIC) 12	4501-0306	4501-0308	4505-0436
YAMAHA			
RHINO 450/660/700 06-13	4501-0306	4501-0307	4505-0402

¹ CANNOT USE HONDA BRAND WINCH MOUNT WITH RM4 SYSTEM. ² MUST USE KAWASAKI BRAND WINCH MOUNT WITH RM4 SYSTEM.



YAMAHA RHINO

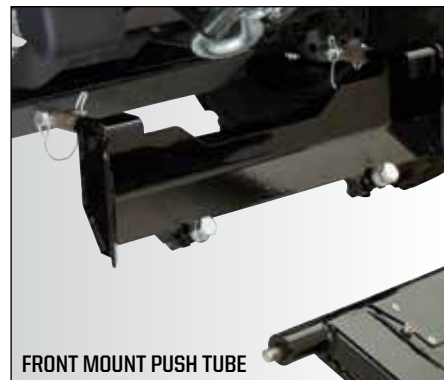

FRONT MOUNT PUSH TUBE



INTEGRATED KICK-STAND



EASY TO CONNECT AND DISCONNECT

WHAT TO ORDER:

1. Plow frame (4501-0306.)
2. Mount plate specific to your UTV.
3. Winch & winch mount, if UTV doesn't already have a winch mounted (See chart.) See pages 20-21 for winches.
4. A plow blade of your choice.

PLOW FRAME > \$328.95 **MOUNT PLATE** > \$141.95
WINCH MOUNT > \$78.95 **72" PLOW BLADE** > \$332.95



MOOSE PLOW > \$191.95 - \$335.95

Formed from 11-gauge steel, plow blade has a curved design that provides better snow/dirt roll-off at any angle. Our standard 50" blade clears a 44 1/2" path when angled and our 60" blade clears 53 1/2" path when angled. The 72" blade is designed for utility vehicles, ATV's 500cc and larger and clears a 64" path when angled. Rubber plow flap sold separately (See page 14.) 72" blade comes standard with plow flap. Side shield sold separately (See page 15.) Made in the USA.

MOOSE PLOW	BLADE HEIGHT	PART #
42" YELLOW BLADE	15"	4501-0067
50" YELLOW BLADE	15"	M91-10050
50" BLACK BLADE	15"	4501-0042
55" YELLOW BLADE	15"	4501-0068
60" YELLOW BLADE	15"	M91-10060
72" YELLOW BLADE	17"	M91-10072

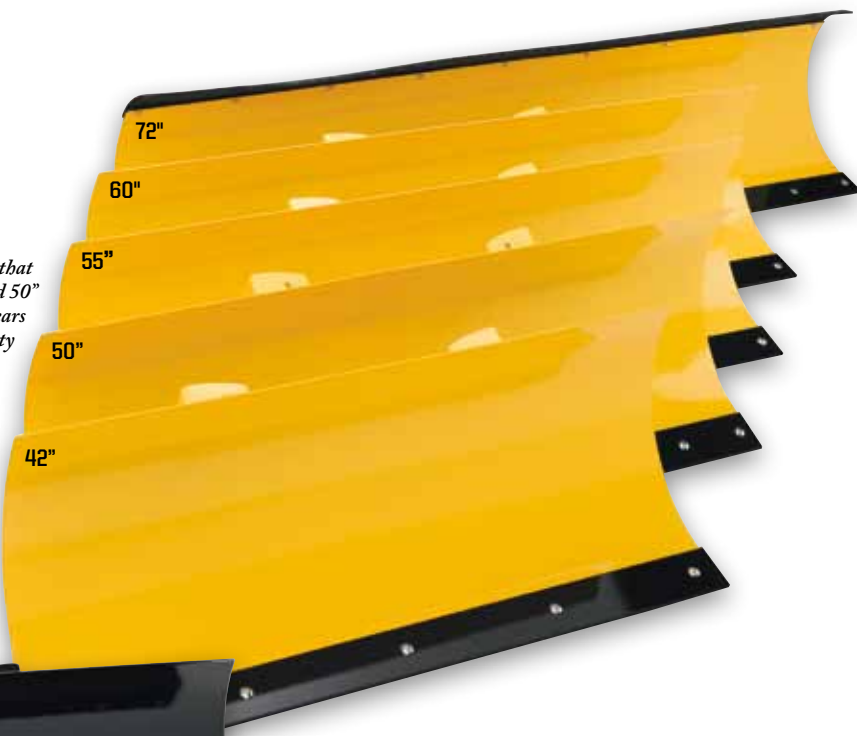

WHAT TO ORDER:

1. A Moose Plow blade 42", 50", 55", 60" or 72".
2. A bottom mount specific to your ATV (See pages 16-18.)
3. A universal push tube (Part # M93-11001.)
4. A blade lift system. Either a winch and winch mount, universal hand lift or an electric plow lift (See pages 14-15, 16-18.)



COUNTY PLOW > \$262.95 - \$335.95

Features a "wing" design and blade curve that guides snow up and away from the surface you're clearing. The height of the wing measures 26" tall with the plow tapering down to 16" at the end. Standard rubber plow flap helps keep snow from blowing up and over into your face. Side shield sold separately (See page 15.) Made in the USA.

COUNTY PLOW	BLADE HEIGHT	PART #
50" YELLOW BLADE	16"-26"	M91-10051
60" YELLOW BLADE	16"-26"	M91-10061

WHAT TO ORDER:

1. A County Plow blade 50" or 60".
2. A bottom mount specific to your ATV (See pages 14-16.)
3. A universal push tube (Part # M93-11001.)
4. A blade lift system. Either a winch and winch mount, universal hand lift or an electric plow lift (See pages 14-16, 18-19.)

PLOWS

WINCHES

UTV

RACKS

LUGGAGE

BODY

CONTROLS

ELECTRICAL

WHEELS & TIRES

SUSPENSION & DRIVE

ENGINE

NRA BY MOOSE

RIDER

TOWING

GARAGE

PROMO

MOOSE



ATV/UTV PUSH TUBE > \$231.95-\$284.95

Increases ground clearance. Blade swivel constructed of 3/8" steel. Five blade swivel positions and four-way blade pitch adjustment. Made in the USA.

DESCRIPTION	PART #
ATV/UTV PUSH TUBE (46")	M93-11001
PUSH TUBE FOR ATVS WITH TRACK SYSTEM (58")	4501-0107



ATV/UTV BOTTOM MOUNT > \$79.95-\$128.95

Quick-connect mounting hardware for easy hook-up and fast removal. Includes all necessary hardware to attach universal push tube and plow. Provides more ground clearance when plow blade is removed. Made in the USA.

DESCRIPTION	PART #
BOTTOM MOUNT	APPLICATION CHART ON PG 16-18



ATV/UTV WINCH MOUNT KIT > \$62.95-\$78.95

Winch mount kits accept Warn®, Superwinch® and all Moose winches. Made in the USA.

DESCRIPTION	PART #
WINCH MOUNT KIT	APPLICATION CHART ON PG 16-18



UNIVERSAL HAND LIFT > \$159.95

Length of the overall swing on the lift handle reduced for easier lift/lower. Simple bolt on installation to all M93-11001 push tubes. Capable of lifting up to 12" off the ground. Universal fit for all ATV's. Made in the USA.

DESCRIPTION	PART #
UNIVERSAL HAND LIFT	4501-0427

PUSH TUBE CONVERSION KIT > \$39.95

Converts old-style push tubes for use with extended lift system bottom mount kits. Made in the USA.

DESCRIPTION	PART #
PUSH TUBE CONVERSION KIT	4501-0022



ELECTRIC PLOW LIFT > \$10.95-\$278.95

Lifts the plow without the need or use of a winch. Screw-drive system runs at optimum speed; has plenty of lifting power and low amp draw. Compact design fits all Moose plow systems new or old except the RM4, V-plow system and hydraulic turn kits. Includes wiring, hardware and all-weather handlebar mounted switch. Made in the USA.

DESCRIPTION	PART #
ELECTRIC PLOW LIFT	4501-0309
REPLACEMENT PARTS	
RELAY WIRING SYSTEM	4501-0009
SWITCH WIRING SYSTEM	4501-0112
RELAY	M91-80094
STRAP	4501-0011

PLOW LIGHT MOUNT KIT > \$2.95-\$38.95

Base made from steel. Light support arms made from 7-gauge steel. Great for night time, or early morning plowing. Attaches to front rack of ATV. Uses 1 1/8" u-bolts. Details for MDL01 Halogen light kit are on page 94. Made in the USA.

DESCRIPTION	PART #
PLOW LIGHT MOUNT KIT	2001-0116
HALOGEN LIGHT KIT	MDL01
REPLACEMENT BULB	MDL01R
REPLACEMENT LENS	MDL01L

PLOW MARKERS > \$22.95

Clearly marks plow edges for increased visibility and safety. Durable hard rubber; sold in pairs. Made in the USA.

DESCRIPTION	PART #
16" PLOW MARKERS	M91-50040



STEEL REPLACEMENT WEAR BARS > \$28.95-\$44.95

Available in 3" heavy-duty design. Comes standard on Moose plows and County plows. Reversible for longer life. Replacement nuts/bolts sold separately on next page. Made in the USA.

DESCRIPTION	PART #
42" MOOSE BLADE WEAR BAR	4501-0074
50" MOOSE BLADE WEAR BAR	M91-50053
55" MOOSE BLADE WEAR BAR	4501-0075
60" MOOSE BLADE WEAR BAR	M91-50063
60" CYCLE COUNTRY WEAR BAR	M91-50065
72" MOOSE BLADE WEAR BAR (2-PIECE 36")	4501-0045
MOOSE V-PLOW BLADE WEAR BAR (2-PIECE 36")	4501-0290

PLASTIC REPLACEMENT WEAR BARS > \$5.95-\$29.95

5/8" thick and provide softer impact than steel. Great for paver/stone driveways. Ultra High Molecular Weight plastic (UHMW) construction. Reversible - just flip when worn. Requires longer bolts; available in bolt kit. Made in the USA.

DESCRIPTION	PART #
FITS ALL 50" MOOSE BLADES	4501-0318
FITS ALL 55" MOOSE BLADES	4501-0319
FITS ALL 60" MOOSE BLADES	4501-0320
UNIVERSAL 60" / NO HOLES / DRILL HOLES CUT DOWN FOR SMALLER BLADES	4501-0321
BOLT KIT / 7 BOLTS AND NUTS	4501-0317



SHOCK SPRING WEDGES > \$39.95

Installs in minutes and offers additional front or rear suspension stiffness while using items such as snow plows, sprayers, and spreaders. Fits most utility ATV stock shocks with spring diameter up to 3". Sold in pairs. Made in the USA.

DESCRIPTION	PART #
SUSPENSION SPRING WEDGES	0431-0260



RUBBER PLOW FLAP > \$18.95-\$25.95

Increases your control of airborne snow while plowing. Comes standard on County Plow's. Made in the USA.

DESCRIPTION	PART #
50" RUBBER FLAP	4501-0069
55" RUBBER FLAP	4501-0070
60" RUBBER FLAP	4501-0071
72" RUBBER FLAP	4501-0072

PLOW SIDE SHIELD > \$58.95

Reduce the amount of snow or dirt overflow. Put side shields on both ends of a straight blade to contain even more plowed material. Constructed from sturdy, 11-gauge steel and measures 15" tall x 10" deep. Some drilling is required. Fits both the County Plow and the Moose Plow. Sold separately. Made in the USA.



DESCRIPTION	PART #
MOOSE PLOW SIDE SHIELD	M91-50010



REPLACEMENT BLADE SKIDS > \$11.95-\$45.95

Made in the USA.

DESCRIPTION	PART #
EXTRA-DUTY BLADE SKID (OLD SCREW-IN)	M91-50020
PLOW SKID (NEW STYLE)	M91-50021
CONVERSION KIT FOR NEW SKIDS	M91-50022
HARDENED SKID (NEW STYLE)	M91-50023
SCREW-IN STYLE (OLD STYLE)	M91-50080

PLOW REPLACEMENT PARTS > \$3.95-\$45.95

Made in the USA.

DESCRIPTION	QTY	PART #
TOUCH UP PAINT YELLOW	EA	3712-0007
WIRE LOOP PINS	2	4501-0015
WIRE LOOP PINS	2	4501-0016
1/2" X 1" SHOULDER BOLT	4	4501-0088
3/8" X 3/4" SHOULDER BOLT	4	4501-0089
5/16" X 1-1/4" X 2-1/4" U-BOLT	12	4501-0090
5/16" X 1-1/8" X 2-1/4" U-BOLT (SQUARE U-BOLT)	12	4501-0091
SKID LYNCH PIN	4	4501-0092
RUBBER SKID WASHERS	8	4501-0093
BLADE POSITION PIN SPRING	4	4501-0094
1/2" WASHER	20	4501-0095
3/8" NYLOCK NUT	20	4501-0096
5/16" NYLOCK NUT	48	4501-0097
5/16" FLAT WASHER	48	4501-0098
5/16" X 1-1/4" X 2-3/4" U-BOLT	12	4501-0099
5/16" X 1-1/4" X2 U-BOLT	12	4501-0199
5/16" X 1-3/8" X 2-3/16" U-BOLT	12	4501-0200
5/16" X 2-1/4" X 4-1/4" U-BOLT (SQUARE U-BOLT)	12	4501-0201
5/16" X 1" CARRIAGE BOLT AND 5/16" WHIZ NUT	18	4501-0205
5/8" FLAT WASHERS	18	4501-0223
HANDLIFT BUSHINGS	4	4501-0305
HEAVY DUTY SKID - SCREW IN STYLE	EA	M91-50020
REPLACEMENT SKID - NON SCREW IN STYLE	EA	M91-50021
PLOW SKID CONVERSION KIT	KT	M91-50022
HARDENED SKID - NON SCREW IN STYLE	EA	M91-50023
SHOULDER/PIVOT BOLT OLD STYLE	EA	M91-50032
BLADE POSITION ASSEMBLY (NOT FOR RM3)	EA	M91-50034
BLADE SPRINGS	PR	M91-50036
BLADE STOP KIT	2	M91-50038
SKID - SCREW IN STYLE	EA	M91-50080
MANUAL LIFT REPLACEMENT STRAP	EA	4501-0322
AXLE CAPS FOR MANUAL LIFT	4	4501-0323
5/16" X 1-1/4" X 2-1/4" U-BOLT (SQUARE U-BOLT)	12	4501-0324
5/16" X 1-1/2" X 3-1/2" U-BOLT (SQUARE U-BOLT)	12	4501-0325
5/16" X 2" X 3" U-BOLT	12	4501-0326
MANUAL LIFT CLEVIS	2	4501-0327
PLOW SKID BRACKETS	4	4501-0328
PULLEY KIT	EA	4501-0387
RM4 HITCH PINS	2	4501-0421



2040-1035

BEACON WARNING LIGHT > \$12.95-\$24.95

Heavy duty magnetic base. Adhesive hook and look material included for non-magnetic surface mounting. 12' coiled cord. Pole measures 30" tall. 12V DC 8W. 10' extension cord available (part # 2040-1035); sold separately. Made in the USA.

DESCRIPTION	PART #
BEACON LIGHT	2040-1034
EXTENSION CORD	2040-1035
EXTENSION POLE	2040-1273

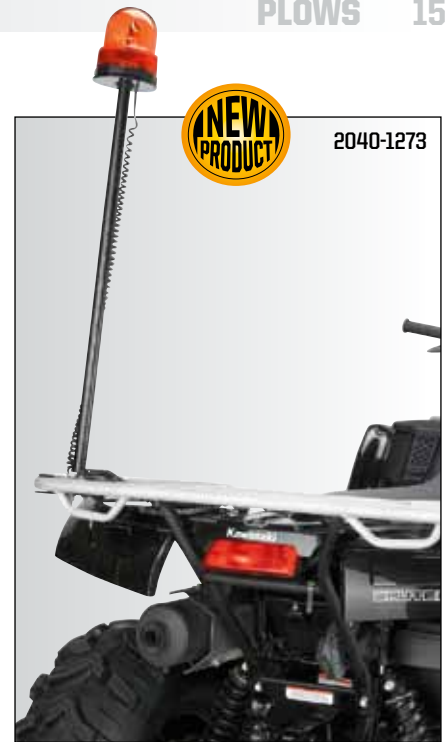

2040-1273

PULLEY KIT > \$11.95-\$39.95

Recommended to use with all RM4 plow kits. Eases lifting the plow, extends winch cable life and provides smooth operation. Simple installation bolts on top of the position pin assembly. Strong steel powdercoated brackets work with all RM4 and Standard plow systems. Features a roller bearing for consistent, smooth operation. Adjustable nylon attachment strap prevents scratching. All hardware and instructions included. Made in the USA.

DESCRIPTION	PART #
PULLEY KIT	4501-0387
REPLACEMENT PULLEY (2-PK)	4501-0432



4501-0387



PLOWS

WINCHES

UTV

RACKS

LUGGAGE

BODY

CONTROLS

ELECTRICAL

WHEELS & TIRES

SUSPENSION & DRIVE

ENGINE

NRA BY MOOSE

RIDER

TOWING

GARAGE

PROMO

PLOW MOUNTING HARDWARE

WHAT TO ORDER:

1. A plow blade (Moose blade 42", 50", 55", 60" or 72" or County blade 50" or 60".)
2. A bottom mount specific to your ATV.
3. A universal lift push tube (part # M93-11001.)
4. A blade lift system (either a winch and winch mount, universal hand lift or an electric plow lift.)

FITS MODEL	EXT. LIFT BOTTOM MOUNT PART #	UNIVERSAL PUSH TUBE PART #	OPTION 1: UNIVERSAL HAND LIFT PART #	OPTION 2: WINCH MOUNT PART #	OPTION 3: ELECTRIC LIFT PART #
ARCTIC CAT					
250 4X4 01	4501-0013	M93-11001	4501-0427	4505-0391	4501-0309
300 4X4 MRP 5-SPEED 04-05	4501-0013	M93-11001	4501-0427	4505-0392	4501-0309
300 4X4 98-01	4501-0013	M93-11001	4501-0427	4505-0391	4501-0309
300 5-SPEED 3-RANGE 4X4 02-03	4501-0013	M93-11001	4501-0427	4505-0392	4501-0309
350 4X4 12	4501-0079	M93-11001	4501-0427	4505-0357	4501-0309
366 4X4 08-09	4501-0079	M93-11001	4501-0427	4505-0357	4501-0309
375 AUTOMATIC 4X4 02	4501-0013	M93-11001	4501-0427	4505-0392	4501-0309
400 4X4 98-01	4501-0013	M93-11001	4501-0427	4505-0391	4501-0309
400 4X4 06-11	4501-0013	M93-11001	4501-0427	4505-0356	4501-0309
400 4X4 02-05	4501-0013	M93-11001	4501-0427	4505-0392	4501-0309
400 4X4 TBX 04	4501-0013	M93-11001	4501-0427	4505-0392	4501-0309
400 4X4 TRV 06-10	4501-0013	M93-11001	4501-0427	4505-0356	4501-0309
425 I 4X4 12	4501-0079	M93-11001	4501-0427	4505-0357	-
450 4X4 11	4501-0013	M93-11001	4501-0427	4505-0356	4501-0309
454 4X4 BEAR CAT 96-98	4501-0013	M93-11001	4501-0427	4505-0391	4501-0309
500 4X4 99-01	4501-0013	M93-11001	4501-0427	4505-0391	4501-0309
500 4X4 02-04	4501-0013	M93-11001	4501-0427	4505-0392	4501-0309
500 4X4 06-13	4501-0013	M93-11001	4501-0427	4505-0356	4501-0309
500 4X4 TBX/TRV 03-05	4501-0013	M93-11001	4501-0427	4505-0392	4501-0309
550 4X4 09-13	4501-0013	M93-11001	4501-0427	4505-0356	4501-0309
550 TRV-2 UP 09-12	4501-0013	M93-11001	4501-0427	4505-0356	4501-0309
650 4X4 04	4501-0013	M93-11001	4501-0427	4505-0392	4501-0309
650 4X4 05-10	4501-0013	M93-11001	4501-0427	4505-0356	4501-0309
650 4X4 MUD PRO 10	4501-0013	M93-11001	4501-0427	-	4501-0309
650 TBX 07	4501-0013	M93-11001	4501-0427	4505-0356	4501-0309
700 4X4 07-13	4501-0013	M93-11001	4501-0427	4505-0356	4501-0309
700 4X4 MUD PRO 10-12	4501-0013	M93-11001	4501-0427	-	4501-0309
700 4X4 TBX 13	4501-0013	M93-11001	4501-0427	4505-0356	4501-0309
550 PROWLER 09	4501-0192	M93-11001	-	4505-0405 ¹	-
550 PROWLER 10-12	4501-0192	M93-11001	-	-	-
650 PROWLER 06-09	4501-0192	M93-11001	-	4505-0405 ¹	-
700 PROWLER 08-09	4501-0192	M93-11001	-	4505-0405 ¹	-
700 PROWLER 10-13	4501-0192	M93-11001	-	4505-0465	-
1000 PROWLER 09	4501-0192	M93-11001	-	4505-0405 ¹	-
1000 PROWLER 10-12	4501-0192	M93-11001	-	4505-0465	-
1000 THUNDERCAT 08	4501-0013	M93-11001	4501-0427	4505-0356	4501-0309
BOBCAT					
3400 12	-	-	-	4505-0497	-
CAN-AM					
OUTLANDER 330 H.O. 4X4 04-08	4501-0422	M93-11001	4501-0427	4505-0361	4501-0309
OUTLANDER MAX 400 4X4 08-12	4501-0422	M93-11001	4501-0427	4505-0361	4501-0309
OUTLANDER 400 4X4 03-13	4501-0422	M93-11001	4501-0427	4505-0361	4501-0309
RENEGADE 500 4X4 07-13	4501-0422	M93-11001	4501-0427	-	4501-0309
TRAXTER 500 03-05	M93-67002	M93-11001	4501-0427	4505-0362	4501-0309
TRAXTER MAX 500 03-04	M93-67002	M93-11001	4501-0427	4505-0362	4501-0309
TRAXTER & XL 500 4X4 99-03	M93-67002	M93-11001	4501-0427	4505-0362	4501-0309
OUTLANDER 500 MAX 07-12	4501-0422	M93-11001	4501-0427	4505-0359	4501-0309
OUTLANDER 500 07-12	4501-0422	M93-11001	4501-0427	4505-0359	4501-0309
OUTLANDER 500 13	4501-0422	M93-11001	4501-0427	-	4501-0309
OUTLANDER 650 & MAX 06-13	4501-0422	M93-11001	4501-0427	4505-0359	4501-0309
QUEST 650 XT 4X4 02-03	M93-67002	M93-11001	4501-0427	4505-0362	4501-0309
TRAXTER MAX XT 650 4X4 05	M93-67002	M93-11001	4501-0427	-	4501-0309
OUTLANDER 800 06-11	4501-0422	M93-11001	4501-0427	4505-0359	4501-0309
OUTLANDER 800 12-13	4501-0422	M93-11001	4501-0427	-	4501-0309
OUTLANDER 800 MAX 06-11	4501-0422	M93-11001	4501-0427	4505-0359	4501-0309
OUTLANDER 800 MAX 12-13	4501-0422	M93-11001	4501-0427	4505-0359	4501-0309
RENEGADE 800 4X4 07-11	4501-0422	M93-11001	4501-0427	-	4501-0309
MAVERICK 1000 13	-	-	-	4505-0521	-
OUTLANDER 1000R 12-13	4501-0422	M93-11001	4501-0427	-	4501-0309
RENEGADE 1000 XC 4X4 12	4501-0422	M93-11001	4501-0427	-	4501-0309
COMMANDER 800 11-13	4501-0316	M93-11001	-	4505-0437	-
COMMANDER 1000 11-13	4501-0316	M93-11001	-	4505-0437	-
CF MOTO					
X5 500 4X4 12-13	4501-0106	M93-11001	4501-0427	-	4501-0309
X6 600 4X4 12	4501-0106	M93-11001	4501-0427	-	4501-0309
X8 800 4X4 12	4501-0436	M93-11001	4501-0427	-	4501-0309

CONTINUED ON NEXT PAGE

PLOW MOUNTING HARDWARE

FITS MODEL	EXT. LIFT BOTTOM MOUNT PART #	UNIVERSAL PUSH TUBE PART #	OPTION 1: UNIVERSAL HAND LIFT PART #	OPTION 2: WINCH MOUNT PART #	OPTION 3: ELECTRIC LIFT PART #
HONDA					
TRX250 RECON 2X4/ES 97-13	M93-61001	M93-11001	4501-0427	4505-0384	4501-0309
TRX300 2X4/4X4 93-00	M93-61001	M93-11001	4501-0427	4505-0388	4501-0309
TRX350 S/ES 2X4/4X4 RANCHER 00-06	4501-0043	M93-11001	4501-0427	4505-0387	4501-0309
TRX400AT S/ES 4X4 RANCHER 04-07	4501-0043	M93-11001	4501-0427	4505-0387	4501-0309
TRX400 FOREMAN 4X4 95-01	4501-0043	M93-11001	4501-0427	4505-0379	4501-0309
TRX420 EFI RANCHER 07-13	4501-0203	M93-11001	4501-0427	4505-0360 ²	4501-0309
TRX450S/ES FOREMAN 4X4 98-04	4501-0043	M93-11001	4501-0427	4505-0379	4501-0309
TRX500 4X4 RUBICON/GPS 01-04	M93-61004	M93-11001	4501-0427	4505-0380	4501-0309
TRX500 FOREMAN RUBICON & GPSCAPE 05-06	4501-0043	M93-11001	4501-0427	4505-0365	4501-0309
TRX500 FOREMAN RUBICON & GPSCAPE 07-08	4501-0043	M93-11001	4501-0427	4505-0366	4501-0309
TRX500 FOREMAN RUBICON & GPSCAPE 09-13	4501-0043	M93-11001	4501-0427	4505-0355	4501-0309
TRX500 FOREMAN ES 05-06	4501-0043	M93-11001	4501-0427	4505-0364	4501-0309
TRX500 FOREMAN ES 07-08	4501-0043	M93-11001	4501-0427	4505-0366	4501-0309
TRX500 FOREMAN ES 09-11	4501-0043	M93-11001	4501-0427	4505-0355	4501-0309
TRX500 FOREMAN 12-13	4501-0412	M93-11001	4501-0427	4505-0455	4501-0309
TRX650 4X4 RINCON/GPS 03-05	M93-61006	M93-11001	4501-0427	4505-0363	4501-0309
TRX680 4X4 RINCON/GPS 06-13	M93-61006	M93-11001	4501-0427	4505-0363	4501-0309
BIG RED 09-13	4501-0224	M93-11001	-	4505-0406	-
JOHN DEERE					
GATOR XUV 550 12	4501-0428	M93-11001	-	4505-0506	-
GATOR XUV 620I 09	4501-0423	M93-11001	-	-	-
GATOR XUV 825I 11	4501-0423	M93-11001	-	4505-0466	-
GATOR RSX 850I 12-13	4501-0431	M93-11001	-	4505-0506	-
GATOR XUV 855D 13	4501-0423	M93-11001	-	4505-0466	-
KAWASAKI					
KLF250 BAYOU 2X4 02-06	4501-0079	M93-11001	4501-0427	-	4501-0309
KVF300 PRAIRIE 4X4 99-02	M93-62004	M93-11001	4501-0427	-	4501-0309
KVF360 PRAIRIE 4X4 03-11	M93-62006	M93-11001	4501-0427	4505-0367	4501-0309
KLF300 BAYOU 4X4 89-02	M93-62001	M93-11001	4501-0427	-	4501-0309
KVF400 PRAIRIE 4X4 97-02	M93-62003	M93-11001	4501-0427	-	4501-0309
BRUTE FORCE 300 12	-	-	-	4505-0522	-
BRUTE FORCE 650(STRAIGHT AXLE) 05	M93-62005	M93-11001	4501-0427	-	4501-0309
BRUTE FORCE 650(STRAIGHT AXLE) 06-13	M93-62005	M93-11001	4501-0427	4505-0368	4501-0309
BRUTE FORCE 650 (IRS) 06	4501-0028	M93-11001	4501-0427	-	4501-0309
BRUTE FORCE 650 (IRS) 07-09	4501-0028	M93-11001	4501-0427	4505-0373	4501-0309
BRUTE FORCE 650 (IRS) 10-11	4501-0028	M93-11001	4501-0427	4505-0376	4501-0309
KVF650 PRAIRIE 4X4 02-03	M93-62005	M93-11001	4501-0427	4505-0369	4501-0309
KVF700 PRAIRIE 4X4 04-06	M93-62005	M93-11001	4501-0427	4505-0369	4501-0309
KFX700 04-09	4501-0079	M93-11001	4501-0427	-	4501-0309
BRUTE FORCE 750 IRS 4X4 05-13	4501-0028	M93-11001	4501-0427	4505-0376	4501-0309
TERYX 750 08-13	4501-0188	M93-11001	-	4505-0401 ³	-
TERYX 750 4 12	4501-0188	M93-11001	-	4505-0401 ³	-
TERYX 750 4 13	4501-0188	M93-11001	-	-	-
MULE 610 05-13	4501-0193	M93-11001	-	4505-0400	-
3010 MULE DIESEL 05-06	4501-0194	M93-11001	-	4505-0399 ^{1,4}	-
3010 MULE 4-DOOR 07-08	4501-0194	M93-11001	-	4505-0399 ^{1,4}	-
3010 MULE 05-08	4501-0194	M93-11001	-	4505-0399 ^{1,4}	-
4010 MULE 09-13 (NOT FOR DIESELS)	4501-0194	M93-11001	-	4505-0398 ¹	-
KUBOTA					
RTV400/500 12	-	-	-	4505-0502	-
RTV900 08-13	-	-	-	4505-0467	-
KYMCO					
375 MXU 4X4 09	4501-0079	M93-11001	4501-0427	-	4501-0309
500 4X4 07-08	4501-0106	M93-11001	4501-0427	-	4501-0309
POLARIS					
XPLORER 250 4X4 00-01	M93-68004	M93-11001	4501-0427	-	4501-0309
XPLORER 300 4X4 96-99	M93-68004	M93-11001	4501-0427	4505-0393	4501-0309
HAWKEYE 300 06	4501-0060	M93-11001	4501-0427	-	4501-0309
SPORTSMAN 300 08	4501-0060	M93-11001	4501-0427	4505-0395	4501-0309
MAGNUM 325 4X4 00-01	M93-68004	M93-11001	4501-0427	4505-0393	4501-0309
MAGNUM 325 4X4 02	M93-68007	M93-11001	4501-0427	4505-0393	4501-0309
TRAIL BLAZER 330 08-11	M93-68006	M93-11001	4501-0427	-	4501-0309
TRAIL BOSS 330 09	M93-68006	M93-11001	4501-0427	-	4501-0309
TRAIL BOSS 330 04-08	M93-68004	M93-11001	4501-0427	-	4501-0309
ATP 330 4X4 04	M93-68007	M93-11001	-	4505-0393	4501-0309
MAGNUM 330 4X4 03-04	M93-68007	M93-11001	4501-0427	4505-0393	4501-0309
MAGNUM 330 2X4 05	M93-68007	M93-11001	4501-0427	-	4501-0309
SPORTSMAN 335 4X4 98-00	M93-68004	M93-11001	4501-0427	4505-0393	4501-0309
SPORTSMAN 400 4X4 94-97	M93-68003	M93-11001	4501-0427	4505-0390	4501-0309
SPORTSMAN 400 4X4 01-03	M93-68004	M93-11001	4501-0427	4505-0393	4501-0309
SPORTSMAN 400 4X4 04	M93-68004	M93-11001	4501-0427	4505-0394	4501-0309

CONTINUED ON NEXT PAGE

PLOWS

WINCHES

UTV

RACKS

LUGGAGE

BODY

CONTROLS

ELECTRICAL

WHEELS & TIRES

SUSPENSION & DRIVE

ENGINE

NRA BY MOOSE

RIDER

TOWING

GARAGE

PROMO

PLOW MOUNTING HARDWARE

FITS MODEL	EXT. LIFT BOTTOM MOUNT PART #	UNIVERSAL PUSH TUBE PART #	OPTION 1: UNIVERSAL HAND LIFT PART #	OPTION 2: WINCH MOUNT PART #	OPTION 3: ELECTRIC LIFT PART #
POLARIS (CON'T)					
SPORTSMAN 400 4X4 05	4501-0033	M93-11001	4501-0427	4505-0394	4501-0309
SPORTSMAN 400 4X4 08-10	4501-0060	M93-11001	4501-0427	4505-0395	4501-0309
SPORTSMAN 400 4X4 11-13	4501-0033	M93-11001	4501-0427	4505-0396	4501-0309
XPLORER 400L 4X4 95-02 #2907011 & LATER	M93-68004	M93-11001	4501-0427	4505-0393	4501-0309
BIG BOSS 400L 6X6 95-98	M93-68003	M93-11001	4501-0427	4505-0390	4501-0309
XPLORER 400L 4X4 95 #2906001-2907010	M93-68003	M93-11001	4501-0427	4505-0393	4501-0309
XPEDITION 425 4X4 00	M93-68004	M93-11001	4501-0427	4505-0393	4501-0309
MAGNUM 425 4X4 95-98	M93-68003	M93-11001	4501-0427	4505-0390	4501-0309
MAGNUM 425 6X6 95-96	M93-68003	M93-11001	4501-0427	4505-0390	4501-0309
SPORTSMAN 450 06-07	4501-0033	M93-11001	4501-0427	4505-0394	4501-0309
DIESEL 455 4X4 99-00	M93-68004	M93-11001	4501-0427	4505-0393	4501-0309
ATP 500 H.O. 4X4 04-05	M93-68007	M93-11001	4501-0427	4505-0393	4501-0309
SPORTSMAN 500 4X4 96-03	M93-68004	M93-11001	4501-0427	4505-0393	4501-0309
SPORTSMAN 500 4X4 04	M93-68004	M93-11001	4501-0427	4505-0394	4501-0309
SPORTSMAN 500 4X4 05-10	4501-0033	M93-11001	4501-0427	4505-0394	4501-0309
SPORTSMAN 500 4X4 11-13	4501-0033	M93-11001	4501-0427	4505-0396	4501-0309
SPORTSMAN 500 4X4 X2 08	4501-0100	M93-11001	4501-0427	4505-0385	4501-0309
SPORTSMAN 500 4X4 X2/TOURING 07-09	4501-0100	M93-11001	4501-0427	4505-0394	4501-0309
SPORTSMAN 500 6X6 00-02	M93-68004	M93-11001	4501-0427	4505-0393	4501-0309
SPORTSMAN 500 6X6 03-08	M93-68006	M93-11001	4501-0427	4505-0393	4501-0309
MAGNUM 500 4X4 99-00	M93-68004	M93-11001	4501-0427	4505-0393	4501-0309
MAGNUM R.M.K. 500 4X4 01	M93-68004	M93-11001	4501-0427	-	4501-0309
BIG BOSS 500 6X6 98-99	M93-68003	M93-11001	4501-0427	4505-0390	4501-0309
XPLORER 500 4X4 97	M93-68004	M93-11001	4501-0427	4505-0393	4501-0309
SPORTSMAN 550 XP 09-13	4501-0204	M93-11001	4501-0427	4505-0396	4501-0309
SPORTSMAN 550 X2/TOURING 10-12	4501-0204	M93-11001	4501-0427	4505-0396	4501-0309
SPORTSMAN 600 4X4 03-05	M93-68006	M93-11001	4501-0427	4505-0394	4501-0309
SPORTSMAN 700 4X4 02-07	M93-68006	M93-11001	4501-0427	4505-0394	4501-0309
SPORTSMAN 700 MV7 4X4 05	M93-68006	M93-11001	-	-	4501-0309
SPORTSMAN 700 4X4 X2 06-07	4501-0100	M93-11001	4501-0427	4505-0385	4501-0309
SPORTSMAN 800 X2 07-09	4501-0100	M93-11001	4501-0427	4505-0394	4501-0309
SPORTSMAN 800 4X4 05-10	M93-68006	M93-11001	4501-0427	4505-0394	4501-0309
SPORTSMAN 800 4X4 11-13	4501-0033	M93-11001	4501-0427	4505-0396	4501-0309
SPORTSMAN 800 TOURING 08	4501-0100	M93-11001	4501-0427	4505-0394	4501-0309
SPORTSMAN 850 XP 09-13	4501-0204	M93-11001	4501-0427	4505-0396	4501-0309
SPORTSMAN 850 XP TOURING 11-13	4501-0204	M93-11001	4501-0427	4505-0396	4501-0309
RANGER 400 4X4 10-13	4501-0192	M93-11001	-	4505-0436	-
RANGER 500 6X6/4X4 05-08	4501-0192	M93-11001	-	4505-0403	-
RANGER 500 4X4 09-10	4501-0195	M93-11001	-	4505-0407	-
RANGER 500 4X4 11-12 (INCLUDING CREW MODELS)	4501-0192	M93-11001	-	4505-0436	-
RANGER 700 4X4 (XP) 05-08	4501-0192	M93-11001	-	4505-0403	-
RANGER 700 4X4 (XP) 09	4501-0195	M93-11001	-	4505-0407	-
RANGER 700 6X6 09	4501-0192	M93-11001	-	4505-0403	-
RANGER 800 4X4 10-13	4501-0195	M93-11001	-	4505-0407	-
RANGER 800 4X4 13 (MIDSIZE)	4501-0192	M93-11001	-	-	-
RANGER 900 13	4501-0430	M93-11001	-	4505-0505	-
RANGER DIESEL 11	4501-0195	M93-11001	-	4505-0407	-
RZR 570 12-13	4501-0192	M93-11001	-	4505-0404 ¹	-
RZR/RZR-S/RZR-4 800 08-13	4501-0192	M93-11001	-	4505-0404 ¹	-
RZR 900 XP/ RZR-4 900 11-13	4501-0416	M93-11001	-	4505-0458 ¹	-
SUZUKI					
LTF 250 QUADRUNNER 99-01	M93-63003	M93-11001	4501-0427	-	4501-0309
LT4WD, LTF 250 90-98	M93-63001	M93-11001	4501-0427	4505-0377	4501-0309
LTF 280X/300 KING QUAD 91-98	M93-63001	M93-11001	4501-0427	4505-0377	4501-0309
LTF 300 KING QUAD 99-02	M93-63003	M93-11001	4501-0427	-	4501-0309
QUADRUNNER EIGER MANUAL/AUTO 400 4X4 02-07	4501-0013	M93-11001	4501-0427	4505-0386	4501-0309
KING QUAD 400 08-13	4501-0013	M93-11001	4501-0427	4505-0397	4501-0309
KING QUAD 450 07-10	4501-0040	M93-11001	4501-0427	4505-0378 ⁵	4501-0309
KING QUAD 500 09-13	4501-0040	M93-11001	4501-0427	4505-0378 ⁵	4501-0309
LTF 500 QUADRUNNER 98-02	4501-0013	M93-11001	4501-0427	-	4501-0309
QUADRUNNER VINSON 500 MANUAL/AUTO 02-07	4501-0013	M93-11001	4501-0427	4505-0386	4501-0309
TWIN PEAKS 700 04-05	M93-62005	M93-11001	4501-0427	4505-0369	4501-0309
KING QUAD 700 05-07	4501-0040	M93-11001	4501-0427	4505-0378 ⁵	4501-0309
KING QUAD 750 08-13	4501-0040	M93-11001	4501-0427	4505-0378 ⁵	4501-0309
YAMAHA					
GRIZZLY 300 12	-	-	-	4505-0478	-
GRIZZLY 350 07-13 (IRS)	M93-64008	M93-11001	4501-0427	4505-0381	4501-0309
BRUIN 350 4X4 04-06	M93-64008	M93-11001	4501-0427	4505-0381	4501-0309
WOLVERINE 350 4X4 95-05	M93-64005	M93-11001	4501-0427	4505-0389	4501-0309
WOLVERINE 350 4X4 07-09	M93-64008	M93-11001	4501-0427	4505-0383	4501-0309
BIG BEAR 350 4X4 94-96	M93-64003	M93-11001	4501-0427	-	4501-0309

CONTINUED ON NEXT PAGE

PLOW MOUNTING HARDWARE

FITS MODEL	EXT. LIFT BOTTOM MOUNT PART #	UNIVERSAL PUSH TUBE PART #	OPTION 1: UNIVERSAL HAND LIFT PART #	OPTION 2: WINCH MOUNT PART #	OPTION 3: ELECTRIC LIFT PART #
YAMAHA (CON'T)					
BIG BEAR 350 4X4 97-99	M93-64005	M93-11001	4501-0427	-	4501-0309
YFM400 BIG BEAR 4X4 00-06	M93-64005	M93-11001	4501-0427	4505-0372	4501-0309
YFM400 BIG BEAR 4X4 07-11	4501-0104	M93-11001	4501-0427	4505-0382	4501-0309
YFM400 KODIAK FWT 93-98	M93-64003	M93-11001	4501-0427	-	4501-0309
KODIAK 400 99	M93-64005	M93-11001	4501-0427	-	4501-0309
KODIAK 400 ULTRAMATIC 00-02	M93-64008	M93-11001	4501-0427	4505-0371	4501-0309
KODIAK 400 4X4 03-05	M93-64008	M93-11001	4501-0427	4505-0381	4501-0309
GRIZZLY 450 07-08	M93-64008	M93-11001	4501-0427	4505-0381	4501-0309
GRIZZLY 450 09-13	M93-64008	M93-11001	4501-0427	4505-0358 ²	4501-0309
KODIAK 450 4X4 & AUTO 03-06	M93-64008	M93-11001	4501-0427	4505-0381	4501-0309
WOLVERINE 450 06-10	M93-64008	M93-11001	4501-0427	4505-0383	4501-0309
GRIZZLY 550 09-13	M93-64017	M93-11001	4501-0427	4505-0375	4501-0309
GRIZZLY 600 98-01	M93-64004	M93-11001	4501-0427	4505-0370	4501-0309
GRIZZLY 660 02-08	M93-64017	M93-11001	4501-0427	4505-0374	4501-0309
GRIZZLY 700 EFI 07-13	M93-64017	M93-11001	4501-0427	4505-0375	4501-0309
RHINO 450 06-09	4501-0188	M93-11001	-	4505-0402	-
RHINO 660 06-07	4501-0188	M93-11001	-	4505-0402	-
RHINO 700 08-13	4501-0188	M93-11001	-	4505-0402	-

¹ WILL NOT WORK WITH WARN 4000LB WINCH ² WILL NOT WORK WITH MOOSE 3700LB WINCH OR SUPERWINCH TERRA SERIES ³ ONLY WORKS WITH WARN 2500, 3000 AND 4000LB WINCHES
⁴ ONLY FOR 2-BOLT WINCHES ⁵ MUST USE WITH MOOSE FAIRLEAD; M91-50070



- PLOWS
- WINCHES
- UTV
- RACKS
- LUGGAGE
- BODY
- CONTROLS
- ELECTRICAL
- WHEELS & TIRES
- SUSPENSION & DRIVE
- ENGINE
- NRA BY MOOSE
- RIDER
- TOWING
- GARAGE
- PROMO



TIRE CHAINS > \$40.95-\$67.95

V-bar tire chains are available for virtually any ATV. They provide extra pushing/pulling power for any job. Four sizes make installation easy. Applications are for rear tires unless noted. Tire chains are packaged in a plastic, tackle box style storage case; sold in pairs. Note: Always check clearance after installation. Imported.

TIRE SIZE	TIRE MFG.	TIRE MODEL #	PART #
20X10.00-9	DUNLOP	KT185B	M91-60008
21X10.00-8	DURO	AT	M91-60008
22X10.00-10	DUNLOP	KT705,KT765A,KT857	M91-60008
22X10.00-10	CHENG SHIN	AT	M91-60008
22X10.00-10	KENDA	PATHFINDER AT	M91-60008
22X10.00-8	DUNLOP	K1537	M91-60008
22X10.00-8	MAXXIS	MAVERICK	M91-60008
22X10.00-9	DUNLOP	KT155,KT175,KT775B	M91-60008
22X10.00-9	GOODYEAR	HP	M91-60008
22X10.00-9	OHTSU	P/V702	M91-60008
22X11.00-10	DUNLOP	KT406A	M91-60008
22X11.00-10	TITAN	AT489	M91-60008
22X11.00-10	GOODYEAR	WRANGLERSPORT	M91-60008
22X11.00-10	GOODYEAR/TITAN	TERRA	M91-60008
22X11.00-10	CARLISLE	BADLANDS	M91-60009
22X11.00-10	DUNLOP	KT765,KT869,KT869A	M91-60009
22X11.00-10	ITP	HOLESHOT XCT	M91-60009
22X11.00-8	BRIDGESTONE	MHO2,MHO2A	M91-60008
22X11.00-8	DUNLOP	KT517,KT529	M91-60008
22X11.00-8	IRC	EL08	M91-60008
22X11.00-8	OHTSU	H-TRAK,PRO-VECTOR 301	M91-60008
22X11.00-9	DUNLOP	KT827	M91-60008
22X7.00-10	MAXXIS	AT	M91-60008
22X9.00-10	OHTSU	H-TRAK P/V702	M91-60008
22X9.00-8	GOODYEAR	ATT 902	M91-60008
23X8-10	DUNLOP	KT401	M91-60008
23X8-10	DUNLOP	KT405	M91-60008
23X10.00-12	DUNLOP	KT407	M91-60008
23X10.00-12	MAXXIS	LYNX	M91-60009
23X11.00-10	DUNLOP	KT869	M91-60010
23X8.00-11	OHTSU	A/T 504	M91-60008
24X10.00-11	BRIDGESTONE	DIRTHOOKS 14	M91-60009
24X10.00-11	DUNLOP	KT962A,KY962	M91-60009
24X10.00-11	GOODYEAR	TRACKER ATT,TRACKER MP	M91-60010
24X10.00-12	DUNLOP	KT405H	M91-60010
24X11.00-10	DUNLOP	KT765,KT869	M91-60009
24X11.00-10	GOODYEAR	WRANGLERSPORT	M91-60009
24X11.00-10	TITAN	AT489	M91-60009
24X11.00-10	DURO	EXCAVATOR	M91-60010
24X11.00-12	CARLISE	AT489	M91-60009
24X11.00-12	TITAN	AT489	M91-60009
24X11.00-9	BRIDGESTONE	DIRT HOOK-10	M91-60010
24X11.5-10	TITAN	AT489	M91-60010
24X12.00-12	DUNLOP	KT405H	M91-60010
24X13.00-9	DUNLOP	KT724	M91-60010
24X8.00-11	GOODYEAR	TRACKER ATT	M91-60008
24X9.00-11	BRIDGESTONE	DIRT HOOK	M91-60009
24X9.00-11	GOODYEAR	ATT 913	M91-60009



REPLACEMENT TIRE CHAIN CASE > \$4.95

Imported.

DESCRIPTION	PART #
REPLACEMENT TIRE CHAIN CASE	0366-0003

- 8-V BAR – 14.5" WX 52" L (M91-60008)
- 9-V BAR – 14.5" WX 54" L (M91-60009)
- 10-V BAR – 17" WX 56" L (M91-60010)
- 11-V BAR – 17" WX 66" L 0366-0002) (For use on 20" & 28" tires)

TIRE SIZE	TIRE MFG.	TIRE MODEL #	PART #
24X9.00-11	OHTSU	A/T 502,H-TRAC A/T	M91-60009
24X9.00-12	TITAN	AT480,AT489	M91-60009
25X10.00-10	DURO	AT	M91-60008
25X10.00-10	DUNLOP	KT126	M91-60010
25X10.00-11	DUNLOP	KT405B	M91-60010
25X10.00-12	DUNLOP	KT127,KT135	M91-60009
25X10.00-12	TITAN	AT489	M91-60009
25X10.00-12	BRIDGESTONE	DIRTHOOK	M91-60010
25X10.00-12	CARLISLE	TRAILWOLF	M91-60010
25X10.00-12	DUNLOP	AT,KT125,KT127,KT127A,KT135,KT185,KT195,KT405A,KT405C,KT405D,KT405E,KT405H,KT406,KT415,KT645,KT955,KT127	M91-60010
25X10.00-12	GY	RAWHIDE RS	M91-60010
25X10.00-12	KENDA	RADIAL BOUNTY HUNT	M91-60010
25X10.00-12	MAXXIS	AT, M912V,NHS	M91-60010
25X10.00-12	OHTSU	H-TRAK,H-TRAK ZA602,U/R 301,ZA602	M91-60010
25X10.00-13	DUNLOP	KT405G	M91-60010
25X11.00-10	TITAN	AT489	M91-60008
25X11.00-10	DUNLOP	KT125,KT125M,KT905	M91-60010
25X11.00-10	GOODYEAR	TRACKER CL, TRACKER P	M91-60010
25X11.00-12	CARLISLE	TRAILWOLF	M91-60008
25X11.00-12	CARLISLE	ACT,AT489,BADLANDS XTR, TRAILWOLF	M91-60010
25X11.00-12	DUNLOP	KT127,KT127B	M91-60010
25X11.00-12	GOODYEAR	RAWHIDE, RAWHIDE GRIP	M91-60010
25X11.00-12	OHTSU	H-TRAK ZA601	M91-60010
25X11.00-12	TITAN	AT489	M91-60010
25X11.00-9	DUNLOP	KT687	M91-60008
25X11.00-9	GOODYEAR	ATT 912	M91-60009
25X12.00-10	DUNLOP	KT121,KT125,KT125M,KT825	M91-60010
25X12.00-10	GOODYEAR	TRACKER P	M91-60010
25X12.00-12	DUNLOP	KT127B	M91-60010
25X12.00-9	DUNLOP	KT430	M91-60009
25X12.00-9	BRIDGESTONE	DIRTHOOK-04	M91-60010
25X12.00-9	DUNLOP	KT405,KT565,KT725M	M91-60010
25X12.00-9	MAXXIS		M91-60010
25X12.00-9	OHTSU	H-TRAC 501,H-TRAC-II,PRO/AM 501	M91-60010
25X8.00-12	BRIDGESTONE	DIRT HOOK	M91-60008
25X8.00-12	CARLISLE	ACT,TRAILWOLF	M91-60008
25X8.00-12	DUNLOP	KT401A,KT401C	M91-60008
25X8.00-12	DUNLOP	KT121,KT191,KT402,KT404,KT951	M91-60009
25X8.00-12	GY	RAWHIDE RS	M91-60009
26X10.00-12	CARLISLE	TRAILWOLF	M91-60010
26X10.00-12	OHTSU	ZA601SP	M91-60010
26X10.5-12	TITAN	AT495	M91-60010
26X11.00-12	GOODYEAR	RAWHIDE MT/R	M91-60010
26X11.00-12	POLARIS	PXT	M91-60010



4000 LB WINCH > \$419.95-\$519.95
 4000 lb capacity. For UTV's only. Three stage planetary gear train. Available in both wire rope and synthetic rope. Wire and synthetic rope are both 55' of 7/32" cable. Internal freespool clutch. Mechanical spring brake. Comes with plow style roller fairlead. Mini rocker switch and corded remote & socket included. Made in the USA.

DESCRIPTION	PART #
4000 LB WITH WIRE ROPE	4505-0483
4000 LB WITH SYNTHETIC ROPE	4505-0484

REPLACEMENT PARTS > \$36.95-\$148.95

DESCRIPTION	PART #
WIRE ROPE	4505-0438
SYNTHETIC ROPE	4505-0439
CONTACTOR	4505-0513
ROCKER SWITCH	4505-0514

3000 LB WINCH > \$369.95-\$439.95
 3000 lb capacity. Three stage planetary gear train. Available in both wire rope and synthetic rope. Wire and synthetic rope are both 50' of 5/32" cable. Internal freespool clutch. Mechanical spring brake. Comes with plow style roller fairlead. Mini rocker switch and corded remote & socket included. Made in the USA.

DESCRIPTION	PART #
3000 LB WITH WIRE ROPE	4505-0481
3000 LB WITH SYNTHETIC ROPE	4505-0482

REPLACEMENT PARTS > \$51.95-\$82.95

DESCRIPTION	PART #
WIRE ROPE	W60076
SYNTHETIC ROPE	4505-0313
CONTACTOR	4505-0513
ROCKER SWITCH	W64851



2000 LB WINCH > \$259.95-\$329.95
 2000 lb capacity. Differential planetary gear train. Available in both wire rope and synthetic rope. Wire and synthetic rope are both 50' of 5/32" cable. Internal freespool clutch. Mechanical spring brake. Comes with plow style roller fairlead. Mini rocker switch included. Made in the USA.

DESCRIPTION	PART #
2000 LB WITH WIRE ROPE	4505-0479
2000 LB WITH SYNTHETIC ROPE	4505-0480

REPLACEMENT PARTS > \$37.95-\$78.95

DESCRIPTION	PART #
WIRE ROPE	4505-0510
SYNTHETIC ROPE	4505-0511
CONTACTOR	4505-0512
ROCKER SWITCH	W64851

PLOWS
 WINCHES
 UTV
 RACKS
 LUGGAGE
 BODY
 CONTROLS
 ELECTRICAL
 WHEELS & TIRES
 SUSPENSION & DRIVE
 ENGINE
 NRA BY MOOSE
 RIDER
 TOWING
 GARAGE
 PROMO



3700 LB WINCH > \$342.95

3700 lbs of rated pull. 50' x 13/64" wire rope. Handlebar mounted toggle switch and a heavy-duty sealed relay. Includes 6' hand-held remote and socket. Free spooling clutch. Color coded wiring for easy installation. Imported.

DESCRIPTION	PART #
3700 LB WINCH	4505-0408

REPLACEMENT PARTS	PART #
WIRE ROPE	4505-0441
ROCKER SWITCH	4505-0520



LARGE ROLLER FAIRLEAD > \$31.95

Designed for use with winches that primarily raise and lower the ATV plow blade. Larger diameter lower roller reduces wear on rope. Imported.

DESCRIPTION	PART #
LARGE ROLLER FAIRLEAD	4505-0294



ROLLER FAIRLEAD > \$29.95

Designed to reduce cable wear, especially on sharp angle pulls. Made in the USA.

DESCRIPTION	PART #
ROLLER FAIRLEAD	M91-50070



RUBBER CABLE STOP > \$9.95

Impact-absorbing rubber prevents bottoming-out of winch. Prevents hook rattling when not in use. A must have for preventing minor damage. Imported.

DESCRIPTION	PART #
WINCH CUSHION	4505-0475



4505-0468



4505-0469

RECEIVER STYLE WINCH CRADLES > \$79.95

Universal receiver mounted winch cradle fits almost any ATV or UTV with a 2" or 1-1/4" receiver hitch. Mount any 2 or 4 bolt pattern winch up to 4500 lbs. Even accepts wide drum winches! Includes hardware and mounting pin/clip. Formed steel construction has built in handles and features a durable powder coat finish. Quick disconnect plugs are included for a truly plug and play setup. Made in the USA.

DESCRIPTION	PART #
2" RECEIVERS	4505-0468
1-1/4" RECEIVERS	4505-0469



3/16" X 50' SYNTHETIC WINCH CABLE > \$84.95

Eliminate wire slivers and extra weight. New synthetic ATV winch cable is safer than traditional wire cable. For aluminum drum winches. Tubular abrasion protector extends rope life. Soft eyelet on working end to easily thread through snatch blocks. 4000 lb working load. For ATV use only. Made in the USA.

DESCRIPTION	PART #
3/16" X 50' SYNTHETIC WINCH CABLE	4505-0343



3/16" X 50' SYNTHETIC WINCH CABLE > \$79.95

Eliminate wire slivers and extra weight. Synthetic ATV winch cable is safer than traditional wire cable. For aluminum drum winches. Tubular abrasion protector extends rope life. Soft eyelet on working end to easily thread through snatch blocks. 4000 lb working load. For ATV use only. Imported.

DESCRIPTION	PART #
BLUE	4505-0498
RED	4505-0499
YELLOW	4505-0500
GREEN	4505-0501

PLOWS
WINCHES
 UTV
 RACKS
 LUGGAGE
 BODY
 CONTROLS
 ELECTRICAL
 WHEELS & TIRES
 SUSPENSION & DRIVE
 ENGINE
 NRA BY MOOSE
 RIDER
 TOWING
 GARAGE
 PROMO

M.U.D.





PROMO
GARAGE
TOWING
RIDER
NRA BY MOOSE
ENGINE
SUSPENSION & DRIVE
WHEELS & TIRES
ELECTRICAL
CONTROLS
BODY
LUGGAGE
RACKS
UTV
WINCHES
PLOWS



PROWLER FULL FOLDING WINDSHIELD > \$8.95-\$322.95

Premium .177" thick clear polycarbonate shield. Centrally binged for ventilation. Tool-less operation. Stainless steel rubber coated mount straps. Rubber seal helps keep elements out. Made in the USA.

FITS MODEL	OVERALL WIDTH	OVERALL HEIGHT	PART#
ARCTIC CAT PROWLER 650 04-10 (SQUARE TUBING)	53.5"	28.25"	2317-0138
ARCTIC CAT PROWLER 650 11-13 (ROUND TUBING)	53.25"	28.75"	2317-0139
REPLACEMENT HOOD PUCKS (2 PIECE)	-	-	2317-0057



PROWLER HALF WINDSHIELD > \$142.95

Premium .177" thick polycarbonate. Stainless steel rubber coated mounting clamps. Rubber seal helps keep elements out.

Made in the USA.

FITS MODEL	OVERALL WIDTH	OVERALL HEIGHT	PART#
ARCTIC CAT PROWLER 650 04-10 (SQUARE TUBING)	53.5"	13.5"	2317-0128
ARCTIC CAT PROWLER 650 11-13 (ROUND TUBING)	53.25"	11.75"	2317-0129



PROWLER FULL CAB ENCLOSURE > \$504.95

Water resistant shell with automotive grade clear flexible acrylic windshield, doors and back window. Doors are completely removable and have full length double pull zippers. Cab comes with self adhesive hook-and-loop closures and installation/care instructions. 40 oz. Tonneau-Tex vinyl material. Made in the USA.



PROWLER ROOF COVER > \$81.95

The roof cap fastens to roll bars with rubber coated nylon webbing with hook-and-loop closures. Roof cap has two straps inside top to keep cover tight and rain from ponding on top of cover. Mossy Oak Break-Up®, 500 denier Cordura® material. Made in the USA.

FITS MODEL	PART #
ARCTIC CAT PROWLER 650 04-10	0521-0564

FITS MODEL	PART #
ARCTIC CAT PROWLER 650 04-10	0521-0561



COMMANDER FULL FOLDING WINDSHIELD > \$8.95-\$322.95

Premium .177" thick clear polycarbonate shield. Centrally hinged for ventilation. Tool-less operation. Stainless steel rubber coated mount straps. Rubber seal helps keep elements out. Made in the USA.

FITS MODEL	OVERALL WIDTH	OVERALL HEIGHT	PART #
CAN-AM COMMANDER ALL 11-13	52.75"	33.5"	2317-0140
REPLACEMENT HOOD PUCKS (2 PIECE)	-	-	2317-0057



COMMANDER HALF WINDSHIELD > \$142.95

Premium .177" thick polycarbonate. Stainless steel rubber coated mounting clamps. Rubber seal helps keep elements out. Made in the USA.

FITS MODEL	OVERALL WIDTH	OVERALL HEIGHT	PART #
CAN-AM COMMANDER ALL 11-13	52.75"	18"	2317-0130



COMMANDER ROOF > \$218.95

Durable polyethylene with UV stabilizers. Extremely durable in cold weather. Comes with all mounting hardware. Two-piece design. Fits all models. Not for trailering. Made in the USA.

FITS MODEL	PART #
CAN-AM COMMANDER 800/1000 11-12	0521-0911



M.U.D.



BIG RED FULL CAB ENCLOSURE > \$519.95

Features water resistant shell with automotive grade clear flexible acrylic windshield, doors and back window. Doors are completely removable and have full length double pull zippers. Cab comes complete with necessary self adhesive hook-and-loop, installation and care instructions. Made in the USA.

DESCRIPTION	PART #
BLACK (40 OZ. TONNEAU-TEX VINYL)	0521-0818
MOSSY OAK BREAK-UP® (500 DENIER CORDURA®)	0521-0819



BIG RED FULL FOLDING WINDSHIELD > \$8.95-\$322.95

Premium .177" thick clear polycarbonate shield. Centrally hinged for ventilation. Tool-less operation. Stainless steel rubber coated mount straps. Rubber seal helps keep elements out. Made in the USA.

FITS MODEL	OVERALL WIDTH	OVERALL HEIGHT	PART #
HONDA BIG RED 09-13	59.375"	31.5"	2317-0141 ¹
REPLACEMENT HOOD PUCKS (2 PIECE)	-	-	2317-0057

¹ NOT FOR USE WITH HONDA OEM ROOF



BIG RED ROOF COVER > \$83.95

Roof cap fastens to roll bars with rubber coated nylon webbing and self adhesive hook-and-loop. Roof cap has two straps inside top to keep cover tight and rain from ponding on top of cover. Perfect to keep you in the shade and out of the rain. Made in the USA.

DESCRIPTION	PART #
BLACK (40 OZ. TONNEAU-TEX VINYL)	0521-0824



BIG RED HALF WINDSHIELD > \$142.95

Premium .177" thick polycarbonate. Stainless steel rubber coated mounting clamps. Rubber seal helps keep elements out. Made in the USA.

FITS MODEL	OVERALL WIDTH	OVERALL HEIGHT	PART #
HONDA BIG RED 09-13	59.375"	13"	2317-0131



BIG RED BATTERY TRAY > \$179.95

Battery tray allows you to upgrade to a high powered battery or add an additional battery to your Big Red. Attaches to frame under your hood (to the right of your stock battery box). Powder coated for superior protection. 9 7/8"L x 7 1/8"W x 6 1/2"H. Includes mounting hardware and battery cables. Battery cables can be used with a 5/16" stud or traditional post. NOTE: It is recommended that a larger battery be used when mounting a winch to the Big Red. Made in the USA.

FITS MODEL	PART #
HONDA BIG RED ALL	0521-0771



BIG RED CAB HEATER > \$535.95

Fits all years and models. 12 volt, water operated cab heater. Quick and easy installation. Made in the USA.

FITS MODEL	PART #
HONDA BIG RED ALL	4510-0617



FULL FOLDING WINDSHIELD > \$8.95-\$322.95

Premium .177" thick clear polycarbonate shield. Centrally hinged for ventilation. Tool-less operation. Stainless steel rubber coated mount straps. Rubber seal helps keep elements out. Made in the USA.

FITS MODEL	OVERALL WIDTH	OVERALL HEIGHT	PART#
KAWASAKI MULE 3010 00-08	54"	35"	2317-0142 ¹
KAWASAKI MULE 4010 09-13	53"	30"	2317-0143 ¹
KAWASAKI TERYX 08-09	48"	26"	2317-0144 ¹
KAWASAKI TERYX 10-12	48"	26"	2317-0145 ¹
KAWASAKI TERYX 4 12	55"	20.25"	2317-0146
REPLACEMENT HOOD PUCKS (2 PIECE)	-	-	2317-0057

¹ NO HOOD ACCESS



MULTI - FULL



MULTI - LOWER

MULTI WINDSHIELD > \$348.95

Split windshield design allows the rider to configure the windshield. Three configurations (upper, lower and full). Mounts easily and can be quickly configured without tools. Trailerable to 65 mph. Constructed from optical grade acrylic. Comes with storage bag for storing one section at a time. Imported.

FITS MODEL	PART #
KAWASAKI TERYX 08-10	2317-0107



FULL WINDSHIELD > \$248.95

Premium .177" thick clear polycarbonate shield. Mounts to roll bar using stainless steel, rubber-coated mount straps. Rubber seal helps keep elements out. Made in the USA.

FITS MODEL	OVERALL WIDTH	OVERALL HEIGHT	PART#
KAWASAKI MULE 3010 00-08	54"	35.5"	2317-0153 ¹
KAWASAKI MULE 4010 09-13	53"	30.25"	2317-0154 ¹
KAWASAKI TERYX 08-09	48.75"	28"	2317-0155 ¹
KAWASAKI TERYX 4 10-13	49"	26.5"	2317-0156

¹ NO HOOD ACCESS



HALF WINDSHIELD > \$142.95

Premium .177" thick polycarbonate. Stainless steel rubber coated mounting clamps. Rubber seal helps keep elements out. Made in the USA.

FITS MODEL	OVERALL WIDTH	OVERALL HEIGHT	PART#
KAWASAKI MULE 610 07-13	48.5"	14.5"	2317-0132 ¹
KAWASAKI TERYX 08-09	48"	10"	2317-0133 ¹
KAWASAKI TERYX 10-13	48"	9.6"	2317-0134 ¹
KAWASAKI TERYX 4 12	55"	10"	2317-0135

¹ NO HOOD ACCESS



TERYX BACK PANEL > \$254.95

Constructed of .177" thick clear polycarbonate. Adds a finished look to your UTV and provides an effective barrier to keep debris from entering the cab. Made in the USA.

FITS MODEL	OVERALL WIDTH	OVERALL HEIGHT	PART#
KAWASAKI TERYX 08-10	55"	34"	0521-0869

PLOWS

WINCHES

UTV

RACKS

LUGGAGE

BODY

CONTROLS

ELECTRICAL

WHEELS & TIRES

SUSPENSION & DRIVE

ENGINE

NRA BY MOOSE

RIDER

TOWING

GARAGE

PROMO

M.U.D.



TERYX EXHAUST TIP > \$39.95

Made from CNC-billet aluminum. Angled exhaust port and machined gun barrel divots on the tip. Angle directs exhaust flow down and away from fenders and tailgates. Comes with mounting bolts and screen. Made in the USA.



FITS MODEL	PART #
TERYX 750 08-12	1861-0481



TERYX BED RAILS > \$114.95

Texture powder-coated and bolt on requiring no drilling. Made from 1" diameter tubing and 11 gauge steel. Sold as pairs. Made in the USA.

FITS MODEL	PART #
KAWASAKI TERYX 04-11	0521-0629



MULE BENCH SEAT COVER > \$104.95

Made from 500-denier Cordura®. Protects the seat from punctures and daily wear. Made in the USA.

FITS MODEL	PART #
MULE 2500/3000/4000	
BLACK	MUDKM-124
MOSSY OAK BREAK-UP®	MUDKM-126



MULE ROOF COVERS > \$81.95

Perfect for winter or rainy weather. Includes adhesive backed hook-and-loop closure for mounting to roll cage. Made in the USA.

FITS MODEL	PART #
MULE 2500/3000/4000	
BLACK (40 OZ. TONNEAU-TEX VINYL)	MUDKM-116



CAB ENCLOSURES > \$504.95-\$519.95

Perfect for winter/rainy weather. Zippered doors for fast entry; straps keep doors rolled up/open. Heavy acrylic windshield. Made in the USA.

FITS MODEL	PART #
MULE 610 SERIES - ALL YEARS (NOT SHOWN)	
BLACK (40 OZ. TONNEAU-TEX VINYL)	0521-0282
MOSSY OAK BREAK-UP® (500 DENIER CORDURA®)	0521-0283
MULE 3000 SERIES - ALL YEARS	
BLACK (40 OZ. TONNEAU-TEX VINYL)	MUDKM-104
MOSSY OAK BREAK-UP® (500 DENIER CORDURA®)	MUDKM-106
MULE 4000 SERIES 09-11 (NOT SHOWN)	
BLACK (40 OZ. TONNEAU-TEX VINYL)	0521-0820
MOSSY OAK BREAK-UP® (500 DENIER CORDURA®)	0521-0821
TERYX - ALL YEARS	
BLACK (40 OZ. TONNEAU-TEX VINYL)	0521-0633
MOSSY OAK BREAK-UP® (500 DENIER CORDURA®)	0521-0634



FULL FOLDING WINDSHIELD > \$8.95-\$322.95

Premium .177" thick clear polycarbonate shield. Centrally hinged for ventilation. Tool-less operation. Stainless steel rubber coated mount straps. Rubber seal helps keep elements out. Made in the USA.

FITS MODEL	OVERALL WIDTH	OVERALL HEIGHT	PART #
POLARIS RANGER THRU 00-08 (NOT SHOWN)	59"	33"	2317-0147
POLARIS RANGER 700/800 09-12	53"	31.5"	2317-0148
POLARIS RANGER 400/500 09-12 MIDSIZE (NOT SHOWN)	45.45"	29.25"	2317-0149
POLARIS RZR 800 08-12 / RZR 900 XP 11-12	40"	20.5"	2317-0150
REPLACEMENT HOOD PUCKS (2 PIECE)	-	-	2317-0057



RANGER MULTI WINDSHIELD > \$354.95

Split windshield design allows the rider to configure the windshield. Three configurations (upper, lower and full). Mounts easily and can be quickly configured without tools. Trailerable to 65 mph. Constructed from optical grade acrylic. Comes with storage bag for storing one section at a time. Imported.

FITS MODEL	PART #
POLARIS RANGER 700/800 09-12	2317-0105
POLARIS RANGER 400/500 09-12 (NOT SHOWN)	2317-0106



RZR MULTI WINDSHIELD > \$342.95

Split windshield design allows the rider to configure the windshield. Three configurations (upper, lower and full). Mounts easily and can be quickly configured without tools. Trailerable to 65 mph. Constructed from optical grade acrylic. Comes with storage bag for storing one section at a time. Imported.

FITS MODEL	PART #
POLARIS RZR 800 08-12 / RZR 900 XP 11-12	2317-0119



FULL WINDSHIELD > \$248.95

Premium .177" thick clear polycarbonate shield. Mounts to roll bar using stainless steel, rubber-coated mount straps. Rubber seal helps keep elements out. Made in the USA.

FITS MODEL	OVERALL WIDTH	OVERALL HEIGHT	PART#
POLARIS RANGER 700/800 09-12	53"	29"	2317-0157
POLARIS RANGER 400/500 9-12	47"	29.25"	2317-0158
POLARIS RZR 800 08-12 / RZR 900 XP 11-12	40"	25"	2317-0159



RANGER HALF WINDSHIELD > \$142.95

Premium .177" thick polycarbonate. Stainless steel rubber coated mounting clamps. Rubber seal helps keep elements out. Made in the USA.

FITS MODEL	OVERALL WIDTH	OVERALL HEIGHT	PART#
POLARIS RANGER 700/800 09-12	53"	13.5"	2317-0136



2317-0944



2317-0945

REAR DUST PANELS > \$89.95

Multiple straps allow the dust panel to work with most hardtops. Large vinyl window. Constructed from heavy-duty rip stop nylon. Easy installation and removal. Imported.

FITS MODEL	PART #
POLARIS RANGER 400/500 09-13 (MIDSIZE)	0521-0944
POLARIS RANGER 700/800 09-13 (FULL SIZE)	0521-0943
POLARIS RZR 800 08-13	0521-0945

RANGER SOFT TOPS WITH INTEGRATED REAR PANEL > \$139.95

Durable UV resistant, PVC coated denier nylon. Vehicle specific design for a great fit. Secures to windshields with adhesive backed hook and loop closures. Easily installs without tools and drilling. Uses Quickfit tightening system to create a super tight fit with no loose flaps. Rear panel can be rolled and strapped up for ventilation. Imported.

FITS MODEL	PART #
FULL SIZE POLARIS RANGER 09-13	0521-1043 ¹
MIDSIZE POLARIS RANGER 09-13	0521-1044

¹ NOT FOR 13 RANGER 900 XP.



PLOWS

WINCHES

UTV

RACKS

LUGGAGE

BODY

CONTROLS

ELECTRICAL

WHEELS & TIRES

SUSPENSION & DRIVE

ENGINE

NRA BY MOOSE

RIDER

TOWING

GARAGE

PROMO



RZR BACK PANEL > \$224.95

Constructed of .177" thick clear polycarbonate. Adds a finished look to your UTV and provides an effective barrier to keep debris from entering the cab. Made in the USA.

FITS MODEL	OVERALL WIDTH	OVERALL HEIGHT	PART#
POLARIS RZR 08-12	47.5"	29"	0521-0872



RANGER ROOF > \$297.95-\$319.95

Manufactured from durable, rotomolded LLDPE (linear low-density polyethylene). UV resistant, textured finish. Double wall construction provides extra rigidity and protection. Stainless steel mounting hardware. Made in the USA.

FITS MODEL	PART#
POLARIS RANGER 400/500 10-12 (MIDSIZE)	0521-0961
POLARIS RANGER 700/800 10-12 (FULLSIZE)	0521-0962



RANGER BACK PANEL > \$254.95

Constructed of .177" thick clear polycarbonate. Adds a finished look to your UTV and provides an effective barrier to keep debris from entering the cab. Made in the USA.

FITS MODEL	OVERALL WIDTH	OVERALL HEIGHT	PART#
POLARIS RANGER 08-12	58"	39.87"	0521-0871
POLARIS RANGER 400 10-12	52"	42"	0521-0908



RANGER 900 TWO-PIECE ROOF > \$192.95

Fits full-size Ranger 900 13. Two-piece design. Durable polyethylene with UV stabilizers. Molded water run-off area. Installed size: 63.5" W x 35" L x 5.25" H. Made in the USA.

FITS MODEL	PART#
POLARIS RANGER 900 13 (FULLSIZE)	0521-1046



RZR ROOF > \$112.95

One piece design manufactured from premium .200" thick plastic material that is durable and weather resistant. Comes with all mounting hardware. 34.5" W x 43" L x 6.5" H. Made in the USA.

FITS MODEL	PART#
POLARIS RZR ALL 08-12	0521-0864



RANGER 700/800 TWO-PIECE ROOF > \$192.95

Fits full-size Ranger 700/800 11-12. Two-piece design. Durable polyethylene with UV stabilizers. Molded water run-off area. Installed size: 62.5" W x 36" L x 3.75" H. Made in the USA.

FITS MODEL	PART#
POLARIS RANGER 700/800 10-12 (FULLSIZE)	0521-0994



RZR BED TOPPER > \$244.95

Fits all RZR 800 two and four passenger vehicles. Durable polyethylene with UV stabilizers. Not for 09-10 "S" models. Made in the USA.

FITS MODEL	PART#
POLARIS RZR 800 ALL	0521-0993



RANGER SADDLE BOX > \$88.95

Manufactured from durable, rotomolded LLDPE (linear low-density polyethylene). UV resistant, textured finish. Single wall body allows for maximum storage space. Double wall lid provides extra rigidity and protection. Provides 1,157 cubic inches of storage each (0.669 cubic feet / 5 gallons). Features a key-lockable latch for added security. Simply drop box posts into the existing bed holes. Can be removed and carried using the box's molded-in hand pockets. Fits all Polaris Ranger dump beds. Sold as each. Made in the USA.

FITS MODEL	PART#
POLARIS RANGER ALL	1512-0107

RANGER CROSSOVER BOX > \$276.95

Manufactured from durable, rotomolded LLDPE (linear low-density polyethylene). UV resistant, textured finish. Single wall body allows for maximum storage space. Double wall lid provides extra rigidity and protection. Provides 7,574 cubic inches of storage each (4.38 cubic feet / 32.8 gallons). Features a key-lockable latch for added security. Simply drop box posts into the existing bed holes. Can be removed and carried using the box's molded-in hand pockets. Fits all Polaris Ranger dump beds. Sold in pairs. Made in the USA.

FITS MODEL	PART#
POLARIS RANGER ALL	1512-0108

M.U.D.



RANGER 800 BED EXTENSION > \$308.95

Manufactured from durable, rotomolded LLDPE (linear low-density polyethylene). UV resistant, textured finish. Double wall construction provides extra rigidity and protection. Adds additional height of 17.125". Interlocking panels drop into the existing bed holes. No hardware needed. Made in the USA.

FITS MODEL	PART#
POLARIS RANGER 800 ALL	0521-0964



RANGER FRONT RECEIVER HITCHES > \$142.95-\$156.95

Accepts standard 2" trailer hitch type receiver. Mounts to the frame under the front differential. Made from 2.5" square tubing. Mounting hardware and hitch pin included. Powder coated for superior protection. Bolts-on, no drilling or cutting. Can be used with the Meyer Drive Pro UTV Plow System. Made in the USA.

FITS MODEL	PART #	FITS MODEL	PART #
RANGER 400 (MID SIZE) 10-13	4504-0087	RANGER 800 MIDSIZE 13	4504-0087
RANGER 500 4X4 05-08	4504-0086	RANGER CREW 08-09	4504-0086
RANGER 500 (FULL SIZE) 09-10	4504-0085	RANGER CREW 10-13	4504-0085
RANGER 500 (MID SIZE) 11-13	4504-0087	RANGER EV 10-13	4504-0087
RANGER XP 700 05-08	4504-0086	RANGER 900 XP 13	4504-0089
RANGER XP 800 10-13	4504-0085		



RZR PARKING BRAKE > \$129.95

Parking brake system makes shifting out of your park gear easier, especially on uneven surfaces. This prevents damage to the shift linkage and transmission. Engineered from the highest quality materials for a factory look and precision fit. Imported.

FITS MODEL	PART #
POLARIS RZR ALL 08-13	1704-0350

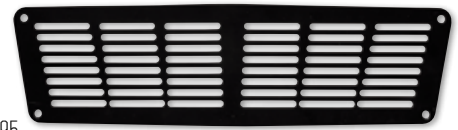

RZR RADIATOR BREATHER & GUARD > \$44.95

Powder coated guard bolts to the stock hood increasing air flow to the radiator. Includes mounting hardware and cut template. Unlike other breather guards on the market, ours has a slight horizontal bend in the center to follow the contour of the Polaris RZR hood. Made in the USA.

FITS MODEL	PART #
POLARIS RZR 800 08-11	1904-0062



CLOSED



OPEN



RANGER FULLSIZE DOORS WITH INTEGRATED REAR PANEL > \$699.95

Fits full size Polaris Rangers 09-13 (except for the 13 Ranger XP 900). Sturdy 3/4" tubular steel frame and door latch. Durable UV resistant, PVC coated heavyweight nylon covers. Entire doors come off in seconds, no tools required. Upper door covers are easily removable for ventilation. Easy installation with Quickfit strapping system; no drilling required which doesn't void any warranties. Extra window on the bottom half of the doors for added visibility. Tight all around seal resists water and wind intrusion into the cab. Rear window panel provides weather protection and great rear visibility. Shown with 0521-0994 roof. Imported.

FITS MODEL	PART#
FULL SIZE POLARIS RANGER 09-13	0521-1042
MID SIZE POLARIS RANGER 12-13	0521-1058

¹ NOT FOR 13 RANGER 900 XP.



CAB ENCLOSURE > \$504.95-\$519.95

Perfect for winter or rainy weather. Zippered doors for fast entry; straps keep doors rolled up and open. Heavy acrylic windshield. Made in the USA.

FITS MODEL	PART #
POLARIS RANGER 02-08	
BLACK (40 OZ. TONNEAU-TEX VINYL)	MUDPR-100
MOSSY OAK BREAK-UP® (500 DENIER CORDURA®)	MUDPR-102
POLARIS RANGER 09-10 (NOT SHOWN)	
MOSSY OAK BREAK-UP® (500 DENIER CORDURA®)	0521-0823



CAB ENCLOSURE > \$504.95-\$519.95

Perfect for winter or rainy weather. Zippered doors for fast entry; straps keep doors rolled up and open. Heavy acrylic windshield. Made in the USA.

FITS MODEL	PART #
POLARIS RZR ALL	
BLACK (40 OZ. TONNEAU-TEX VINYL)	0521-0569
MOSSY OAK BREAK-UP® (500 DENIER CORDURA®)	0521-0570



RANGER BENCH SEAT COVER > \$104.95-\$107.95

Made from 500-denier Cordura®. Protects the seat from punctures and daily wear. Comes with headrests. Made in the USA.

FITS MODEL	PART #
POLARIS RANGER 02-08	
BLACK	MUDPR-112
MOSSY OAK BREAK-UP®	MUDPR-114
POLARIS RANGER 09-11	
BLACK	0821-0995
MOSSY OAK BREAK-UP®	0821-0996



ROOF CAP > \$81.95-\$83.95

Perfect for winter or rainy weather. Includes adhesive backed hook-and-loop closure for mounting to roll cage. Made in the USA.

FITS MODEL	PART #
POLARIS RANGER 02-08	
BLACK (40 OZ. TONNEAU-TEX VINYL)	MUDPR-108
MOSSY OAK BREAK-UP® (500 DENIER CORDURA®)	MUDPR-110
POLARIS RANGER 09-10	
BLACK (40 OZ. TONNEAU-TEX VINYL)	0521-0826
MOSSY OAK BREAK-UP® (500 DENIER CORDURA®)	0521-0827
POLARIS RZR ALL	
MOSSY OAK BREAK-UP® (500 DENIER CORDURA®)	0521-0572



RHINO FULL WINDSHIELD > \$248.95

No holes to drill. Mounts with six composite clamps. Top and bottom supports to add rigidity. Includes all hardware. Works with factory roof or our roof. Made in the USA.

FITS MODEL	OVERALL WIDTH	OVERALL HEIGHT	PART#
YAMAHA RHINO (ALL MODELS) 04-11	50"	28.5"	2317-0160



RHINO HALF WINDSHIELD > \$142.95

Premium .177" thick polycarbonate. Stainless steel rubber coated mounting clamps. Made in the USA.

FITS MODEL	OVERALL WIDTH	OVERALL HEIGHT	PART#
YAMAHA RHINO (ALL MODELS) 04-11	50"	12.25"	2317-0137
YAMAHA RHINO (ALL MODELS) 12-13	50"	11"	2317-0161



MULTI - FULL
2317-0104



MULTI - LOWER
2317-0104

RHINO MULTI WINDSHIELD > \$348.95

Split windshield design allows the rider to configure the windshield. Three configurations (upper, lower and full). Mounts easily and can be quickly configured without tools. Trailerable to 65 mph. Constructed from optical grade acrylic. Comes with storage bag for storing one section at a time. Imported.

FITS MODEL	PART #
YAMAHA RHINO (ALL MODELS) 04-13	2317-0104



RHINO FULL FOLDING WINDSHIELD > \$8.95-\$322.95

Premium .177" thick clear polycarbonate shield. Centrally hinged for ventilation. Tool-less operation. Stainless steel rubber coated mount straps. Made in the USA.

FITS MODEL	OVERALL WIDTH	OVERALL HEIGHT	PART#
YAMAHA RHINO (ALL MODELS) 04-11	50"	26.5"	2317-0151
YAMAHA RHINO (ALL MODELS) 12-13	50"	29"	2317-0152
REPLACEMENT HOOD PUCKS (2 PIECE)	-	-	2317-0057



RHINO BACK PANEL > \$254.95

Constructed of .177" thick clear polycarbonate. Adds a finished look to your UTV and provides an effective barrier to keep debris from entering the cab. Made in the USA.

FITS MODEL	OVERALL WIDTH	OVERALL HEIGHT	PART#
YAMAHA RHINO ALL MODELS 04-10	51"	40"	0521-0870



RHINO SOFT TOP WITH INTEGRATED REAR PANEL > \$139.95
 Durable UV resistant, PVC coated denier nylon. Vehicle specific design for a great fit. Secures to windshields with adhesive backed hook and loop closures. Easily installs without tools and drilling. Uses Quickfit tightening system to create a super tight fit with no loose flaps. Rear panel can be rolled and strapped up for ventilation. Imported.

FITS MODEL	PART #
YAMAHA RHINO ALL	0521-1045



RHINO BED RAILS > \$114.95
 Texture powder coated bed rails bolt on requiring no drilling. Made from 1" diameter tubing and 11 ga. steel. Fits all year and models of Rhino. Sold as pairs. Made in the USA.

FITS MODEL	PART #
YAMAHA RHINO ALL	0521-0606



RHINO FRONT & REAR FENDER FLARES > \$209.95
 Durable double wall L.L.D.P.E. construction. Easily mounts to fenders with supplied stainless steel hardware. Designed to minimize flying debris from entering the passenger compartment while adding to the rugged style of your Rhino. Sold as set of four. Made in the USA.

FITS MODEL	PART #
YAMAHA RHINO 04-11	1420-0047

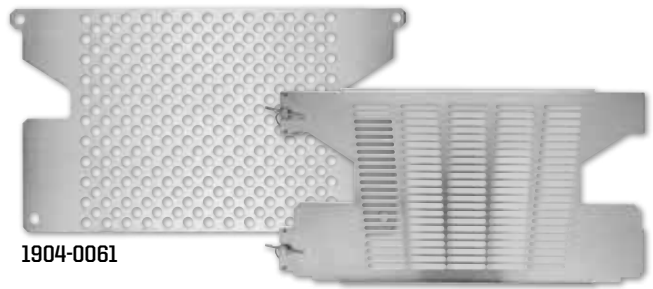

RHINO RADIATOR GUARDS > \$55.95-\$69.95
 Made from 5052 aircraft grade aluminum which protects your expensive radiator from sticks and debris. Rhino radiator guard mounts in front of the radiator. The quick connect guard attaches without any tools. Quick release version allows you to remove guard for radiator access. Fits all years and models of Yamaha Rhino. Made in the USA.

FITS MODEL	PART #
YAMAHA RHINO QUICK DISCONNECT RADIATOR GUARDS ALUMINIUM	1904-0058

FITS MODEL	PART #
YAMAHA RHINO NON-QUICK DISCONNECT RADIATOR GUARDS ALUMINIUM	1904-0061

RHINO BATTERY BOX > \$119.95
 Battery tray allows you to upgrade to a high powered battery or add an additional battery to your Rhino. Attaches to frame under your hood (to the right of your stock battery box). Powder coated for superior protection. 9 7/8"L x 7 1/8"W x 6 1/2"H. Includes mounting hardware. Made in the USA.

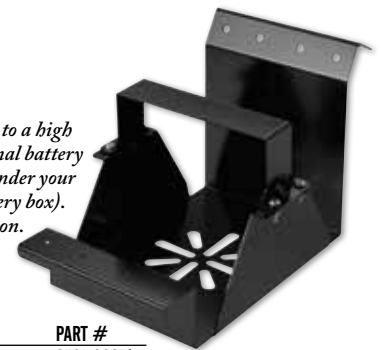

FITS MODEL	PART #
YAMAHA RHINO ALL	0521-0607 ¹

¹ WILL NOT FIT THE '08 700EFI

RHINO EXHAUST TIP > \$39.95-\$54.95
 Made from CNC-billet aluminum. Angled exhaust port and machined gun barrel divots on the tip. Angle directs exhaust flow down and away from fenders and tailgates. Comes with mounting bolts and screen. Made in the USA.



FITS MODEL	PART #
YAMAHA RHINO 450/650 04-09	1861-0374
YAMAHA RHINO 660 04-07	1861-0374
YAMAHA RHINO 700 08-12	1861-0485

PLOWS

WINCHES

UTV

RACKS

LUGGAGE

BODY

CONTROLS

ELECTRICAL

WHEELS & TIRES

SUSPENSION & DRIVE

ENGINE

NRA BY MOOSE

RIDER

TOWING

GARAGE

PROMO

M.U.D.





UTV REAR TUBE BUMPER > \$142.95

2 1/2" powder coated round steel tube. Great for rear protection. Allows for opening the tailgate when installed. Made in the USA.

FITS MODEL	BUMPER WIDTH	PART #
YAMAHA RHINO 450/660/700 06-11	48"	0530-0418



RHINO CAB ENCLOSURE > \$519.95

Perfect for winter or rainy weather. Made from material with automotive grade clear, flexible acrylic windshield, doors and back window. Doors are completely removable and have full-length double zippers. Doors can also be rolled up and fastened. Made in the USA.

FITS MODEL	PART #
YAMAHA RHINO CAB ENCLOSURE 04-11	
BLACK (40 OZ. TONNEAU-TEX VINYL)	4510-0001
MOSSY OAK BREAK-UP® (500 DENIER CORDURA®)	4510-0002
CAB ENCLOSURE FOR USE W/ OEM DOORS 04-11	
BLACK (40 OZ. TONNEAU-TEX VINYL)	0521-0669
MOSSY OAK BREAK-UP® (500 DENIER CORDURA®)	0521-0670

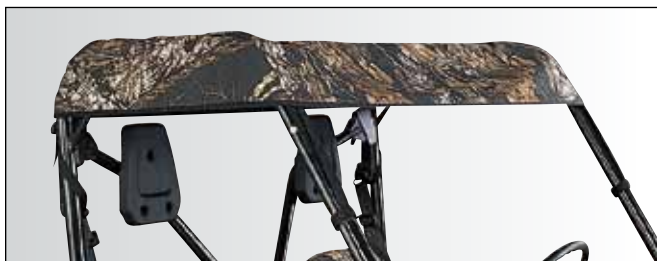

RHINO ROOF CAP > \$81.95

Perfect for winter or rainy weather. Fastens to cage with adhesive backed hook-and-loop closures and heavy web straps. Made in the USA.

FITS MODEL	PART #
YAMAHA RHINO 04-12	
BLACK (40 OZ. TONNEAU-TEX VINYL)	4510-0005
MOSSY OAK BREAK-UP® (500 DENIER CORDURA®)	4510-0006



RHINO NEOPRENE BUCKET SEAT COVERS > \$129.95

Neoprene seat covers are made of 3.0mm black neoprene insert which provides comfort and a barrier between rider and seat. Conforms to the seat for a tight custom fit that protects the seat from damage. Heavy elastic around edge of seat cover makes for easy installation without the need for tools. Drain holes are installed in seat bottom to allow liquids to escape. Includes: one pair of seat covers and headrest covers. Made in the USA.

FITS MODEL	PART #
YAMAHA RHINO 04-12	
BLACK	0821-0710
MOSSY OAK BREAK-UP®	0821-0711



RHINO BUCKET SEAT COVERS > \$104.95

Made from 500-denier waterproof Cordura®. Elastic outer edge attaches covers to seat bottom and back. Includes: one pair of seat covers and headrest covers. Made in the USA.

FITS MODEL	PART #
YAMAHA RHINO 04-12	
MOSSY OAK BREAK-UP®	4510-0008

PLOWS

WINCHES

UTV

RACKS

LUGGAGE

BODY

CONTROLS

ELECTRICAL

WHEELS & TIRES

SUSPENSION & DRIVE

ENGINE

NRA BY MOOSE

RIDER

TOWING

GARAGE

PROMO

M.U.D.





PROMO	GARAGE	TOWING	RIDER	NRA BY MOOSE	ENGINE	SUSPENSION & DRIVE	WHEELS & TIRES	ELECTRICAL	CONTROLS	BODY	LUGGAGE	RACKS	UTV	WINCHES	PLOWS
-------	--------	--------	-------	--------------	--------	--------------------	----------------	------------	----------	------	---------	-------	-----	---------	-------



W/ ADD-ON



EXPEDITION UTV GUN SCABBARD > \$38.95-\$78.95

Attaches quickly to the rear roll bar of any UTV. Constructed with weatherproof heavy gauge tarpaulin and high-denier PVC backed polyester. Lined with 1/2" of protective closed cell foam and convenient roll up openings, allows quick access to your weapon from either side of the vehicle. Two large exterior storage pockets and a center pocket sized to fit all standard ammo boxes, providing plenty of room for your shooting accessories. Dimensions: Overall 54.5" L x 11.5" H. 2-front pockets 17" L x 9.25" H x 2" D. 1-center pocket 6" L x 3.75" H x 1.5 D. Imported.

DESCRIPTION	PART #
EXPEDITION UTV GUN SCABBARD	
BLACK	3518-0039
MOSSY OAK BREAK-UP®	3518-0040
EXPEDITION UTV GUN SCABBARD ADD-ON	
BLACK	3518-0041
MOSSY OAK BREAK-UP®	3518-0042



UTV ROLL CAGE GUN RACK > \$198.95

Transport two firearms safely, securely and out of the way. Mounts snugly at the back of UTV's with cab frames measuring 50" to 64" wide. Attaches to the UTV frame and adjusts to fit all popular brands. Can be installed, or removed in seconds. Made from aircraft aluminum and finished with tough, powder coated paint for years of durability. Guns not included. Made in the USA.

DESCRIPTION	PART #
UTV ROLL CAGE GUN RACK	3518-0018



UTV BOW CARRIER > \$198.95

The most practical and space-saving method possible to safely transport a bow on a UTV. Mounts on a unique bracket that attaches to all UTV's with cab frames measuring 50" to 64" wide. Tension loaded holding cradles grip the limbs of any compound or recurve bow firmly and totally prevent any other part of the bow from touching anything. Bow not included. Made in the USA.

DESCRIPTION	PART #
UTV BOW CARRIER	3518-0061

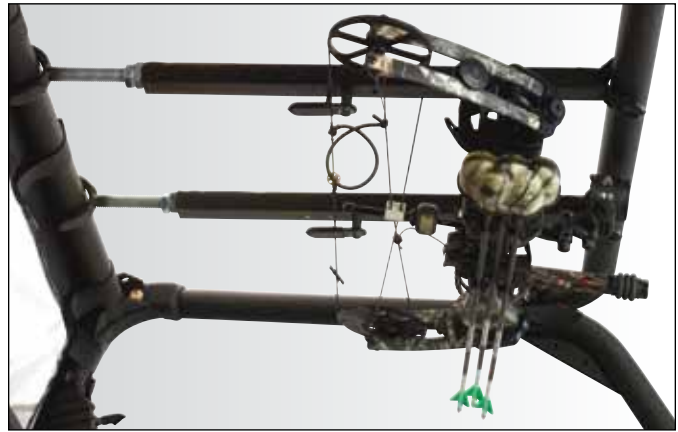

QUICKDRAW OVERHEAD BOW RACK > \$109.95

Perfect way to transport a bow on a utility vehicle. Holds your bow securely in the inside roof area of the UTV. Has two soft, cushioned cradles that prevent any disturbance to the bow's settings. Unique mounting system that installs in just minutes without any drilling or bolting. Positioned high and forward to allow the quiver to stay installed---ready for action! Fits Polaris Ranger 500, Polaris Ranger 800, Kubota RTV 500, Kawasaki Mule 610, Kawasaki Mule 4010 Honda Big Red. Bow not included. Made in the USA.

DESCRIPTION	PART #
QUICKDRAW OVERHEAD BOW RACK	3518-0067



UTV ENTRY ASSIST HANDLES > \$19.95

Entry assist handles attach to all utility vehicles with up to 4" roll bars. Assists in entry and exit of your utility vehicle. Sold in pairs. Imported.

DESCRIPTION	PART #
UTV ENTRY ASSIST HANDLES	4510-0051



UTV FIRE EXTINGUISHER HOLDER > \$19.95

Thick padding with twin straps fastens to roll cage of UTV. Drawstring top with cord lock secures fire extinguisher in place for mounting in any direction. Also fastens to tubular racks on ATV's. For use with most household or shop fire extinguishers. Fire extinguisher not included. Imported.

DESCRIPTION	PART #
BLACK	4050-0025
MOSSY OAK BREAK-UP®	4050-0026



UTV ROLL BAR 6-PK COOLER > \$19.95

Thick padding with twin straps fastens to roll cage of UTV. Also can fasten to tubular racks on ATV's. Made to hold six 12 oz. cans. Imported.

DESCRIPTION	PART #
BLACK	3511-0006
MOSSY OAK BREAK-UP®	3511-0007



- PLOWS
- WINCHES
- UTV**
- RACKS
- LUGGAGE
- BODY
- CONTROLS
- ELECTRICAL
- WHEELS & TIRES
- SUSPENSION & DRIVE
- ENGINE
- NRA BY MOOSE
- RIDER
- TOWING
- GARAGE
- PROMO



INSIDE/OUTSIDE STYLE



AUTO STYLE

UTV INSIDE/OUTSIDE MIRROR > \$19.95-\$21.95
 Roll bar mounted rear view mirror for all models of UTV's. Can be mounted inside or outside of cab with a simple clamp. Imported.

UTV REAR VIEW MIRROR - AUTO STYLE > \$23.95
 Large viewing surface. Adjustable viewing angles. Automotive styling. High impact plastic housing. Cast alloy arm. Mounts to 1.75" diameter rollbar. Imported.

FITS MODEL	PART #
UTV INSIDE/OUTSIDE MIRROR	
ARCTIC CAT PROWLER (SQUARE ROPS)	0640-0518
ARCTIC CAT PROWLER (ROUND ROPS) (1.75")	0640-0386
CAN AM COMMANDER (2" W/ SHIM)	0640-0582
JOHN DEERE GATOR HPX/XUV (1.75")	0640-0386
KAWASAKI MULE 600 (2" W/ SHIM) 08-10	0640-0582
KAWASAKI MULE 3000 (1.75")	0640-0386
KAWASAKI MULE 4000 (2" W/ SHIM) 08-10	0640-0582
KAWASAKI TERYX (2" W/SHIM) 08-10	0640-0582
KUBOTA RTV900, RTV1140 (2" W/ SHIM)	0640-0582
POLARIS RANGER & RZR'S (1.75")	0640-0386
YAMAHA RHINO (1.75")	0640-0386

FITS MODEL	PART #
UTV REAR VIEW MIRRORS - AUTO STYLE	
CAN AM COMMANDER (2" CLAMP WITH SHIM)	0640-0581
JOHN DEERE GATOR HPX & XUV (1.75" CLAMP)	0640-0517
KAWASAKI MULE 600 (2" CLAMP WITH SHIM)	0640-0581
KAWASAKI TERYX 750 (2" CLAMP WITH SHIM)	0640-0581
KAWASAKI MULE 3000 (1.75" CLAMP)	0640-0517
KAWASAKI MULE 4000 (2" CLAMP WITH SHIM)	0640-0581
KUBOTA RTV900, RTV1140 (2" CLAMP WITH SHIM)	0640-0581
POLARIS RANGERS (1.75" CLAMP)	0640-0517
POLARIS RZR (1.75" CLAMP)	0640-0517



BREAKAWAY FEATURE

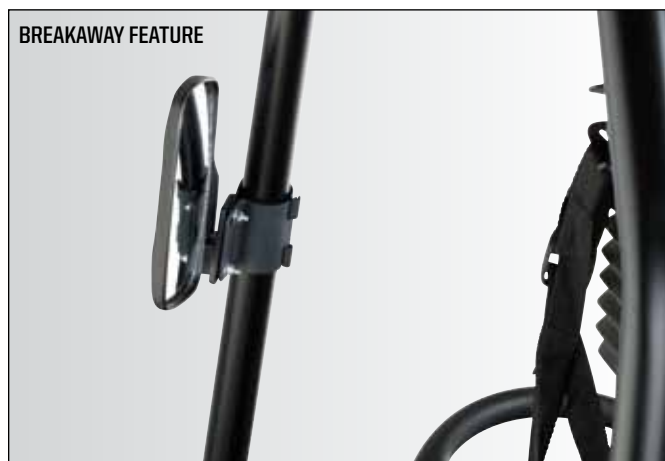

UTV MIRROR > \$54.95
 Flip back breakaway feature prevents damage on impact. Shatter resistant, tempered safety glass and high impact ABS housing. Convex mirror for wider viewing angles and image stability. 1.75" steel bar clamp for maximum strength and durability. Tension adjuster keeps mirror swing stiff - no floppy mirrors. Fits all Polaris UTV's, Yamaha Rhino, Kawasaki Mule 600/3000, John Deere Gator HPX & XUV'S. Sold in pairs. Imported.

DESCRIPTION	PART #
UTV MIRROR FOR 1.75" ROLLBARS	0640-0580



WIDE ANGLE UTV REARVIEW MIRROR > \$39.95
 Fits full size Polaris Rangers (except for the 2013 Ranger XP900), Mid size Polaris Rangers, All Polaris RZR's, John Deere Gators, Bad Boy MTV's, Kawasaki Mule 3000 and Bobcat UTV's. Steel 1.75" clamp minimizes vibration. Double ball joints provide a huge range of adjustability. Simple one screw setup. Massive viewing surface with convex mirror increases visibility. Imported.

DESCRIPTION	PART #
UTV MIRROR FOR 1.75" ROLLBARS	0640-0735



UTV CAB HEATER > \$79.95
 Stay warm with a 12V/300 watt heater for your UTV. Features a 3 position switch from heat to fan only. Top knob rotates to adjust fan speed. Positive cable is fused. Adjustable fan speeds. Swivel stand allows airflow to be re-directed. Unit draws 19 amps. Not to be used as a defroster. Imported.

DESCRIPTION	PART #
UTV CAB HEATER	4510-0323

UTV CAB HEATERS > \$482.95-\$535.95

12 volt universal cab heater kit for UTV's with 1" and 3/4" radiator hoses. Quick and easy installation. Typically installs in about an hour. Water operated. Made in the USA.

FITS MODEL	PART #
CAB HEATER	
ARCTIC CAT	PART #
PROWLER 550 09	4510-0545 ¹
PROWLER 650 06-09	4510-0545 ¹
PROWLER 700 08-09	4510-0545 ¹
PROWLER 1000 09	4510-0545 ¹
BOBCAT	
2200 ALL	4510-0545 ¹
2200 ALL	4510-0546 ²
2300 ALL	4510-0545 ¹
2300 ALL	4510-0546 ²
5600 ALL	4510-0545 ¹
5600 ALL	4510-0546 ²
CLUB CAR	
XRT 1550 DIESEL ALL	4510-0545 ¹
XRT 1550 DIESEL ALL	4510-0546 ²
CUB CADET	
VOLUNTEER EFI ALL	4510-0545 ¹
VOLUNTEER EFI ALL	4510-0546 ²
HONDA	
BIG RED 11-12	4510-0617
JOHN DEERE	
PRO GATOR 2020/A/H.D. 03-08	4510-0545
PRO GATOR 2030/A/H.D./DIESEL 03-08	4510-0545
GATOR 6X4 03-11 (ALL)	4510-0545
GATOR HPX/4X4 DIESEL 04-11	4510-0545
DIESEL GATOR/TRAIL GATOR 6X4 03-07	4510-0545
WORKSITE GATOR 03-04	4510-0545
TRAIL GATOR HPX 4X4 04-06	4510-0545
GATOR XUV 620I/625I 4X4 07-11 (ALL)	4510-0545
GATOR XUV 825I/850D/855D 4X4 07-11 (ALL)	4510-0545
KAWASAKI	
MULE 1000 ALL	4510-0545 ¹
MULE 1000 ALL	4510-0546 ²
MULE 2500 ALL	4510-0545 ¹
MULE 2500 ALL	4510-0546 ²
MULE 2510 ALL	4510-0545 ¹
MULE 2510 ALL	4510-0546 ²
MULE 2520 ALL	4510-0545 ¹
MULE 2520 ALL	4510-0546 ²
MULE 3000 ALL	4510-0545 ¹
MULE 3000 ALL	4510-0546 ²
MULE 3010 ALL	4510-0545 ¹

FITS MODEL	PART #
CAB HEATER (CON'T)	
KAWASAKI (CON'T)	
MULE 3010 ALL	4510-0546 ²
MULE 3020 ALL	4510-0545 ¹
MULE 3020 ALL	4510-0546 ²
MULE 4000 ALL	4510-0545 ¹
MULE 4000 ALL	4510-0546 ²
MULE 4010 ALL	4510-0545 ¹
MULE 4010 ALL	4510-0546 ²
TERYX 750 08-11	4510-0546 ²
KUBOTA	
RTV500 ALL	4510-0545 ¹
RTV500 ALL	4510-0546 ²
RTV900 ALL	4510-0546 ²
RTV900 ALL	4510-0545 ¹
RTV1100 ALL	4510-0545 ¹
RTV1100 ALL	4510-0546 ²
RTV1140 ALL	4510-0545 ¹
RTV1140 ALL	4510-0546 ²
POLARIS	
RANGER 2X4 05	4510-0545 ¹
RANGER 4X4 05	4510-0545 ¹
RANGER 500 2X4 06-09	4510-0545 ¹
RANGER 500 4X4 06-09	4510-0545 ¹
RANGER 6X6 05	4510-0545 ¹
RANGER 700 4X4 07-09	4510-0545 ¹
RANGER 700 4X4 CREW 08-09	4510-0545 ¹
RANGER 800XP 10-12 (STANDARD)	4510-0634
RANGER 800XP 10-12 (DELUXE)	4510-0641
RANGER 900 13	4510-0642
RANGER RZR 800 08-10	4510-0547 ³
RANGER RZR S 800 09-10	4510-0547 ³
RANGER RZR 900 XP 12	4510-0547 ³
YAMAHA	
RHINO 450 04-09	4510-0545 ¹
RHINO 660 04-07	4510-0545 ¹
RHINO 700 08-09	4510-0545 ¹

¹ 4510-0545 - UNITS W/ 1" RADIATOR HOSES.

² 4510-0546 - UNITS W/ 3/4" RADIATOR HOSES.

³ 16,000 BTU 3 SPEED FAN. BOLT IN CAB HEATER WITH DEFROST WITH MOUNTING HARDWARE. WILL NOT WORK WITH FACTORY POWER STEERING.

PLOWS

WINCHES

UTV

RACKS

LUGGAGE

BODY

CONTROLS

ELECTRICAL

WHEELS & TIRES

SUSPENSION & DRIVE

ENGINE

NRA BY MOOSE

RIDER

TOWING

GARAGE

PROMO



YAMAHA RHINO/KAWASAKI TERYX ROOF > \$139.95

Durable polyethylene w/ UV stabilizers. Extremely durable in cold weather. Molded in cargo tray allows for extra storage with bungees or cargo net. Fits Rhino and Teryx models. Measures 59" W x 30" L x 5" H. 20 lb. weight limit. Must remove for trailering. Made in the USA.

FITS MODEL	PART #
YAMAHA RHINO Q4-12	0521-0867
KAWASAKI TERYX 08-12	0521-0867



UTV DIAMOND PLATE BED TRUNK > \$339.95

Heavy-duty diamond plate, aluminum construction. Hemmed lid with adjustable lid striker and weatherproof seal. Stainless steel, lockable paddle handle. Gas strut lifts lid for easy access. Rear 34.5" x front 20.75" x 9 7/8" W x 15.25" H. Made in the USA.

DESCRIPTION	PART #
UTV DIAMOND PLATE BED TRUNK	1512-0138



UNIVERSAL 2-PIECE ROOF > \$192.95

Durable polyethylene w/ UV stabilizers. Molded water run-off area. Molded in cargo tray allows for extra storage. Fits many vehicles including Rangers and Honda Big Red. Measures 60" W x 43.5" L x 5.5" H. 20 lb. weight limit. Made in the USA.

DESCRIPTION	PART #
UNIVERSAL 2-PIECE ROOF	0521-0868



UTV BED TRUNK > \$349.95

Keep your gear secure and dry. Prevents items from bouncing around in UTV bed. Easy installation. Universal fit for any UTV bed. 48.25" L x 18.25" W x 18" D. Imported.

DESCRIPTION	PART #
UTV BED TRUNK	1512-0100



FOUR PASSENGER 2-PIECE UTV ROOF > \$362.95-\$499.95

Fits Kawasaki Trans and Polaris Crew Cab. Made from black ABS. All mounting hardware and instructions included. Measures 59.5" W x 59.5" L x 3" H. 20 lb. weight limit. Made in the USA.

FITS MODEL	PART #
KAWASAKI MULE TRANS 4 08-10	0521-0880
POLARIS RANGER CREW CAB THRU 09	0521-0880
POLARIS RANGER CREW CAB 10-12	0521-0955



UTV FRONT RACK > \$99.95-\$117.95

3/4" powder coated round tubing. Great for hauling an extra load. The easy release attachment allows the rack to pivot forward without having to unbolt or remove the entire rack system. This feature allows easy access to the units hood as well as proper clearance to open the hood. 100 lb. weight capacity. Made in the USA.

DESCRIPTION	PART #
UNIVERSAL FRONT RACK	1512-0037

MOUNTING KITS		MOUNTING KITS	
KAWASAKI TERYX 08-09	1512-0066	POLARIS RANGER 700/800 05-08	1512-0039
POLARIS RANGER 700/800 09-11	1512-0080	YAMAHA RHINO 04-12	1512-0038



OZARK UTV COVER > \$97.95

Made from strong, urethane coated black nylon. Water-resistant. Made to fit all utility vehicles. Measures 120" L x 65" W x 76" H. Imported.

DESCRIPTION	PART #
UTV COVER	4002-0058

PLOWS

WINCHES

UTV

RACKS

LUGGAGE

BODY

CONTROLS

ELECTRICAL

WHEELS & TIRES

SUSPENSION & DRIVE

ENGINE

NRA BY MOOSE

RIDER

TOWING

GARAGE

PROMO





PROMO
GARAGE
TOWING
RIDER
NRA BY MOOSE
ENGINE
SUSPENSION & DRIVE
WHEELS & TIRES
ELECTRICAL
CONTROLS
BODY
LUGGAGE
RACKS
UTV
WINCHES
PLOWS



TAILGATE CLOSED



TAILGATE OPEN

DROP RACK > \$228.95

Brand new design has a univesal fit for all ATV's. Strong yet light formed floor. Square steel framework wrapped in patterned sheet metal is tough and good looking. Black textured, powder-coated finish. Holds three five gallon buckets with room to spare. Incorporates an easy to use tailgate to make loading/unloading easier. Simple j-hook installation hardware works on most steel and plastic OEM racks. Install or remove in seconds without any tools. 41" W x 14" L x 11.56" D dimensions. Long back drop rack (1512-0082) mounting surface is 41" W x 12" L. Short back drop rack (1512-0081) mounting surface is 41" W x 9.75" L. Some assembly required. Made in the USA.

FITS MODEL	PART #
DROP RACK	
ARCTIC CAT	
250 2X4 99-01	1512-0082
300 2X4/4X4 96-05	1512-0082
375 4X4 AUTOMATIC 02	1512-0082
400 4X4 (ALL EXCEPT TRV/TBX) 00-08	1512-0082
450 4X4 11	1512-0082
454 2X4/4X4 BEARCAT 96-98	1512-0082
500 4X4 (ALL EXCEPT TRV/TBX) 00-09	1512-0082
550 4X4 09-11	1512-0082
650 4X4 V2/H1 04-08 (WILL NOT FIT LE)	1512-0082
700 4X4 (INCLUDING MUD PRO) 08-12	1512-0082
CAN-AM	
OUTLANDER 800 06-12	1512-0082
OUTLANDER 800 MAX 11	1512-0082
OUTLANDER 650 06-11	1512-0082
OUTLANDER 650 MAX 11	1512-0082
OUTLANDER 500 11	1512-0082
TRAXTER MAX 500 4X4 04	1512-0082
TRAXTER 500 03	1512-0082
TRAXTER XT/XL 500 03	1512-0082
QUEST XT650 4X4 02-03	1512-0082
HONDA	
TRX250 RECON 97-13	1512-0082
TRX300 2X4/4X4 93-00	1512-0082
TRX350/S RANCHER 2X4/4X4 01-05	1512-0082
TRX400 FOREMAN 4X4 95-01	1512-0082
TRX400 RANCHER 4X4 04-06 (ALL)	1512-0082
TRX420 RANCHER 4X4 07-13	1512-0082
TRX450S/ES 4X4 98-03	1512-0082
TRX500 RUBICON 01-04	1512-0082
TRX500 FOREMAN/RUBICON 05-13	1512-0081
TRX650 RINCON 03-06	1512-0081
TRX680 RINCON 07-13	1512-0081
KAWASAKI	
KLF220 BAYOU 88-00	1512-0081
KLF300 BAYOU 2X4/4X4 89-01	1512-0082
KVF300 PRAIRIE 2X4/4X4 99-02	1512-0081
KVF360 PRAIRIE 2X4/4X4 02-03	1512-0082
KVF360 PRAIRIE 4X4 04-05	1512-0081
KVF360 PRAIRIE 4X4 08-11	1512-0082
KVF400 PRAIRIE 2X4 97-99/4X4 97-98	1512-0081
KVF400 PRAIRIE 4X4 99-02	1512-0081
KVF650 PRAIRIE 4X4 02-03	1512-0082

FITS MODEL	PART #
DROP RACK (CON'T)	
KAWASAKI (CON'T)	
KVF650 BRUTE FORCE 4X4 05-09	1512-0081
KVF650 BRUTE FORCE IND. SUSP. 11-13	1512-0082
KVF700 PRAIRIE 4X4 04-06	1512-0081
KVF750 BRUTE FORCE 4X4 05-13	1512-0082
POLARIS	
ALL PLASTIC REAR RACK MODELS 96-12	1512-0081 ¹
250 XPLORER 4X4 00-01	1512-0081
300 2X4/4X4 94-95	1512-0081
300 XPLORER 4X4 96-99	1512-0081
300 XPRESS 98-99	1512-0081
325 MAGNUM 4X4 00-01	1512-0081
335 SPORTSMAN 99-01	1512-0081
350L 2X4/4X4 92-93	1512-0081
400 SPORTSMAN 01	1512-0081
400 XPLORER 4X4 95-01	1512-0081
400L 2X4/4X4 94-95	1512-0081
425 MAGNUM 2X4/4X4 95-98	1512-0081
455 DIESEL 99-00	1512-0081
500 MAGNUM 99-00	1512-0081
SUZUKI	
LTF250 QUAD RUNNER 99-01	1512-0082
LTF250 OZARK 02-04	1512-0082
LTF300 KING QUAD 99-02	1512-0082
LT400 EIGER 02-07	1512-0082
LT400 KING QUAD 08-13	1512-0081
LT450 KING QUAD 07-09	1512-0081
LT-F500F QUAD RUNNER 4X4 98-02	1512-0082
LT-A500 QUAD MASTER 4Z4 00-01	1512-0082
LT500 VINSON 02-07	1512-0081
LT500 KING QUAD 09-13	1512-0082
LT700 KING QUAD 05-07	1512-0081
LT700 TWIN PEAKS 04-05	1512-0081
LT750 KING QUAD 08-13	1512-0082
YAMAHA	
YFM250 BEARTRACKER 2X4 99-02	1512-0082
YFM350FW BIG BEAR 4X4 87-96	1512-0082
YFM350 BIG BEAR 2X4/4X4 97-99	1512-0082
YFM350 BRUIN AUTO 4X4 04-05	1512-0082
YFM350 GRIZZLY 07-11	1512-0082
YFM400 BIG BEAR 4X4 00-11	1512-0082
YFM400 KODIAK 4X4 96-05	1512-0082
YFM450 KODIAK ULTRAMATIC 4X4 03-06	1512-0082
YFM450 GRIZZLY 07-13	1512-0082
YFM550 GRIZZLY 09-13	1512-0082
YFM600 GRIZZLY 98-01	1512-0082
YFM660 GRIZZLY 02-08	1512-0082
YFM700 GRIZZLY 07-13	1512-0081

¹ WILL NOT FIT 11-13 SPORTSMAN 500/800
NOTE: NEVER EXCEED MANUFACTURERS RECOMMENDED WEIGHT CAPACITY LIMITS.



FRONT



REAR

1512-0076 straight front extension is 30"-37" W x 10.5" L x 5" H.
 1512-0077 angled front extension is 30"-37" W x 13" L x 5" H.
 1512-0078 angled front extension is 35"-41" W x 12" L x 8" H.
 1512-0079 straight rear extension is 35"-41" W x 17" L x 8" H.

RACK EXTENSIONS > \$99.95

Unique, adjustable width feature with spring locking buttons. Industry first adjustable corner angle (up to 30 degrees) fits almost any ATV rack. Strong steel tubular construction with lasered steel support plates. Easy to install universal mounting hardware works on most tubular or plastic OEM racks. Heavy-duty knobs allow you to add or remove extensions in seconds without tools. Black textured, powder-coated finish. Made in the USA.

FITS MODEL	FRONT PART #	REAR PART #
RACK EXTENSIONS		
ARCTIC CAT		
250 2X4 & 4X4 01	-	1512-0079
300 2X4 & 4X4 98-99	-	1512-0078
300 4X4 02-03	1512-0076	-
300 4X4 04	-	1512-0079
300 4X4 05	-	1512-0079
366 4X4 08-09	1512-0077	1512-0079
375 4X4 AUTOMATIC 02	1512-0076	-
400 4X4 (ALL NON-MRP RACKS) 02-04	1512-0076	-
400 4X4 (ALL) 06	1512-0077	1512-0079
400 4X4 (ALL) 07	1512-0077	1512-0078
400 4X4 (ALL) 08	1512-0077	1512-0079
400 4X4 (MRP) 04	-	1512-0079
400 4X4 ACT AUTOMATIC 05	1512-0076	1512-0079
400 4X4 TRV 06	1512-0077	1512-0078
400 4X4 TRV 09-10	1512-0077	-
4001 4X4 (MRP) 05	-	1512-0079
450 4X4 2011	1512-0077	1512-0078
454 4X4 96-98	-	1512-0079
500 4X4 08-09	1512-0077	1512-0079
500 4X4 99-01	-	1512-0079
500 4X4 (ALL NON-MRP RACKS) 02-04	1512-0076	-
500 4X4 05-07	1512-0077	1512-0078
500 4X4 TRV/TBX 06	1512-0077	-
550 4X4 09-11	1512-0077	1512-0079
550 4X4 TRV 09-11	1512-0077	-
650 4X4 (V2 & H1) 05-07	1512-0077	1512-0078
650 4X4 AUTOMATIC 04	-	1512-0079
650 4X4 AUTOMATIC LE 04	1512-0076	-
650 4X4 H-1 08	1512-0077	1512-0079
650 4X4 H-1 TRV 08	1512-0077	-
650 4X4 TBX 07	1512-0077	-
700 4X4 (& MUD-PRO) 08-12	1512-0077	1512-0079
700 4X4 H-1 07	1512-0077	1512-0078
700 4X4 H-1 TRV 08	1512-0077	-
1000 THUNDERCAT 08	1512-0077	1512-0079
CAN-AM		
OUTLANDER 330 4X4 04-05	-	1512-0078
OUTLANDER 400 (ALL) 03-05	-	1512-0078
OUTLANDER 400 (ALL) 06-08	1512-0077	1512-0078
OUTLANDER 400 MAX 2X4 05	-	1512-0078
OUTLANDER 500 (ALL) 07-11	1512-0076	1512-0078
OUTLANDER 650 06-10	1512-0077	1512-0078
OUTLANDER MAX 650 09-11	1512-0076	1512-0078
OUTLANDER 800 (ALL) 06-13	1512-0076	1512-0078
OUTLANDER 1000R 12	-	1512-0078

FITS MODEL	FRONT PART #	REAR PART #
RACK EXTENSIONS (CON'T)		
HONDA		
TRX250 2X4 RECON 97-13	-	1512-0079
TRX300 2X4 & 4X4 88-00	1512-0076	1512-0079
TRX350 2X4 & 4X4 RANCHER 00-06	1512-0076	1512-0079
TRX400 4X4 95-01	1512-0076	1512-0079
TRX400 RANCHER (ALL) 04-07	1512-0076	1512-0079
TRX420 RANCHER (ALL) 07-13	1512-0077	1512-0078
TRX450 4X4 S/ES 98-04	1512-0076	1512-0079
TRX500 FOREMAN PS (FOOT/EPS) 09	1512-0076	1512-0079
TRX500 FOREMAN/RUBICON (ALL) 05-13	1512-0076	1512-0079
TRX500 FOREMAN/RUBICON 01-04	1512-0076	1512-0079
TRX650/680 RINCON 03-13	1512-0076	1512-0079
KAWASAKI		
KLF250 BAYOU 2X4 05	-	1512-0079
KLF300 BAYOU 88-02	-	1512-0079
KVF300 PRAIRIE 2X4 01	1512-0076	1512-0079
KVF360 PRAIRIE 02-11	1512-0076	1512-0079
KVF400 PRAIRIE 4X4 97-98	-	1512-0079
BRUTE FORCE 650 (IND. SUSP) 06-11	1512-0077	1512-0078
BRUTE FORCE 650 (STR. AXLE) 09	1512-0077	1512-0079
KVF650 PRAIRIE 4X4 03	-	1512-0079
PRAIRIE 700 04-06	1512-0077	1512-0078
BRUTE FORCE 750 05-13	1512-0077	1512-0078
KYMCO		
300 MXU 2X4 06	-	1512-0079
500 MXU 4X4 07	-	1512-0079
POLARIS		
200 SAWTOOTH 2X4 06	-	1512-0079
250 TRAIL BOSS 88-99	1512-0076	-
300 MAGNUM 4X4 94-95	1512-0076	-
330 MAGNUM 03-05	-	1512-0078
330 TRAIL BOSS 04-09	-	1512-0079
400 SPORTSMAN 01-04	-	1512-0078
400 SPORTSMAN 05	-	1512-0079
400 SPORTSMAN 11	-	1512-0079 ¹
400 SPORTSMAN 94-97	1512-0076	-
400L 2X4 & 4X4 90-93	1512-0076	-
450 SPORTSMAN 06	-	1512-0079
500 SPORTSMAN 00-04	-	1512-0078
500 SPORTSMAN 05-09	-	1512-0079
500 SPORTSMAN 11	-	1512-0079 ¹
550 SPORTSMAN XP 11 (N/F TOURING MODEL)	1512-0077	1512-0078
600 SPORTSMAN 03-04	-	1512-0078
600 SPORTSMAN 05	-	1512-0079

FITS MODEL	FRONT PART #	REAR PART #
RACK EXTENSIONS (CON'T)		
POLARIS (CON'T)		
700 SPORTSMAN 02-04	-	1512-0078
700 SPORTSMAN 05-07	-	1512-0079
800 SPORTSMAN 05-09	-	1512-0079
800 SPORTSMAN 11	-	1512-0079 ¹
850 SPORTSMAN XP 09-11	1512-0077	1512-0078
ALL PLASTIC RACK MODELS 95-04	-	1512-0078
SUZUKI		
250 OZARK 2X4 03-06	-	1512-0076
250 OZARK 2X4 99-01	-	1512-0079
250 QUADRUNNER 2X4 99-01	-	1512-0079
250 QUADRUNNER 4X4 87-98	-	1512-0079
300 KING QUAD 4X4 02-06	-	1512-0076
300 KING QUAD 4X4 91-98	-	1512-0079
400 EIGER 4X4 02-07	1512-0076	1512-0079
400 EIGER 4X4 99-02	-	1512-0079
400 KING QUAD 08-12	1512-0077	1512-0079
450 KING QUAD 07-09	1512-0076	1512-0079
500 KING QUAD 09-12	1512-0077	1512-0079
500 QUADMASTER 4X4 98-01	1512-0076	1512-0079
500 QUADRUNNER 4X4 02-03	1512-0076	1512-0079
500 VINSON 4X4 00-01	1512-0076	1512-0079
500 VINSON 4X4 02-06	-	1512-0079
500 VINSON 4X4 07	1512-0076	1512-0079
700 KING QUAD 05-07	-	1512-0079
700 TWIN PEAKS 06	1512-0077	-
750 KING QUAD 08-13	1512-0077	1512-0079
YAMAHA		
250 BEAR TRACKER 05	1512-0076	1512-0079
250 BRUIN 96-00	-	1512-0079
250 TIMBERWOLF 05-06	-	1512-0076
350 BIG BEAR 99-03	1512-0076	1512-0079
350 BRUIN 4X4 04-06	1512-0076	1512-0079
350 BRUIN AUTO 4X4 00-03	-	1512-0079
350 GRIZZLY 4X4 07-08	1512-0076	1512-0079
350 GRIZZLY 4X4 I.R.S. 07-11	1512-0076	1512-0078
350 WOLVERINE 87-99	-	1512-0079
400 BIG BEAR 00-11	1512-0076	1512-0079
400 GRIZZLY 07	1512-0076	1512-0079
400 KODIAK 00-02	1512-0076	1512-0079
400 KODIAK 03-05	1512-0076	1512-0079
400 KODIAK 93-99	1512-0079	1512-0079
450 GRIZZLY 07-12	1512-0076	1512-0079
450 KODIAK 03-06	1512-0076	1512-0079
550 GRIZZLY 09-12	1512-0076	1512-0079
600 GRIZZLY 98-01	-	1512-0079
660 GRIZZLY 02-08	1512-0076	1512-0079
700 GRIZZLY 07-13	1512-0076	1512-0079

¹ REQUIRED ADDITIONAL BOLTS OUTLINED IN INSTRUCTION SHEET. NOTE: NEVER EXCEED MANUFACTURERS RECOMMENDED WEIGHT CAPACITY LIMITS.

PLOWS
WINCHES
UTV
RACKS
LUGGAGE
BODY
CONTROLS
ELECTRICAL
WHEELS & TIRES
SUSPENSION & DRIVE
ENGINE
NRA BY MOOSE
RIDER
TOWING
GARAGE
PROMO



FRONT



REAR

UNIVERSAL FRONT AND REAR MESH RACKS > \$169.95-\$199.95

Made out of 3/4" square 16 gauge tubing. 14 gauge diamond punched steel bottom and sides. Electro charged rubber coated finish for anti-rattling. Universal mounting hardware included. Made in the USA.

Front rack measures 37.375" W x 12.75" L x 6" D.

Rear rack measures 40.5" W x 22.5" L x 6" D.

DESCRIPTION	PART #
UNIVERSAL FRONT RACK	1512-0104
UNIVERSAL FRONT RACK WITH SLOT (FOR ATV'S WITH FRONT RAIL THAT STICKS UP)	1512-0105
UNIVERSAL REAR RACK	1512-0103

NOTE: NEVER EXCEED MANUFACTURERS RECOMMENDED WEIGHT CAPACITY LIMITS.



TREE STAND CARRIER > \$44.95

Tension system with coated arms, grips and protects your stand. Carrier includes a drilled hole for an additional bungee strap for extra support. Tree stand not included. Made in the USA.

DESCRIPTION	PART #
TREE STAND CARRIER	MUOTS4



TOOL HOLDER > \$16.95

Securely holds all tools and other gear with standard 1 1/4" inch diameter handles. Carries garden and ranch tools, fishing rods, and more. Shovel not included. Imported.

DESCRIPTION	PART #
TOOL HOLDER	1512-0046



ICE AUGER CARRIER > \$99.95

Fully adjustable and easy to use, this carrier mounts to the ATV's rack to keep the ice auger from rolling around and protect the blade's edge and the finish on your rack. Designed to transport safely and conveniently gas powered ice augers with up to 10" diameter blades. Includes all mounting hardware. Auger not included. Made in the USA.

DESCRIPTION	PART #
ICE AUGER CARRIER	1512-0139



VERTICAL TOOL HOLDER > \$20.95

Tool can be carried either horizontal or vertical. Carries shovels, rakes, hoes, and any other handled tools on your ATV. Shovel not included. Imported.

DESCRIPTION	PART #
VERTICAL TOOL HOLDER	1512-0047



CHAINSAW HOLDER > \$86.95

The most versatile chainsaw holder on the market. Heavy-duty powder coated steel construction. Multi angle mounting. Equipped with a premium bar guard for maximum safety. Holds any model chainsaw with up to a 24" bar. Chainsaw not included. Made in the USA.

DESCRIPTION	PART #
CHAINSAW HOLDER	1512-0133



BACK REST > \$117.95

Framed from aircraft aluminum and the 2" thick cushioned back is covered with high-density, waterproof, 400 denier nylon. Attaches to ATV rear cargo racks with u-bolts. Convenient adjustment feature to set the backrest at the desired position and angle. Folds flat for safe transport. Made in the USA.

DESCRIPTION	PART #
BACK REST	3550-0086



UTILITY CAN CARRIER > \$51.95

Fits on front or rear tubular metal ATV racks. Holds Wedco gas cans; not included. Inside dimensions 12 1/4" x 8". Not for Honda Rincon or Polaris composite racks. Made in the USA.

DESCRIPTION	PART #
UTILITY CAN CARRIER	MUD4713



QUICK RELEASE CHAINSAW HOLDER > \$78.95

Designed to hold any type of chainsaw. Chainsaw not included. (Requires the purchase of one quick release mount; sold on this page) Made in the USA.

DESCRIPTION	PART #
QUICK RELEASE CHAINSAW HOLDER	1512-0017



QUICK RELEASE 5-GALLON BUCKET HOLDER > \$54.95

Holds any 5-gallon bucket with a 12" diameter top. Great for ice anglers. Bucket not included. (Requires the purchase of one quick release mount; see below) Made in the USA.

DESCRIPTION	PART #
QUICK RELEASE 5-GAL. BUCKET HOLDER	1512-0015



QUICK RELEASE MOUNT > \$39.95

Mount uses a receiver-style system to attach accessories to your ATV. Utilizes more of your ATV's rack space. Constructed of 7-gauge steel. 1" square tubing used for receiver plugs. Not for composite racks. Made in the USA.

DESCRIPTION	PART #
QUICK RELEASE MOUNT	1512-0011





25 GALLON SPOT SPRAYER > \$219.95

2.1 GPM High-Flo pump. 60 psi. Corrosion resistant polyethylene tank. Full drain out capability with molded in drain port, cap and tether. 5" fill lid with tether. Full length drain sump. Larger hose wrap horns for storage. Both gallon and liter fluid volume indicator on tank. Molded wand clips. On/Off switch, fuse, 96" lead wire with quick disconnect included. Solid suction tube. Pistol grip handwand with adjustable pattern tip and 15' hose. Must use straps / tie-downs. Straps / tie-downs not included. Made in the USA.

25 GALLON DELUXE SPOT SPRAYER > \$299.95

3.8 GPM High-Flo pump. 45 psi. "Y" valve for adjustable pressure and a glycerin filled pressure gauge. Corrosion resistant polyethylene tank. Lower tank profile for improved stability. Full drain out capability with molded in drain port, cap and tether. 5" fill lid with tether. Full length drain sump. Larger hose wrap horns for storage. Both gallon and liter fluid volume indicator on tank. Molded wand clips. On/Off switch, fuse, 96" lead wire with quick disconnect included. Solid suction tube. Pistol grip handwand with adjustable pattern tip and 15' hose. Must use straps / tie-downs. Straps / tie-downs not included. Made in the USA.

DESCRIPTION	PART #
25 GALLON 2.1 GPM SPOT SPRAYER	4503-0048
25 GALLON DELUXE 3.8 GPM SPOT SPRAYER	4503-0049

NOTE: NEVER EXCEED MANUFACTURERS RECOMMENDED WEIGHT CAPACITY LIMITS.



15 GALLON SPOT SPRAYER (NO BOOM AVAILABLE) > \$142.95

1.0 GPM High-Flo pump. 35 psi. Corrosion resistant polyethylene tank. Full drain out capability with molded in drain port, cap and tether. 5" fill lid with tether. Full length drain sump. Larger hose wrap horns for storage. Both gallon and liter fluid volume indicator on tank. Molded wand clips. On/Off switch, fuse, 96" lead wire with quick disconnect included. Solid suction tube. Standard 18" handwand with adjustable pattern tip and 15' hose. No booms are available for this model. Must use straps / tie-downs. Straps / tie-downs not included. Made in the USA.

DESCRIPTION	PART #
15 GALLON 1.0 GPM SPOT SPRAYER	4503-0047

NOTE: NEVER EXCEED MANUFACTURERS RECOMMENDED WEIGHT CAPACITY LIMITS.



REPLACEMENT SPRAYER PUMPS

> \$18.95-\$114.95

DESCRIPTION	PART #
1.0 GPM HIGH FLO	4503-0053
2.1 GPM HIGH FLO	4503-0054
3.8 GPM HIGH FLO	4503-0055
REPLACEMENT SPRAYER HANDGUN	4503-0056



3' NOZZLE "BOOMLESS" KIT > \$245.95

3' Nozzle Boom. Full 30" of spray coverage. Specially designed nozzles each have individual shut off's, and check valves, includes fittings to connect to most sprayers. Will only work with the 25 Gal 3.8 sprayer systems. Nozzles can be adjusted to spray right, left, center or all three. Nozzles can also be adjusted up or down depending on spray needs. Made in the USA.

DESCRIPTION	PART #
3' NOZZLE "BOOMLESS" KIT	4503-0052

NOTE: NEVER EXCEED MANUFACTURERS RECOMMENDED WEIGHT CAPACITY LIMITS.

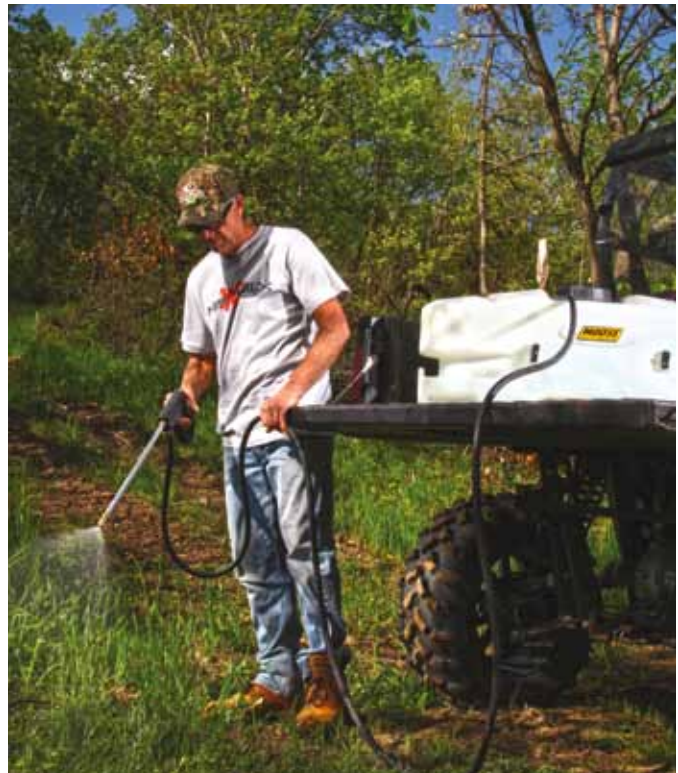



7 NOZZLE BOOM KIT > \$259.95

7 Nozzle Boom. 140" coverage. 3 section folding boom. Includes fittings to connect to most spot sprayers. Will not work with the 15 gallon 1 GPM model. Made in the USA.

DESCRIPTION	PART #
7 NOZZLE 140" BOOM KIT	4503-0051



5 NOZZLE BOOM KIT > \$231.95

5 Nozzle Boom. 100" coverage. Fold behind boom. Includes fittings to connect to most spot sprayers. Will not work with the 15 gallon 1 GPM model. Made in the USA.

DESCRIPTION	PART #
5 NOZZLE 100" BOOM KIT	4503-0050



PLOWS

WINCHES

UTV

RACKS

LUGGAGE

BODY

CONTROLS

ELECTRICAL

WHEELS & TIRES

SUSPENSION & DRIVE

ENGINE

NRA BY MOOSE

RIDER

TOWING

GARAGE

PROMO





SPREADER > \$7.95-\$479.95

Spreads everything from seed, dry granular fertilizers, pesticides and ice melting materials. 2.2 cubic foot poly hopper. 12 volt motor with variable speed control and on/off switch. Variable speed control allows you to vary spread width from 5 to 45 feet. Material agitator and stainless steel radial 6-blade fan. Holds up to 145 lbs. Not for use with sand. Mounting hardware included. Made in the USA.

DESCRIPTION	PART #	REPLACEMENT PARTS	PART #
SPREADER	4503-0057	CONTROLLER	4503-0062
SPREADER COVER	4503-0058	MOTOR	4503-0046

NOTE: NEVER EXCEED MANUFACTURERS RECOMMENDED WEIGHT CAPACITY LIMITS.



SPREADER RECEIVER HITCHES > \$75.95-\$99.95

Adapt the Moose spreader (part # 4503-0057) onto any vehicle with a 2" or 1 1/4" receiver box. Spreader not included. Made in the USA.

DESCRIPTION	PART #
2"	4503-0060
1 1/4"	4503-0061

- PLOWS
- WINCHES
- UTV
- RACKS**
- LUGGAGE
- BODY
- CONTROLS
- ELECTRICAL
- WHEELS & TIRES
- SUSPENSION & DRIVE
- ENGINE
- NRA BY MOOSE
- RIDER
- TOWING
- GARAGE
- PROMO



BOW GRIP PRO > \$38.95

Adjust-to-fit spline technology creates a custom fit on the limbs of any bow. Soft rubber blocks cushion and protect bow from shock damage. The most simple and effective bow transportation system on the market. Bow not included. Imported.

DESCRIPTION	PART #
BOW GRIP PRO	3518-0051



EXPEDITION SINGLE GUN RACK > \$35.95

Has soft rubber fins and extra rubber in the bottom to hold your gun securely. Patented fin design uses alternating long and short rubber fins that don't bind up and help cushion the gun. Aluminum blocks attach to handlebars or racks. Twist the fork and lock the wing nut for a tighter fit. Can also be mounted to front or rear rack. Gun not included. Imported.

DESCRIPTION	PART #
EXPEDITION SINGLE GUN RACK	3518-0029



RIDGETOP SINGLE GUN RACK > \$38.95

Uses internal steel forks covered with soft rubber to firmly hold guns. Soft rubber fins help provide superior shock absorption. Mounting base attaches to all ATV's and can be mounted to metal racks or flat cargo racks. Gun not included. Imported.

DESCRIPTION	PART #
RIDGETOP SINGLE GUN RACK	3518-0026



BIGHORN SINGLE GUN RACK > \$30.95

Rubber coated rack attaches to regular or flat cargo racks. Nylon core is flexible and the one piece design means no parts will vibrate loose. Patented offset design allows for more use of cargo space. Soft rubber spurs help hold items securely. Gun not included. Imported.

DESCRIPTION	PART #
BIGHORN SINGLE GUN RACK	3518-0030



OZARK DOUBLE GUN RACK > \$63.95

One of the most durable double ATV gun racks on the market. Utilizes high-quality components and a steel t-bar for extra strength. Easily carries two guns on an ATV. The rack can be rotated 360° allowing for a wide range of adjustments on any brand of ATV. Mounting base attaches to all ATV's and can be mounted to metal racks or flat cargo racks. Guns not included. Imported.

DESCRIPTION	PART #
OZARK DOUBLE GUN RACK	3518-0027



AXIS DOUBLE GUN RACK > \$44.95

Easily carries two guns on an ATV. Rubber coated rack attaches to regular or flat cargo racks. Nylon core is flexible and the one piece design means no parts will vibrate loose. Patented offset design allows for more use of cargo space. Soft rubber spurs help hold items securely. Guns not included. Imported.

DESCRIPTION	PART #
AXIS DOUBLE GUN RACK	3518-0046



FLEXGRIP™ PRO-SINGLE > \$41.95

Features 15% larger forks for extended carrying capabilities. 360° of rotation and 16 inches of width adjustment. Adjustable without tools. Variable fit technology provides a custom fit for guns, guns in a soft case and bows. Bow limb slot keeps bows stable and is compatible with parallel limb designs. Suspension isolates shock and vibration for protection. Adjustable, low-profile bases provide a custom fit on tubular or composite racks. Gun not included. Imported.

DESCRIPTION	PART #
FLEXGRIP™ PRO-SINGLE	3518-0054



FLEXGRIP™ PRO-DOUBLE > \$71.95

Features 15% larger forks for extended carrying capabilities. 360° of rotation and 16 inches of width adjustment. Adjustable without tools. Variable fit technology provides a custom fit for guns, guns in a soft case and bows. Bow limb slot keeps bows stable and is compatible with parallel limb designs. Suspension isolates shock and vibration for protection. Adjustable, low-profile bases provide a custom fit on tubular or composite racks. Guns not included. Imported.

DESCRIPTION	PART #
FLEXGRIP™ PRO-DOUBLE	3518-0055



FLEXGRIP™ SINGLE GUN RACK > \$56.95

The mounting base indexes into the Polaris Lock-N-Ride holes and comes with both UTV & ATV sizes. 15% larger forks for extended carrying capabilities. 360 degrees of rotation and amazing width adjustment or offset adjustment for the perfect fit every time. Guns not included. Imported.

DESCRIPTION	PART #
FLEXGRIP™ SINGLE GUN RACK	3518-0062



FLEXGRIP™ DOUBLE GUN RACK > \$96.95

The mounting base indexes into the Polaris Lock-N-Ride holes and comes with both UTV & ATV sizes. 15% larger forks for extended carrying capabilities. 360 degrees of rotation and amazing width adjustment or offset adjustment for the perfect fit every time. Guns not included. Imported.

DESCRIPTION	PART #
FLEXGRIP™ DOUBLE GUN RACK	3518-0063





V-GRIP™ SINGLE > \$35.95

Variable Fit Technology provides a custom fit for guns, guns in a soft case and bows. Adjustable without tools. Bow limb slot keeps bows stable and is compatible with parallel limb designs. Suspension isolates shock and vibration for protection. Adjustable, low-profile bases provide a custom fit on tubular or composite racks. Gun not included. Imported.

DESCRIPTION	PART #
V-GRIP™ SINGLE	3518-0056

V-GRIP™ DOUBLE > \$59.95

Variable fit technology provides a custom fit for guns, guns in a soft case and bows. Adjustable without tools. Bow limb slot keeps bows stable and is compatible with parallel limb designs. Suspension isolates shock and vibration for protection. Adjustable, low-profile bases provide a custom fit on tubular or composite racks. Guns not included. Imported.

DESCRIPTION	PART #
V-GRIP™ DOUBLE	3518-0057

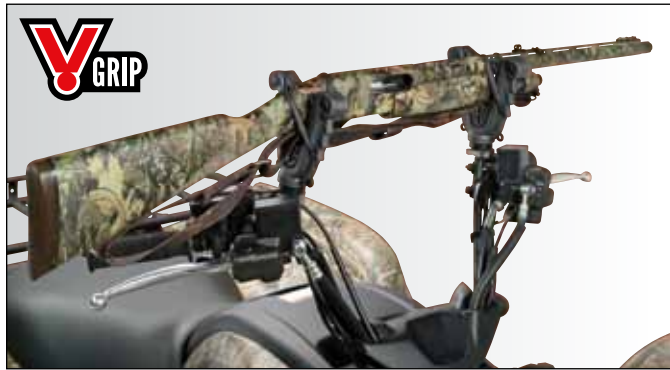

V-GRIP™ HANDLEBAR > \$29.95

Variable fit technology provides a custom fit for guns, guns in a soft case and bows. Adjustable without tools. Bow limb slot keeps bows stable and is compatible with parallel limb designs. Suspension isolates shock and vibration for protection. Adjustable, low-profile bases provide a custom fit on tubular or composite racks. Gun not included. Imported.

DESCRIPTION	PART #
V-GRIP™ HANDLEBAR	3518-0058



REPLACEMENT RUBBER SNUBBERS > \$3.95-\$5.95

Available for both styles of gun racks. Sold in pairs. Imported.

DESCRIPTION	PART #
FLEXGRIP™ AND V-GRIP™ GUN RACKS	3518-0059
OFFSET AND OLDER MOOSE GUN RACKS	3518-0031
FOR SINGLE AND DOUBLE GUN RACKS	3518-0032

GUN BOOT WITH BRACKET > \$114.95

Includes a removable, shock absorbing foam and nylon impact liner that provides interior protection within the hard case. The hard case has an ergonomically designed handle for carrying and molded attachment points for a sling. Designed to accommodate left and right hand bolt action rifles and shotguns providing ample room for 50mm scopes and rifles with slings. Gun boot mounts quickly into the all-metal, rubber-coated loop bracket along with a locking pin. Bracket can be adjusted to multiple angle positions between 0° and 45°. Compact design of the bracket provides universal fitment to most ATV racks leaving room for other items. Made in the USA.

DESCRIPTION	PART #
GUN BOOT WITH BRACKET	3518-0022

OZARK - BLACK



OZARK - MOSSY OAK BREAK-UP®



OZARK - REALTREE AP™



OZARK REAR RACK BAG > \$125.95-\$136.95

Rigid bag mounts easily to your ATV's rear rack. Zippered top flap provides access to large storage compartment. High-density foam seat pad integrated into bag. Do not use as seat while riding. Movable, internal dividers, key clip and zippered mesh pockets provide plenty of ways to store cargo. External loop system allows you to easily strap additional cargo (bow, gun, shovels etc.) to the bag. Four outside pockets, key clip and an elastic cord for securing riding apparel give you quick access to your gear. Internal mesh pockets, one with security zipper, help organize cargo. External, mesh storage pockets allow easy access to favorites (drink bottle, tools, etc). The finest materials create a rugged, water-resistant fabric case which resists the elements and cleans up easily with a damp cloth. 36" L x 19" W x 8" H. Contents not included. Imported.

DESCRIPTION	PART #
BLACK	3505-0121
MOSSY OAK BREAK-UP®	3505-0122
REALTREE AP™	3505-0151



INTERNAL POCKETS





PROMO	GARAGE	TOWING	RIDER	NRA BY MOOSE	ENGINE	SUSPENSION & DRIVE	WHEELS & TIRES	ELECTRICAL	CONTROLS	BODY	LUGGAGE	RACKS	UTV	WINCHES	PLOWS
-------	--------	--------	-------	--------------	--------	--------------------	----------------	------------	----------	------	----------------	-------	-----	---------	-------

RIDGETOP - BLACK



RIDGETOP - MOSSY OAK BREAK-UP®



RIDGETOP - REALTREE AP™



RIDGETOP REAR RACK BAG > \$104.95-\$114.95

Rigid bag mounts easily to your ATV's rear rack. Zippered top flap provides access to large storage compartment. High-density foam seat pad integrated into bag. Do not use as seat while riding. Movable, internal dividers, key clip and two zippered mesh pockets provide plenty of ways to store and protect cargo. External loop system allows you to easily strap additional cargo (bow, fishing rods, gun, shovels etc.) to the bag. External elastic cord secures riding apparel provides quick access to gear. External shotgun shell holder (holds more than 15 shells), and a handy tool holder, puts what you need at your fingertips. External, mesh storage pockets permit easy access to favorites (drink bottle, tools, etc). The finest materials combine to create a rugged, water-resistant fabric case which resists the elements and cleans up easily with a damp cloth. 37" L x 19" W x 12" H. Contents not included. Imported.

DESCRIPTION	PART #
BLACK	3505-0123
MOSSY OAK BREAK-UP®	3505-0124
REALTREE AP™	3505-0152

EXTERNAL POCKETS



BIGHORN - BLACK



BIGHORN - MOSSY OAK BREAK-UP®



EXTERNAL LOOP SYSTEM FOR CARGO



BIGHORN REAR RACK BAG > \$147.95-\$157.95

Rigid bag mounts easily to your ATV's rear rack. Zippered top flap provides access to a large storage compartment. Insulated storage bag doubles as a cooler, great for keeping items hot or cold. Movable, internal dividers, key clip and zippered mesh pockets provide plenty of ways to store cargo. External loop system allows you to easily strap cargo (bow, gun, shovels etc.) to the bag. Four outside pockets, key clip and elastic cord for securing riding apparel give you quick access to your gear. Internal mesh storage pockets, one with security zipper, help organize your cargo. Mesh storage pockets on the outside of the bag permit quick access to favorites (drink bottle, tools, etc). The finest materials create a rugged, water-resistant fabric case which resists the elements and cleans up easily with a damp cloth. 34" L x 20 1/2" W x 11" H. Contents not included. Imported.

DESCRIPTION	PART #
BLACK	3505-0125
MOSSY OAK BREAK-UP®	3505-0126



LARGE STORAGE COMPARTMENT

- PLOWS
- WINCHES
- UTV
- RACKS
- LUGGAGE**
- BODY
- CONTROLS
- ELECTRICAL
- WHEELS & TIRES
- SUSPENSION & DRIVE
- ENGINE
- NRA BY MOOSE
- RIDER
- TOWING
- GARAGE
- PROMO

EXPEDITON - BLACK



EXPEDITON - MOSSY OAK BREAK-UP®



REMOVABLE INSULATED TUBE



EXPEDITION RACK BAG > \$147.95-\$157.95

Rigid bag mounts easily to your ATV's front or rear rack. Zippered top flap provides access to a large storage compartment. Insulated storage bag doubles as a cooler great for keeping items hot or cold. Movable, internal dividers and zippered mesh pockets provide plenty of ways to store cargo. Modular concept design bag has sturdy D-rings for easy attachment to other Moose Utility Division bags. External loop system allows you to easily strap cargo (bow, gun, shovels etc.) to the bag. Two outside, removable bags help you stow, organize and carry gear (fits standard plastic organizers or tackle boxes). Removable insulated tube is perfect for drinks, fishing rods, tent poles, etc. External mesh storage pocket allows quick access to favorites (drink bottle, tools, etc). The finest materials create a rugged, water-resistant fabric case which resists the elements and cleans up easily with a damp cloth. 32" L x 12" W x 11" H. Contents not included. Imported.

DESCRIPTION	PART #
BLACK	3505-0129
MOSSY OAK BREAK-UP®	3505-0130



REMOVABLE OUTSIDE BAGS/COOLER

AXIS - BLACK



AXIS - MOSSY OAK BREAK-UP®



THREE COMPARTMENTS



AXIS FRONT RACK BAG > \$89.95-\$99.95

Rigid bag mounts easily to your ATV's front or rear rack. Clamshell, zippered top flap provides full access to three-section storage compartment. Weather-resistant flaps work to keep the elements at bay and protect cargo. Outside pockets with key clip help you stow and organize gear. External mesh storage pocket allows quick access to favorites (drink bottle, tools, etc). The finest materials combine to create a rugged, water-resistant fabric case which resists the elements and cleans up easily with a damp cloth. 31" L x 11" W x 10" H. Contents not included. Imported.

DESCRIPTION	PART #
BLACK	3505-0127
MOSSY OAK BREAK-UP®	3505-0128



QUARTER-TURN HASPS

- PLOWS
- WINCHES
- UTV
- RACKS
- LUGGAGE**
- BODY
- CONTROLS
- ELECTRICAL
- WHEELS & TIRES
- SUSPENSION & DRIVE
- ENGINE
- NRA BY MOOSE
- RIDER
- TOWING
- GARAGE
- PROMO



BIGHORN - BLACK



BIGHORN - MOSSY OAK BREAK-UP®



MESH STORAGE POCKETS



BIGHORN - REALTREE AP™

BIGHORN FENDER BAG > \$26.95-\$27.95

Form-fitting bag mounts easily to your ATV's rack and fenders. Zippered storage compartments with weather-resistant flaps open easily and keep the elements at bay. Internal mesh storage pocket and key clip helps you organize cargo. Exterior, elastic mesh storage pocket permits easy access to favorites (drink bottle, ammo clips, etc). The finest materials combine to create a rugged, water-resistant fabric case which resists the elements and cleans up easily with a damp cloth. Bags are attached to each other and cannot be used separately. Contents not included. 7" L x 6" W x 2 1/2" H. / 12" L x 7" W x 2 1/2"-3 1/2" H. Imported.

DESCRIPTION	PART #
BLACK	3509-0009
MOSSY OAK BREAK-UP®	3509-0010
REALTREE AP™	3509-0015



QUARTER-TURN HASPS



EXPEDITION - BLACK



EXPEDITION - MOSSY OAK BREAK-UP®



TWO INTERNAL POCKETS

EXPEDITION FENDER BAG > \$29.95-\$34.95

Form-fitting bag mounts easily to your ATV's rack and fenders. Zippered storage compartments protect your belongings and include an internal key clip. Weather-resistant flap opens easily, keeps the elements at bay and away from your cargo. Quarter-turn hasps accept mini-padlocks for security. Two internal, mesh storage pockets, one with a security zipper, gives you plenty of ways to store cargo. External, elastic mesh storage pocket provides convenient access to favorites (drink bottle, ammo clips, etc). The finest materials combine to create a rugged, water-resistant fabric case which resists the elements and cleans up easily with a damp cloth. 18" L x 9" W x 2-4" H. Contents not included. Imported.

DESCRIPTION	PART #
BLACK	3509-0011
MOSSY OAK BREAK-UP®	3509-0012



WATER-RESISTANT FABRIC

- PLOWS
- WINCHES
- UTV
- RACKS
- LUGGAGE**
- BODY
- CONTROLS
- ELECTRICAL
- WHEELS & TIRES
- SUSPENSION & DRIVE
- ENGINE
- NRA BY MOOSE
- RIDER
- TOWING
- GARAGE
- PROMO

BIGHORN - BLACK



BIGHORN - MOSSY OAK BREAK-UP®



BIGHORN - REALTREE AP™



BIGHORN TANK BAG > \$29.95-\$34.95

Non-slip yoke with hook & loop fasteners installs quickly on all ATV's, with or without a central top gas cap. Compact, quick-release, side storage compartments allow you to bring your belongings with you. Two internal storage dividers keep your belongings organized. Elastic mesh storage pocket on the outside of each bag permit easy access to favorites (drink bottle, etc). Weather-resistant flaps open easily, keep the elements at bay and away from your cargo. Rugged, water-resistant fabric cleans up easily with just a damp cloth. 10 1/2" L x 10 1/2" W x 3 1/2" H. Contents not included. Imported.

DESCRIPTION	PART #
BLACK	3502-0159
MOSSY OAK BREAK-UP®	3502-0160
REALTREE AP™	3502-0173

QUICK-RELEASE SIDE STORAGE



EXPEDITION - BLACK



EXPEDITION - MOSSY OAK BREAK-UP®



SIDE STORAGE



EXPEDITION TANK BAG > \$34.95-\$39.95

Non-slip yoke installs quickly with hook & loop fasteners under your ATV's gas cap. Large, quick-release side storage compartments allow you to bring your belongings with you. Quarter-turn hasps accept mini-padlocks for security. Internal storage pockets (two zippered and two elastic mesh) with a key clip in each storage compartment. Elastic mesh storage pocket on the outside of each bag permits easy access to favorites (drink bottle, etc). Weather-resistant flaps open easily, keep the elements at bay and away from your cargo. The finest materials combine to create a rugged, water-resistant fabric case which resists the elements and cleans up easily with a damp cloth. 11" L x 9" W x 3 1/2"-5" H. Contents not included. Imported.

DESCRIPTION	PART #
BLACK	3502-0161
MOSSY OAK BREAK-UP®	3502-0162

WATER-RESISTANT FABRIC



- PLOWS
- WINCHES
- UTV
- RACKS
- LUGGAGE**
- BODY
- CONTROLS
- ELECTRICAL
- WHEELS & TIRES
- SUSPENSION & DRIVE
- ENGINE
- NRA BY MOOSE
- RIDER
- TOWING
- GARAGE
- PROMO

BIGHORN BOW BAG - CLOSED



BIGHORN BOW BAG - OPEN



BIGHORN BOW BAG - MOUNTED ON BIGHORN RACK BAG



BIGHORN BOW BAG - QUIVER POCKET



BIGHORN BOW BAG > \$64.95

Quality bow bag with riveted straps and carrying handles. Rugged water resistant 600 denier nylon stands up to the toughest elements and cleans up easily. Four smaller pockets and one large pocket on top, plenty of room to hold bow release and other accessories. One large long pocket on bottom of bag to hold quiver with arrows. Measures 40" L x 17" W. Universal fit. Designed to sit on ATV's rack or on top of the Big Horn Rear Rack bags (see page 59). Mossy Oak Break-Up®. Contents not included. Bungee cords not included. Imported.

RACK COOLER BAG > \$57.95

Quick release straps attach the bag to the rack. Handy shoulder strap to carry like a duffel bag. Measures 21" L x 12" W x 10 1/2" H. Mossy Oak Break-Up®. Contents not included. Imported.

DESCRIPTION	PART #
BIG HORN BOW BAG	3505-0164

DESCRIPTION	PART #
RACK COOLER BAG	MUDCB1



CLOSED



OPEN

FRONT STORAGE TRUNK > \$129.95

Manufactured from black LLDPE (linear low-density polyethylene). Rugged, rotational-molded construction. Single wall base allows for maximum storage space. Double wall lid provides additional durability. Includes two, key-lockable latches. Measures 30" W x 13" D x 10" H. Made in the USA.

DESCRIPTION	PART #
FRONT STORAGE TRUNK	3505-0161

NOTE: NEVER EXCEED MANUFACTURERS RECOMMENDED WEIGHT CAPACITY LIMITS.



3505-0163

CLOSED



3505-0162

CLOSED



3505-0163

OPEN



3505-0162

OPEN

OVERSIZED REAR STORAGE TRUNK > \$199.95

Manufactured from black LLDPE (linear low-density polyethylene). Rugged, rotational-molded construction. Single wall base allows for maximum storage space. Double wall lid provides additional durability. Includes a single, centered reflector. Includes two, key-lockable latches. Measures 43" W x 21" D x 18" H. Made in the USA.

DESCRIPTION	PART #
OVERSIZED REAR STORAGE TRUNK	3505-0163

NOTE: NEVER EXCEED MANUFACTURERS RECOMMENDED WEIGHT CAPACITY LIMITS.

REAR STORAGE TRUNK > \$149.95

Manufactured from black LLDPE (linear low-density polyethylene). Rugged, rotational-molded construction. Single wall base allows for maximum storage space. Double wall lid provides additional durability. Includes a single, centered reflector. Includes two, key-lockable latches. Measures 37" W x 17" D x 14.5" H. Made in the USA.

DESCRIPTION	PART #
REAR STORAGE TRUNK	3505-0162

NOTE: NEVER EXCEED MANUFACTURERS RECOMMENDED WEIGHT CAPACITY LIMITS.

PLOWS

WINCHES

UTV

RACKS

LUGGAGE

BODY

CONTROLS

ELECTRICAL

WHEELS & TIRES

SUSPENSION & DRIVE

ENGINE

NRA BY MOOSE

RIDER

TOWING

GARAGE

PROMO



CLOSED



3505-0047

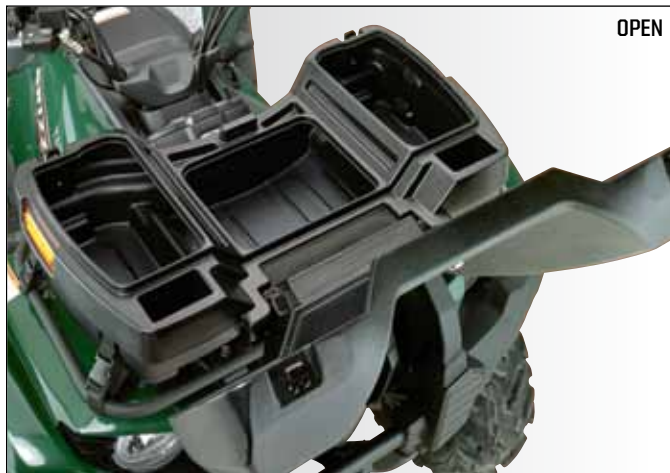

OPEN



3505-0048

FORESTER STORAGE TRUNK > \$144.95

Made from easy to clean, high-impact resistant polyethylene. UV stabilized. Built in enclosure to store cans. Lockable latches. Fits most ATVs and includes u-bolts for mounting. Measures 32" L x 18" W x 11" D. Imported.

DESCRIPTION	PART #
FORESTER STORAGE TRUNK	3505-0132

NOTE: NEVER EXCEED MANUFACTURERS RECOMMENDED WEIGHT CAPACITY LIMITS.

FRONT AND REAR ALUMINUM BOXES > \$189.95-\$214.95

Diamond plate, aluminum construction is durable/rust resistant. Black powder-coated finish resists cracking/fading. Black stainless steel, lockable latches (keys included) with double post hooks provide extra security. Lids include gas-mounted shocks and weather stripping. Drain holes provide air circulation and easy cleaning. Includes an anti-slip mat. Mounting kit included. Some drilling required. Measures: Front- 32.5" L x 12.75" W x 6.5" H, Rear- 35.5" L x 14" W x 14.25" H. Made in the USA.

DESCRIPTION	PART #
FRONT ALUMINUM BOX	3505-0047
REAR ALUMINUM BOX	3505-0048

NOTE: NEVER EXCEED MANUFACTURERS RECOMMENDED WEIGHT CAPACITY LIMITS.



3505-0023



3505-0024

FRONT AND REAR CARGO BOXES > \$134.95-\$194.95

Durable polyethylene with UV stabilizers. Rubber seal keeps water and dust out. Comes with necessary hardware, lockable latches and durable molded-in binges. Front box dimensions: 34" L x 18" W x 8" H, 2.26 cubic feet capacity. Rear box dimensions: 46" L x 23" W x 12" H, 4.2 cubic feet capacity. Made in the USA.

DESCRIPTION	PART #
FRONT BOX	3505-0023
REAR BOX	3505-0024

NOTE: NEVER EXCEED MANUFACTURERS RECOMMENDED WEIGHT CAPACITY LIMITS.



DELUXE LOUNGER TRUNK > \$249.95

Manufactured from durable, rotomolded LLDPE (linear low-density polyethylene). Black with textured finish. UV resistant. Single wall body allows for maximum storage space. Double wall lid provides extra rigidity. Provides 4,390 cubic inches of storage each (2.54 cubic feet / 19 gallons). Includes two key-lockable latches for added security. Features high quality, comfortable closed cell foam seat pad and arm pads. Perfect for taking a break from the trails. Installs easily with universal fit mounting hardware. Fits most ATVs. NOTE: Not for passenger use. 27.5" L x 37" W x 17" H. Made in the USA.

DESCRIPTION	PART #
DELUXE LOUNGER TRUNK	3505-0166

NOTE: NEVER EXCEED MANUFACTURERS RECOMMENDED WEIGHT CAPACITY LIMITS.



TRAILBLAZER STORAGE TRUNK > \$2.95-\$317.95

Made from easy to clean, high-impact resistant polyethylene. Equipped with rear brake light, key lock lid, and security reflectors on both sides. Center area allows more space for relaxing while stopped. Not for use as seat while riding. Large storage capacity. U-bolts used for mounting. Can be adapted to most types of ATVs. Measures 40" L x 26" W x 17 1/2" H. Imported.

DESCRIPTION	PART #
TRAILBLAZER STORAGE TRUNK	3505-0120
REPLACEMENT BULB	2060-0210
REPLACEMENT LENS	2010-0729

NOTE: NEVER EXCEED MANUFACTURERS RECOMMENDED WEIGHT CAPACITY LIMITS.

OUTDOORSMAN STORAGE TRUNK > \$2.95-\$257.95

Made from easy to clean, high-impact resistant polyethylene. Large access door for storage. UV stabilized. Integrated rear brake light. Key lock lid. Top loops for strap locations. U-bolts used for mounting. Can be adapted to most types of ATVs. Measures 37 1/4" L x 22" W x 15 1/4" D. Imported.

DESCRIPTION	PART #
OUTDOORSMAN STORAGE TRUNK	3505-0131
REPLACEMENT BULB	2060-0210
REPLACEMENT LENS	2010-0729

NOTE: NEVER EXCEED MANUFACTURERS RECOMMENDED WEIGHT CAPACITY LIMITS.

- PLOWS
- WINCHES
- UTV
- RACKS
- LUGGAGE**
- BODY
- CONTROLS
- ELECTRICAL
- WHEELS & TIRES
- SUSPENSION & DRIVE
- ENGINE
- NRA BY MOOSE
- RIDER
- TOWING
- GARAGE
- PROMO



3505-0088



3505-0096



3505-0089



3505-0090

FRONT BASKETS > \$57.95-\$109.95

Durable, vacuum formed basket at a lesser price than a rotational molded basket. Basket only; front basket with cover also available. Measures: 34" L x 16.75" W x 4.5" D. Made in the USA.

DESCRIPTION	PART #
FRONT BASKET	3505-0088
FRONT BASKET W/ COVER	3505-0089

NOTE: NEVER EXCEED MANUFACTURERS RECOMMENDED WEIGHT CAPACITY LIMITS.

REAR BASKET > \$71.95-\$78.95

Durable, vacuum formed basket at a lesser price than a rotational molded basket. Basket only; rear basket with cover also available. Measures: 44" L x 22.5" W x 6" D. Made in the USA.

DESCRIPTION	PART #
REAR BASKET	3505-0096
BASKET COVER	3505-0090

NOTE: NEVER EXCEED MANUFACTURERS RECOMMENDED WEIGHT CAPACITY LIMITS.



REAR DROP BASKET > \$149.95

Made of durable, medium density polyethylene. Mounts with u-bolts and wing nuts. Molded-in mounting locations provide universal mounting on ATV rear racks. Molded-in drain holes. Does not fit Polaris composite rack. Measures 32" L x 44" W x 9.5" H. Made in the USA.

DESCRIPTION	PART #
REAR DROP BASKET	3505-0091

NOTE: NEVER EXCEED MANUFACTURERS RECOMMENDED WEIGHT CAPACITY LIMITS.



PROSPECTOR FRONT STORAGE TRUNK > \$159.95

Made from easy to clean, high impact-resistant polyethylene. UV stabilized. Comes equipped with locking latches and side reflectors. Secured with either quick-release tie downs or u-bolts for permanent mounting. Top versatile storage area with foam hand grips. Measures 33" L x 17" W x 8" H. Imported.

DESCRIPTION	PART #
PROSPECTOR FRONT STORAGE TRUNK	3505-0006

NOTE: NEVER EXCEED MANUFACTURERS RECOMMENDED WEIGHT CAPACITY LIMITS.



MUDT10



MUDT10 - CENTER STORAGE COMPARTMENT REMOVED



EXECUTIVE STORAGE TRUNK > \$299.95

Made from easy to clean, high impact resistant polyethylene. Center storage compartment removes and allows more space for relaxing while stopped. Not for use as a seat while riding. UV stabilized. Fits most ATVs. Mounts with U-bolts. Measures 35.5" L x 15.5" W x 15" H. Seat size 15.5" L x 21" W x 3" H. Imported.

DESCRIPTION	PART #
EXECUTIVE STORAGE TRUNK	MUDT10

NOTE: NEVER EXCEED MANUFACTURERS RECOMMENDED WEIGHT CAPACITY LIMITS.



EXPLORER STORAGE TRUNK > \$214.95

Made from easy to clean, high impact-resistant polyethylene. UV stabilized. Large 12" opening will fit most chain saws, helmets etc. Urethane molded back pad. U-bolts for permanent mounting and 6 quick release tie down straps for temporary mounting. Measures 37" L x 23" W x 18" H. Imported.

DESCRIPTION	PART #
EXPLORER STORAGE TRUNK	MUDT30

NOTE: NEVER EXCEED MANUFACTURERS RECOMMENDED WEIGHT CAPACITY LIMITS.



DIPLOMAT STORAGE TRUNK > \$285.95

Made from easy to clean, high impact-resistant polyethylene. UV stabilized. Center area allows more space for relaxing while stopped. Not for use as a seat while riding. Fits most ATVs. Mounts with u-bolts. Measures 42 1/4" L x 25" W x 18" H. Seat size 23.5" L x 15.25" W x 3" H. Imported.

DESCRIPTION	PART #
DIPLOMAT STORAGE TRUNK	3505-0031

NOTE: NEVER EXCEED MANUFACTURERS RECOMMENDED WEIGHT CAPACITY LIMITS.

- PLOWS
- WINCHES
- UTV
- RACKS
- LUGGAGE**
- BODY
- CONTROLS
- ELECTRICAL
- WHEELS & TIRES
- SUSPENSION & DRIVE
- ENGINE
- NRA BY MOOSE
- RIDER
- TOWING
- GARAGE
- PROMO



0530-1009



0530-1299



0530-1005



0530-1265



0530-1002



0530-1008

FRONT BUMPERS > \$11.95-\$215.95

Modern style for the most popular models. Made of powder coated steel. Protect lights against bushes and stones. Mounts to OEM bumper. Made in the USA.

FITS MODEL	PART #
FRONT BUMPERS	
HONDA	
RANCHER 420 07-13	0530-1009
RINCON 650/680 03-13	0530-1005
KAWASAKI	
BRUTE FORCE 650 IRS 07-09	0530-1003
BRUTE FORCE 650 IRS 11	0530-1002
BRUTE FORCE 750 08-11	0530-1002
BRUTE FORCE 750 12-13	0530-1299
POLARIS	
ALL 600, 700, 800 SPORTSMAN 05-10 (ALL EXCEPT X2, TOURING)	0530-1006
SPORTSMAN 850/550 XP (INCLUDES TOURING/X2) 09-13	0530-1265
SUZUKI	
KING QUAD 450/500/700/750 06-13	0530-1008
YAMAHA	
GRIZZLY 550 09-11	0530-1004
GRIZZLY 700 07-13	0530-1004
REPLACEMENT END CAPS (4-PK)	0530-1266



0530-1004



0530-1149



0530-1148



0530-1150



0530-1318



0530-1293



0530-1152



0530-1153



0530-1154

REAR BUMPERS > \$11.95-\$142.95

Modern style for the most popular models. Made of powder coated steel. Mounts to OEM bumper. Made in the USA.

FITS MODEL	PART #
REAR BUMPERS	
HONDA	
RANCHER 420 07-13	0530-1149
RINCON 650/680 03-13	0530-1148
KAWASAKI	
BRUTE FORCE 650 I 06-11	0530-1150
BRUTE FORCE 750 I 08-11	0530-1150
BRUTE FORCE 750 I 12-13	0530-1318
POLARIS	
ALL 500, 600, 700, 800 SPORTSMAN 05-13	0530-1293 ¹
SPORTSMAN 850/550 XP 09-13	0530-1152
SUZUKI	
KING QUAD 450/500/700/750 06-13	0530-1153
YAMAHA	
550 GRIZZLY 09-12	0530-1154
700 GRIZZLY 07-13	0530-1154
REPLACEMENT END CAPS (4-PK)	0530-1266

¹STANDARD BODY ONLY (WILL NOT FIT TOURING, X2, 6X6 OR ATP MODELS)



CV BOOT GUARDS > \$64.95

Tough, lightweight aluminum guards are an inexpensive investment that can pay off in a hurry. Protected and undamaged boots keep lubrication in, water and dirt out. Save costly repairs to CV joints by protecting boots and CV's themselves. Made in the USA.

FITS MODEL	FRONT PART #	REAR PART #
CV BOOT GUARDS		
ARCTIC CAT		
366 4X4	0430-0520	-
650 PROWLER H-1 4X4 06-08	-	0430-0290
700 PROWLER 08-11	-	0430-0290
HONDA		
TRX300 FOURTRAX 4X4 88-00	MUDH03	-
TRX350 RANCHER 4X4 00-06	0430-0127	-
TRX400 FOREMAN S/ES 4X4 95-03	0430-0127	-
TRX400 RANCHER 4X4 (ALL) 04-07	0430-0127	-
TRX420 RANCHER 4X4 07-13	0430-0365	-
TRX450 FOREMAN S/ES 4X4 98-04	0430-0127	-
TRX500 FOREMAN/RUBICON 4X4 (ALL) 05-13	0430-0126	-
TRX500 RUBICON 4X4 01-04	0430-0127	-
TRX650 RINCON 4X4 03-05	0430-0127	-
TRX680 RINCON 06-13	0430-0126	-

LICENSE DECAL KIT > \$7.95

Included white background measures; 4" L x 7 1/2 H". Kits include two sets of black number decals, one set of black letter decals. Purchase M92-21182 or M92-21188 license plate holder kits below to make you legal in most states; please check state and local laws before ordering. Imported.



DESCRIPTION	PART #
LICENSE DECAL KIT	4303-0166

LICENSE PLATE HOLDER > \$11.95

4" x 8" plate designed for decal placement. Made in the USA.



DESCRIPTION	PART #
LICENSE PLATE HOLDER	
BLACK	M92-21182
POLISHED	M92-21188

FITS MODEL	FRONT PART #	REAR PART #
CV BOOT GUARDS (CON'T)		
POLARIS		
250 XPLOER 4X4 00-01	MUDP03	-
300 XPLOER 4X4 96-99	MUDP03	-
325 MAGNUM 4X4 00-01	MUDP03	-
325 XPEDITION 4X4 01	MUDP03	-
330 MAGNUM 4X4 03-04	MUDP03	-
400 XPLOER 4X4 95-02	MUDP03	-
425 XPEDITION 4X4 00-01	MUDP03	-
455 DIESEL 4X4 99-01	MUDP03	-
500 MAGNUM/BIG BOSS 98-01	MUDP03	-
ALL SPORTSMAN MODELS (INCLUDING ATP/X2/XP) 96-12	MUDP03	-
RANGER 500 08	0430-0237	0430-0238
RANGER 700 (XP & CREW) 06-08	0430-0237	0430-0238
SUZUKI		
400 EIGER 4X4 (ALL) 02-07	MUDS04	-
400 KING QUAD 08-12	MUDS04	-
450 KING QUAD 07-09	0430-0366	-
500 KING QUAD 09-13	0430-0366	-
500 QUADMASTER 4X4 00-01	MUDS04	-
500 QUADRUNNER 4X4 98-02	MUDS04	-
500 VINSON 4X4 (ALL) 03-07	MUDS04	-
700 KING QUAD 06-07	0430-0366	-
750 KING QUAD 08-13	0430-0366	-
YAMAHA		
YFM350 BIG BEAR 4X4 99	0430-0520	-
YFM350 BRUIN 4X4 04-06	0430-0520	-
YFM350 GRIZZLY 4X4 (ALL) 07-08	0430-0520	-
YFM350 WOLVERINE 4X4 95-05	0430-0520	-
YFM400 BIG BEAR 4X4 (ALL) 07-08	0430-0520	-
YFM400 GRIZZLY 4X4 07	0430-0520	-
YFM400 KODIAK 4X4 (ALL) 00-05	0430-0520	-
YFM450 GRIZZLY 4X4 07-10	0430-0521	-
YFM450 KODIAK 4X4 03-06	0430-0520	-
YFM450 WOLVERINE 4X4 07-08	0430-0520	-
YFM550 GRIZZLY 09-12	0430-0367	-
YFM660 GRIZZLY 4X4 02-08	0430-0520	-
YFM700 GRIZZLY 4X4 (ALL) 07-13	0430-0367	-
RHINO 450 4X4 06-08	0430-0004	0430-0239
RHINO 660 4X4 04-07	0430-0004	0430-0239
RHINO 700 4X4 08-13	0430-0004	0430-0239



RADIATOR GUARDS > \$43.95

This guard offers more protection and style than stock. Doesn't interfere with air-flow. Made from heavy-duty 5054 aluminum. Made in the USA.

FITS MODEL	PART #
RADIATOR GUARDS	
KAWASAKI	
BRUTE FORCE 650/750 05-13	1904-0075
POLARIS	
SPORTSMAN 500 & UP 04-11	1904-0077
SUZUKI	
KING QUAD 700/750 06-13	1904-0076

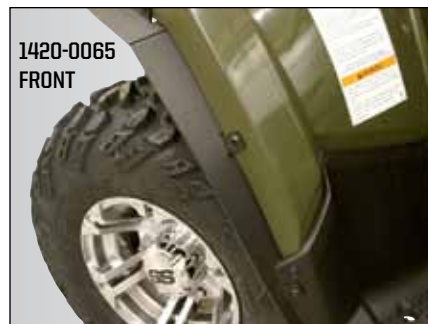

FENDER EXTENSIONS > \$69.95

Made from .187 premium polyethylene material. Adds 2.5" of protection. Includes flares for front and rear fenders. Drilling of fenders required. Mounting hardware included. Made in the USA.

FITS MODEL	PART #
FENDER EXTENSIONS	
HONDA	
TRX650/680 RINCON 02-13	1420-0067
POLARIS	
SPORTSMANS ALL 05-10 (NOT FOR XP OR X2 MODELS)	1420-0065
YAMAHA	
YFM500 GRIZZLY 09-11	1420-0066
YFM700 GRIZZLY 07-11	1420-0066



- PLOWS
- WINCHES
- UTV
- RACKS
- LUGGAGE
- BODY**
- CONTROLS
- ELECTRICAL
- WHEELS & TIRES
- SUSPENSION & DRIVE
- ENGINE
- NRA BY MOOSE
- RIDER
- TOWING
- GARAGE
- PROMO

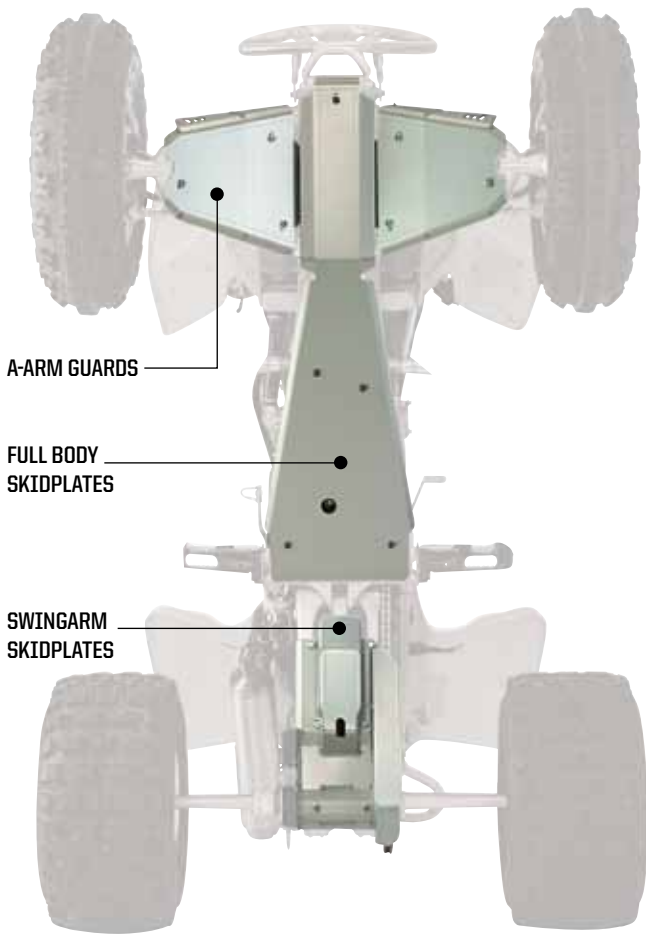

A-ARM GUARDS > \$61.95-\$171.95

Constructed from 3/16" aluminum alloy plate. Helps ATV slide over rocks without damaging the a-arms. All mounting hardware included. Made in the USA.

FULL BODY SKIDPLATES > \$58.95-\$395.95

Heavy-duty aluminum skidplate protects the frame, engine case and undercarriage from rocks and debris. Includes oil drain hole. All mounting hardware included. Made in the USA.

SWINGARM SKIDPLATES > \$42.95-\$178.95

Heavy-duty aluminum skidplate protects your sprocket, swingarm and brake rotor from rocks and other debris. All mounting hardware included. Made in the USA.

FITS MODEL	SWINGARM SKIDPLATE	FULL-BODY SKIDPLATE	A-ARM GUARDS
SKIDPLATES			
CAN-AM			
OUTLANDER 330/400 STD. 03-05	-	-	0430-0218
OUTLANDER 330/400 MAX 03-05	-	-	0430-0218
OUTLANDER 400 STD. 06-10	-	-	0430-0218
OUTLANDER 400 MAX 06-10	-	-	0430-0218
OUTLANDER 500 STD. 06-12 (GEN 1 FRAME)	-	-	0430-0218
OUTLANDER 650 STD. 06-12 (GEN 1 FRAME)	-	-	0430-0218
OUTLANDER 800 STD. 06-12 (GEN 1 FRAME)	-	-	0430-0218
OUTLANDER 500 MAX 06-12 (GEN 1 FRAME)	-	-	0430-0218
OUTLANDER 650 MAX 06-12 (GEN 1 FRAME)	-	-	0430-0218
OUTLANDER 800 MAX 06-12 (GEN 1 FRAME)	-	0506-0250 ²	0430-0218
HONDA			
TRX250 RECON 97-13	M800-09	M900-85	M700-02
RANCHER 350 4X4 00-03	-	-	M700-06
RANCHER 350/400 04-07	-	-	M700-06
TRX400 FOREMAN 98-01	-	0505-0081 ¹	-
TRX420 RANCHER 07-13 2X4	0506-0321	0505-0620	-
TRX420 RANCHER 07-13 4X4	0506-0321	0505-0620	0430-0373
TRX420 RANCHER 09-13 4X4 IRS	-	0506-0523	0430-0545
TRX450 FOREMAN 98-04	-	0505-0081 ¹	-
FOREMAN 500 05-11	0505-0278	0506-0184 ¹	0430-0125
FOREMAN 500 12-13	0505-1196	0506-0692	0430-0125
RUBICON 500 05-13	0505-0278	0506-0185 ¹	0430-0125
RINCON 650 03-05	0505-0428	0505-0083 ¹	-
RINCON 680 06-13	0505-0428	0505-0083 ¹	0430-0244 ³
KAWASAKI			
LAKOTA 300 98-04	M800-21	-	-
PRAIRIE 650 01-03	-	0505-0084	M700-24
BRUTE FORCE 650 05-11 (NOT "I" MODEL)	-	0505-0084	M700-24
BRUTE FORCE 650 I 07-09	-	0506-0156 ¹	0430-0092 ³
BRUTE FORCE 650 I 10-13	-	0506-0383 ²	0430-0092 ³
PRAIRIE 700 04-06	-	0505-0084	M700-24
BRUTE FORCE 750 05-07	-	0506-0156 ¹	0430-0092 ³
BRUTE FORCE 750 08-13	-	0506-0383 ²	0430-0092 ³
POLARIS			
EXPLORER 250 02-04	-	-	M700-50
TRAIL BOSS 325/330 00-04	M800-36	M800-89	M700-50
TRAIL BOSS 325/330 05-06	0505-0393	M800-89	M700-50
RZR 800 08-13 (NOT S MODEL)	-	-	0430-0482 ³
SUZUKI			
OZARK 250 02-13	0505-0091	-	-
KING QUAD 400 08-13	-	0506-0524	M700-33
EIGER 400 02-07	-	0505-0085 ¹	M700-33
KING QUAD 450 07-13	-	0506-0157 ¹	0430-0093 ³
KING QUAD 450 11-13	-	0506-0157 ¹	0430-0609 ³
VINSON 500 02-07	-	0505-0086 ¹	M700-33
KING QUAD 750 09-13	-	0506-0157 ¹	0430-0609 ³
YAMAHA			
GRIZZLY 350 07-12	M800-65	-	M700-72
GRIZZLY 350 07-13 (IRS)	-	0506-0158 ¹	-
BRUIN 350 04-06	M800-65	-	M700-72
GRIZZLY 660 02-08	-	-	M700-18 ³
GRIZZLY 700 07-13	-	0506-0300 ²	0430-0323 ³
RHINO 450/660 04-05	-	-	0430-0095 ³
RHINO 450/660 06-08	-	-	0430-0095 ³
RHINO 700 08-11	-	-	0430-0095 ³

¹ TWO-PIECE DESIGN ² THREE-PIECE DESIGN ³ INCLUDES FRONT & REAR



4510-0324



0521-0875



DUAL SIDE PANELS WITH INSIDE OR OUTSIDE ACCESS

DELUXE CAB ENCLOSURE > \$327.95-\$342.95

Large ultra clear windows. Dual inside roof panels. Dual side panels with inside or outside access. Rugged powder-coated steel tube frame. Fits ATVs with front and rear racks. Not collapsible. Measures 72" L x 38" W x 44" H. Imported.

DESCRIPTION	PART #
BLACK	4510-0324
REALTREE® AP™	0521-0875

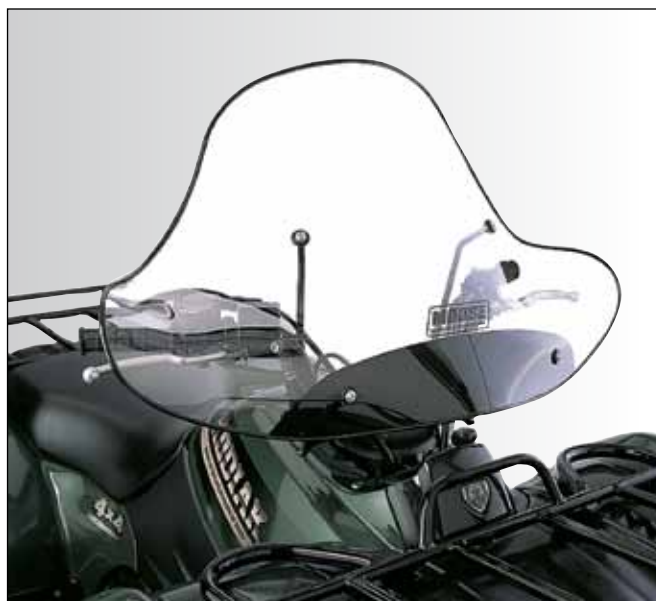

WINDSHIELD > \$29.95-\$99.95

Made from .100" polycarbonate material. Rigid, four point mounting hardware with breakaway design. Quick disconnect handlebar clamps for easy removal. Measures 19" H x 37.5" L. Made in the USA.

FITS MODEL	PART #	FITS WINDSHIELD	PART #
W/ HEADLIGHT CUT OUT	MUDWS10	REPLACEMENT HARDWARE KITS	
NO HEADLIGHT CUT OUT	MUDWS20	MUDWS10	2317-0068
HONDA FOREMAN 450 96-04	MUDWS30	MUDWS20	2317-0068
		MUDWS30	2317-0069



WINDSHIELD > \$99.95

Aggressive new design for added durability and protection. One part number for ATV's with headlight and without headlight. Universal quick release hardware. Made in the USA.

DESCRIPTION	PART #
WINDSHIELD	2317-0163
REPLACEMENT GROMMETS	2317-0120

PLOWS

WINCHES

UTV

RACKS

LUGGAGE

BODY

CONTROLS

ELECTRICAL

WHEELS & TIRES

SUSPENSION & DRIVE

ENGINE

NRA BY MOOSE

RIDER

TOWING

GARAGE

PROMO



MOSSY OAK BREAK-UP®



BLACK



MOSSY OAK BREAK-UP®



BLACK

CORDURA SEAT COVERS > \$36.95-\$39.95

Fits over the existing seat cover. No stapling necessary; elastic shock cord sewn into the bottom that holds the cover in place. Weather-resistant and can be machine washed. Made in the USA.

FITS MODEL	MOSSY OAK BREAK-UP® PART #	BLACK PART #
CORDURA SEAT COVERS		
ARCTIC CAT		
99-01 ALL 4X4 MODELS ONLY	MUD001	MUD101
02-04 ALL 4X4 MODELS ONLY (NO TBX MODELS)	0821-0089	0821-0194
HONDA		
TRX250 RECON 97-04	MUD020	MUD120
TRX250 RECON 05-13	0821-0330	0821-0331
TRX300 4X4 88-95	MUD002	MUD102
TRX300 2X4/4X4 96-00	MUD002	MUD102
TRX350 RANCHER 2X4/4X4 00-03	MUD012	MUD112
TRX350/400 RANCHER 4X4/2X4 04-07	0821-0090	0821-0195
TRX420 RANCHER 07-13	0821-0718	0821-0717
TRX400 4X4 FOREMAN 98-04	MUD003	MUD103
TRX450S/ES 4X4 FOREMAN 98-04	MUD003	MUD103
TRX500 FOREMAN 05-11	0821-0328	0821-0329
TRX500 RUBICON 00-04	MUD013	MUD113
TRX500 RUBICON 05-13	0821-0332	0821-0333
TRX650 RINCON 03-05	MUD021	MUD121
TRX680 RINCON 06-13	MUD021	MUD121
KAWASAKI		
KVF300/400 PRAIRIE 97-01	MUD004	MUD104
BRUTE FORCE 750 & 650I 05-13	0821-0334	0821-0335
POLARIS		
250 TRAIL BOSS 96-99	MUD011	-
300 XPLORER 98-02	MUD005	MUD105
300 XPRESS 98-02	MUD005	MUD105
325 MAGNUM 00-02	MUD005	MUD105
325 TRAIL BOSS 00-02	MUD011	-
325 XPEDITION 01-02	MUD005	MUD105
335 SPORTSMAN 98-03	MUD005	MUD105
400 SPORTSMAN 96	MUD011	-
400 SPORTSMAN 04	0821-0091	-
400 XPLORER 99-02	MUD005	MUD105
425 XPEDITION 00-02	MUD005	MUD105
425 2X4/4X4 MAGNUM 96-98	MUD005	MUD105
500 SPORTSMAN 98-03	MUD005	MUD105
500 SPORTSMAN HD 04	0821-0091	-
500 MAGNUM 99-02	MUD005	MUD105
600 SPORTSMAN TWIN 04	0821-0091	-
700 SPORTSMAN 02-03	MUD005	MUD105
700 SPORTSMAN TWIN EFI 04	0821-0091	-
DIESEL	MUD005	MUD105
400/500/600/700/800 SPORTSMAN 05-10	0821-0336	0821-0337
SUZUKI		
LT-300 KING QUAD 99-03	MUD008	MUD108
KING QUAD 450 & 500 07-13	0821-0346	-
LT-F500 97-02	MUD006	MUD106
LT-A500F QUADMASTER 00-02	MUD006	MUD106
LT-A500F VINSOW 500 02-06	MUD016	MUD116
KING QUAD 700 05-08	0821-0346	-
KING QUAD 750 09-13	0821-0346	-
YAMAHA		
YFM350 BIG BEAR 94-99	MUD009	MUD109
YFM350 BRUIN 04-06	-	0821-0345
YFM350 GRIZZLY 07-11	-	0821-0345
YFM400 BIG BEAR 00-11	MUD015	MUD115
YFM400 KODIAK 00-04	MUD014	MUD114
YFM450 KODIAK 03-04	MUD014	MUD114
YFM600 GRIZZLY 98-01	MUD007	MUD107
YFM660 GRIZZLY 02-07	MUD017	MUD117
YFM550 & YFM700 GRIZZLY 07-13	0821-0720	0821-0719

NEOPRENE SEAT COVERS > \$58.95-\$61.95

3.0mm black neoprene insert provides comfort and a waterproof barrier between the rider and the seat. Conforms to the seat for a tight custom fit that protects the seat from damage. Heavy elastic around edge of seat cover makes for easy installation with no tools. Made in the USA.

FITS MODEL	MOSSY OAK BREAK-UP® PART #	BLACK PART #
NEOPRENE SEAT COVERS		
HONDA		
TRX300 4X4/2X4 88-00	-	0821-0691
TRX350 RANCHER 00-03	-	0821-0696
TRX350/400 RANCHER 04-06	0821-0684	0821-0703
TRX400 FOREMAN 98-04	0821-0673	0821-0692
TRX420 RANCHER 07-13	-	0821-0723
TRX450S/ES FOREMAN 98-04	0821-0673	0821-0692
TRX500 FOREMAN 05-11	0821-0685	-
TRX500 RUBICON 00-04	-	0821-0697
TRX500 RUBICON 05-13	-	0821-0706
POLARIS		
400/500/600/700/800 SPORTSMAN 05-09	-	0821-0708
YAMAHA		
YFM400 KODIAK 00-04	0821-0679	0821-0698
YFM450 KODIAK 03-04	-	0821-0698



SEAT FOAM > \$58.95

Replace that torn up seat! OEM-style seat foam at a fraction of the cost. Uses stock base plate. Made in the USA.

FITS MODEL	PART #
SEAT FOAM	
HONDA	
TRX300 FW 88-00	0812-0018
TRX350/400 RANCHER 00-03	0812-0019
TRX450 FW FOREMAN 98-04	0812-0020
POLARIS	
325 MAGNUM 00-02	0812-0022
330 MAGNUM 03-06	0812-0022
330 TRAILBOSS 02-09	0812-0022
335 SPORTSMAN 99-00	0812-0022
400 SPORTSMAN 01-04	0812-0022
500 MAGNUM 99-02	0812-0022
500 SPORTSMAN 96-04	0812-0022
600 SPORTSMAN 03-04	0812-0022
700 SPORTSMAN 02-04	0812-0022
YAMAHA	
YFM250 BIG BEAR 07-09	0812-0023
YFM250 BRUIN 05-06	0812-0023
YFM350 BRUIN 04-06	0812-0023
YFM350 GRIZZLY 07-11	0812-0023
YFM400 KODIAK 00-06	0812-0023
YFM450 KODIAK 00-06	0812-0023
YFM660 GRIZZLY 02-08	0812-0021

OEM REPLACEMENT SEAT COVERS > \$43.95

Heavy-duty, UV resistant, black marine grade vinyl. Double stitched for durability. Must remove stock seat cover to staple on new cover. Made in the USA.

FITS MODEL	PART #
OEM REPLACEMENT SEAT COVERS	
ARCTIC CAT	
400 06-10	0821-1183
450 11-12	0821-1183
500 05-08	0821-1183
550 09-13	0821-1183
650 05-10	0821-1183
700 06-13	0821-1183
1000 08-13	0821-1183
CAN-AM	
OUTLANDER 500 07-13	0821-1406
OUTLANDER 650 07-13	0821-1406
OUTLANDER 800 06-13	0821-1406
HONDA	
TRX90 93-05	0821-1512
TRX200 91-97	0821-1414
TRX250 RECON 97-04	0821-1186
TRX250 RECON 05-13	0821-1004
TRX300 FW 88-00	0821-1008
TRX350/400 RANCHER 00-03	0821-1009
TRX350/400 RANCHER 04-07	0821-1010
TRX400 FW FOREMAN 95-01	0821-1011
TRX420 RANCHER 07-13	0821-1013
TRX450 FW FOREMAN 98-04	0821-1014
TRX500 FOREMAN 05-11	0821-1016
TRX500 FOREMAN 12-13	0821-1517
TRX500 FW RUBICON 01-04	0821-1015
TRX500 FW RUBICON 05-13	0821-1016
TRX650 RINCON 03-06	0821-1017
TRX680 RINCON 06-13	0821-1017
KAWASAKI	
KLF220 BAYOU 88-01	0821-1184
KLF250 BAYOU 02-11	0821-1184
KLF300 BAYOU 4X4 86-88	0821-1408
KLF300 BAYOU 4X4 89-04	0821-1178
KLF300 BAYOU 2X4 89-04	0821-1408
KEF300 LAKOTA 95-04	0821-1415
KVF300 PRAIRIE 99-02	0821-1127
KVF360 PRAIRIE 02-13	0821-1416
KLF400 BAYOU 93-99	0821-1178
KVF400 PRAIRIE 97-02	0821-1127
KVF650I BRUTE FORCE 05-13	0821-0998
KVF650 BRUTE FORCE 06-11	0821-0997
KVF650 PRAIRIE 02-03	0821-0997
KVF700 PRAIRIE 04-06	0821-0997
KVF750 BRUTE FORCE 05-13	0821-0998
POLARIS	
325 MAGNUM 00-02	0821-1001
325 TRAIL BOSS 94-97	0821-1409
330 MAGNUM 03-06	0821-1001
330 TRAIL BOSS 02-09	0821-1001
335 SPORTSMAN 99-00	0821-1001
400 SPORTSMAN 94-97	0821-1409
400 SPORTSMAN 01-04	0821-1001
400 SPORTSMAN 05	0821-1002
400 SPORTSMAN 11-13	0821-1002
450 SPORTSMAN 06-07	0821-1002
500 MAGNUM 99-02	0821-1001
500 SPORTSMAN 96-04	0821-1001
500 SPORTSMAN 05-13	0821-1002
550 XP 09-13	0821-1513
600 SPORTSMAN 03-04	0821-1001
600 SPORTSMAN 05	0821-1002
700 SPORTSMAN 02-04	0821-1001



FITS MODEL	PART #
OEM REPLACEMENT SEAT COVERS (CON'T)	
POLARIS (CON'T)	
700 SPORTSMAN 05-07	0821-1002
800 SPORTSMAN 05-13	0821-1002
850 XP 09-13	0821-1513
SUZUKI	
LTF160 89-01	0821-1417
LTF250 OZARK 02-13	0821-1179
LTF250 QUAD RUNNER 87-89	0821-1128
LTF250 QUAD RUNNER 99-02	0821-1129
LTF300 KING QUAD 91-98	0821-1128
LTF300 KING QUAD 99-02	0821-1129
LTF400 EIGER 02-07	0821-1000
LTA400 KING QUAD 08-11	0821-1514
LTA450 KING QUAD 07-09	0821-0999
LTA500 KING QUAD 09-13	0821-0999
LTF500 QUADRUNNER 98-02	0821-1180
VINSON 500 02-07	0821-1185
LTA700 KING QUAD 05-07	0821-0999
LTA750 KING QUAD 08-13	0821-0999
YAMAHA	
YFM125 GRIZZLY 04-13	0821-1515
YFM250 BEAR TRACKER 99-04	0821-1418
YFB250 TIMBERWOLF 92-01	0821-1019
YFM250 BIG BEAR 07-09	0821-1020
YFM250 BRUIN 05-06	0821-1020
YFM350 BRUIN 04-06	0821-1020
YFM350 GRIZZLY 07-13	0821-1020
YFM350 BIG BEAR 87-99	0821-1130
YFM400 BIG BEAR 00-06	0821-1023
YFM400 BIG BEAR 07-12	0821-1024
YFM400 GRIZZLY 07-08	0821-1020
YFM400 KODIAK 93-95	0821-1420
YFM400 KODIAK 96-99	0821-1410
YFM400 KODIAK 00-06	0821-1020
YFM450 GRIZZLY 07-13	0821-1020
YFM450 KODIAK 00-06	0821-1020
YFM550 GRIZZLY 09-13	0821-1025
YFM660 GRIZZLY 02-08	0821-1026
YFM600 GRIZZLY 97-01	0821-1131
YFM700 GRIZZLY 07-13	0821-1025



INTERNAL SEAT HEATER > \$11.95-\$48.95

Installs under OEM vinyl by removing the seat staples along the back of the OEM seat. Warms up fast and is very flexible. 20 watts of power. Plugs into the 4 zone controller kits, 0631-0014, 0631-0015, or 0631-0016 that have 5 levels of heat. Switch included. Made in the USA.

DESCRIPTION	PART #
INTERNAL SEAT HEATER	0821-0725

PLOWS
WINCHES
UTV
RACKS
LUGGAGE
BODY
CONTROLS
ELECTRICAL
WHEELS & TIRES
SUSPENSION & DRIVE
ENGINE
NRA BY MOOSE
RIDER
TOWING
GARAGE
PROMO

**DURA COVER** > \$89.95-\$111.95

Made of tough 600-denier water-resistant, vinyl backed UV treated polyester. Will not fade, shrink, stretch or mildew. Double stitched hems with heavy-duty elastic shock cord at the hem. Tie-down loops sewn into the hem. Washable with mild soap and water. Not for trailering. Storage bag included. Refer to cover sizing chart at bottom of page. Imported.

DESCRIPTION	PART #
L COVER	4002-0052
XL COVER	4002-0053
XXL COVER	4002-0054

**OZARK COVER** > \$65.95-\$89.95

Made from 210-denier urethane-coated nylon. Will not fade, shrink, stretch or mildew. Double stitched hems with heavy-duty elastic shock cord at the hem. Tie-down loops sewn into the hem. Washable with mild soap and water. Not for trailering. Storage bag included. Refer to cover sizing chart at bottom of page. Imported.

DESCRIPTION	PART #
L COVER	4002-0049
XL COVER	4002-0050
XXL COVER	4002-0051

COVER SIZING CHART

L SIZES			
OVERALL LENGTH: 75"	FRONT WIDTH: 52"	CENTER WIDTH: 33"	
REAR WIDTH: 48"	FRONT HEIGHT: 27"	CENTER HEIGHT: 40"	REAR HEIGHT: 34"
XL SIZES			
OVERALL LENGTH: 90"	FRONT WIDTH: 52"	CENTER WIDTH: 33"	
REAR WIDTH: 48"	FRONT HEIGHT: 27"	CENTER HEIGHT: 40"	REAR HEIGHT: 34"
XXL SIZES			
OVERALL LENGTH: 112"	FRONT WIDTH: 52"	CENTER WIDTH: 36"	
REAR WIDTH: 53"	FRONT HEIGHT: 44"	CENTER HEIGHT: 52"	REAR HEIGHT: 52"



TRAILERABLE COVER > \$92.95-\$121.95

Heavy-duty nylon straps hold the cover on the ATV. 6 tie-down locations allow for extra security. Made of tough 600-denier water-resistant, vinyl backed UV treated polyester. Will not fade, shrink, stretch or mildew. Double stitched seams with heavy-duty elastic shock cord at the hem. Washable with mild soap and water. Storage bag included. Refer to cover sizing chart on opposite page. Imported.

DESCRIPTION	PART #
L COVER	4002-0055
XL COVER	4002-0056
XXL COVER	4002-0057



FENDER COVER KITS > \$144.95-\$188.95

Mossy Oak Break-Up® fender kits are made of 420 denier urethane coated polyester. Water-repellent so mud can be sprayed right off. Easy installation with plastic clips and no snaps. Made in the USA.

FITS MODEL	PART #
CAMO FENDER COVER KITS	
HONDA	
TRX300 2X4/4X4 96-00	MUDFC-09
TRX350/400 RANCHER 4X4/2X4 04-06	1404-0004
TRX400 4X4 FOREMAN 98-04	MUDFC-02
TRX420 RANCHER 07-12	1404-0228
TRX450S/ES 4X4 FOREMAN 98-04	MUDFC-02
TRX500 FOREMAN 05-11	1404-0080
TRX500 RUBICON 05-12	1404-0082
TRX650 RINCON 03-05	MUDFC22
TRX680 RINCON 06-13	MUDFC22

FITS MODEL	PART #
CAMO FENDER COVER KITS (CON'T)	
POLARIS	
300 XPLORESR 98-02	MUDFC-04
300 XPRESS 98-02	MUDFC-04
325 XPEDITION 01-02 (NO POD COVER)	MUDFC-04
325 MAGNUM 00-02	MUDFC-04
330 MAGNUM 04-05	MUDFC-04
335 SPORTSMAN 98-03	MUDFC-04
400 SPORTSMAN 05-09	1404-0084
400 XPLORESR 99-02	MUDFC-04
425 XPEDITION 00-02 (NO POD COVER)	MUDFC-04
450 SPORTSMAN 06-07	1404-0084
500 SPORTSMAN 98-03	MUDFC-04
500 MAGNUM 99-02	MUDFC-04
500 SPORTSMAN 05-09	1404-0084
600 SPORTSMAN 05-09	1404-0084
700 SPORTSMAN 02-03	MUDFC-04
700 SPORTSMAN 05-09	1404-0084
800 SPORTSMAN 05-09	1404-0084
DIESEL 99-00	MUDFC-04
SUZUKI	
KING QUAD 450 & 500 07-13	1404-0091
KING QUAD 700 05-09	1404-0091
KING QUAD 750 09-13	1404-0091
YAMAHA	
YFM400 BIG BEAR 00-11	MUDFC-12
YFM400 KODIAK 00-04	MUDFC-13
YFM450 KODIAK 03-04	MUDFC-13
YFM700 & YFM550 GRIZZLY 07-12	1404-0229

- PLOWS
- WINCHES
- UTV
- RACKS
- LUGGAGE
- BODY**
- CONTROLS
- ELECTRICAL
- WHEELS & TIRES
- SUSPENSION & DRIVE
- ENGINE
- NRA BY MOOSE
- RIDER
- TOWING
- GARAGE
- PROMO



HANDGUARDS > \$59.95-\$79.95

Available for all of your favorite models. Contoured for a custom look. Mount to handlebars. Sold in pairs. Made in the USA.

FITS MODEL	COLOR	PART #
HANDGUARDS		
HONDA		
TRX400AT RANCHER 04-08	BLACK	0635-0074
TRX500 RUBICON 01-11	RED	0635-0075
TRX650 RINCON 03-05	OLIVE	0635-0076
TRX680 RINCON 06-11	STEALTH BLACK	0635-0930
TRX400/450 S/ES FOREMAN 95-04	BLACK	MHG477BK
	OLIVE	MHG477OG
TRX500 FOREMAN 04-11	BLACK	0635-0195
TRX420 EFI RANCHER 07-12	RED	0635-0196
TRX420 AT RANCHER 09-12	OLIVE	0635-0197
TRX500ES/FM FOREMAN 4X4 12	BLACK	0635-0895
	RED	0635-0896
KAWASAKI		
KVF360 PRAIRIE 4X4 03-12	BLACK	0635-0045
KVF700 PRAIRIE 4X4 04-06	RED	0635-0046
KVF650 BRUTE FORCE 4X4/1 05-12	OLIVE	0635-0047
KVF750 BRUTE FORCE 05-12	STEALTH BLACK	0635-0933
POLARIS		
ALL 01-04 (WITH PLASTIC THROTTLE) (MODELS WITH BLACK MASTER CYLINDER HAVING LEVEL WINDOW IN TOP CAP) (NO 6X6, PREDATOR, 50CC OR 90CC)	BLACK	MHG504BK
SUZUKI		
LTZ250 QUADSPORT 03-09	BLACK	MHG478BK
LTZ250 OZARK 03-06	STEALTH BLACK	0635-0934
LT400 EIGER 02-07		
LT400 KING QUAD 08-11		
LT450 KING QUAD 07-10		
LT500 VINSON 02-07		
LT500 KING QUAD 09-12		
LT700 KING QUAD 05-07		
LT700 TWIN PEAKS 04-05		
LT750 KING QUAD 08-12		
YAMAHA		
YFM250 BEARTRACKER 03-04	BLACK	MHG506BK
YFM250 BRUIN 05-06	RED	MHG506R
YFM350 BRUIN 2X4/4X4 04-06	OLIVE	MHG506OG
YFM350 GRIZZLY 07-11	STEALTH BLACK	0635-0935
YFM350 BIG BEAR 2X4 96-99		
YFM350 BIG BEAR 4X4 87-99		
YFM400 KODIAK 93-99		
YFM400 KODIAK 2X4 03-04		
YFM400 GRIZZLY 07-10		
YFM400 BIG BEAR 2X4 03-05		
YFM400 BIG BEAR 4X4 02-12		
YFM400 KODIAK 4X4 02-06		
YFM600 GRIZZLY 98-01		
YFM660 GRIZZLY 02-08		
YFM550 GRIZZLY 09-13	BLACK	0635-0544
YFM700 GRIZZLY 07-3	RED	0635-0545
	STEALTH BLACK	0635-0936



BLACK



MOSSY OAK BREAK-UP®

FOAM HANDGUARDS > \$24.95

Outer shell is made from heavy-duty 500 denier nylon with 1/2" closed cell foam to keep cold, wind and debris at bay. Cinch strap type mounting provides a universal fit for nearly any model of ATV. Twin gromets on the outside of each guard enable the rider to attach cable ties for a more rigid mount. Imported.

DESCRIPTION	PART #
BLACK	0635-0760
MOSSY OAK BREAK-UP®	0635-0761



PAWS GAUNTLETS > \$18.95-\$22.95

Heavy cordura® outer shell with fleece lining helps keep your hands warm. Designed to allow more room for controls and installs easily. Hook-and-loop type fastener that seals around the handlebars. Imported.

DESCRIPTION	PART #
MOSSY OAK BREAK-UP®	0635-0915
REALTREE AP™	0635-0916
BLACK	0635-0917



CLEARVIEW ATV MIRROR W/ VIBRATION ISOLATOR > \$38.95
 Panoramic perspective for less visual distortion. Built-in vibration isolating attachment. Rubber cushioned frame eliminates mirror shake. The spring tension ball mount rotates 360 degrees and tilts 15 degrees for custom positioning. Fast, simple installation. Mounts to the left or right side. Fits tubes up to a 1" diameter. Imported.

DESCRIPTION	PART #
CLEARVIEW ATV MIRROR	0640-0524



THUMB ASSIST > \$23.95
 Bolt-on thumb throttle extender attaches to all models of ATV's. The extender helps to relieve hand fatigue and can adjust to fit various hand sizes for a more comfortable ride. Made from stainless steel with a soft rubber coating. Imported.

DESCRIPTION	PART #
THUMB ASSIST	0632-0459



OEM REPLACEMENT HANDLEBARS > \$34.95
 Avoid paying OEM cost for replacement handlebars. Available in OEM bends. 7/8" diameter and made from .083 steel tubing. Made in the USA.

DESCRIPTION	PART #
HONDA	
TRX300 2X4/4X4 88-93	0601-0696 ¹
TRX400 FOREMAN 4X4 95-98	0601-0696 ¹
TRX500 FOREMAN RUBICON 01-03	0601-0696 ¹
TRX650/680 RINCON 03-11	0601-0696 ¹
POLARIS	
SPORTSMAN 96-10 (ALL)	0601-0695

¹ DOESN'T INCLUDE BRACKET FOR CHOKE



FOAM GRIPS > \$6.95
 Soft closed cell foam grips. Fits 7/8" bars with thumb throttles. 5" long; end caps included. Sold in pairs. Made in the USA.

DESCRIPTION	PART #
FOAM GRIPS	0630-0699



LOCK-ON GRIP SYSTEM > \$23.95
 No more using glue, paint thinner, or safety wire to keep your grips from twisting or slipping. Lock-on grips provide slip-free performance right out of the box. Revolutionary system survives the most severe weather. Installation and removal is easy and will not destroy your grips. Grips slide effortlessly on and off your bars and are locked into place with a few turns of a wrench. Includes removable end plugs for added protection against "grip blowout." Compatible with the ODI lock-on grip system. Grip length is 120mm. Made in the USA.

DESCRIPTION	PART #
LOCK-ON GRIP SYSTEM	0630-0979



STEALTH GRIPS > \$7.95
 Custom half-waffle pattern with high-traction chevrons. Wire grooves don't interfere with grip comfort. Special made compound feels soft, but wears like a harder compound. Comes with 7/8" inner diameter and small flanges for thumb throttles. Made in the USA.

DESCRIPTION	PART #
BLACK	0630-0395
GRAY	0630-0396
RED	0630-0397
ORANGE	0630-0423
BLUE	0630-0398

PLOWS

WINCHES

UTV

RACKS

LUGGAGE

BODY

CONTROLS

ELECTRICAL

WHEELS & TIRES

SUSPENSION & DRIVE

ENGINE

NRA BY MOOSE

RIDER

TOWING

GARAGE

PROMO



COMPLETE WINTER PACK PLUS > \$94.95-\$158.95
 Complete kit includes: heated grips, thumb warmer, 4 zone controller, 1 DC plug, and hardware. Grips to be installed with WD-40® (WD-40® not included). Apply WD-40® to the inside of the grip and a chemical reaction occurs with a special coating applied to the interior tube. Made in the USA.

DESCRIPTION	PART #
COMPLETE WINTER PACK PLUS	0631-0016
REPLACEMENT CONTROLLER	0631-0023



COMPLETE WINTER PACK > \$69.95-\$122.95
 Kit comes complete with heated grips and thumb warmer. Mountable controller regulates heat between the thumb and grips. Dual zone temperature control, 5 levels of heat, LED light indicators, 2 hour auto shut off and multiple mounting options. Fits any 7/8" bar. Independent control between grips and thumb warmer. No adhesive required. Maximum 20 watts @ 14 volts. Made in the USA.

DESCRIPTION	PART #
COMPLETE WINTER PACK	0631-0002
REPLACEMENT CONTROLLER	0631-0021



HAND WARMER KIT > \$6.95-\$38.95
 Effective at keeping hands warm. Simple operation hi/low/off switch. Works on most models. Made in the USA.

DESCRIPTION	PART #
HAND WARMER KIT	M92-21007 ¹
REPLACEMENT PARTS	
HI/LOW/OFF SWITCH- METAL	M92-22004
ELEMENT	M92-21014

¹ NOT FOR BOMBARDIER ATV'S



COMPLETE WINTER PACK BASIC > \$94.95-\$158.95
 Kit includes heated grips, thumb warmer, 4-zone controller, and 1 DC connector, controller with memory, 2 part adhesive and hardware. Made in the USA.

DESCRIPTION	PART #
COMPLETE WINTER PACK BASIC	0631-0014
REPLACEMENT CONTROLLER	0631-0023



NO ADHESIVE HEATED GRIPS > \$57.95
 Fits all 7/8" handlebars. No adhesive required; pushes on and stays on. Increased rider comfort with even and consistent heat distribution from unique flex circuit technology. 20 watts of heating power. Great feel and handling from the special molded rubber grips. Made in the USA.

DESCRIPTION	PART #
NO ADHESIVE HEATED GRIPS	0631-0003
REPLACEMENT SWITCH	0631-0009
REPLACEMENT GRIP	0631-0019



COMPLETE WINTER PACK > \$94.95-\$125.95
 Kit includes 2 heating elements (Use your own grips), hardware, 4 zone controller and 1 DC plug. Heaters wrap around your handle bar and stay on with adhesive that is already on the heater. Simply pull off the protective cover, wrap on your handlebar, and push on the grips of your choice. Made in the USA.

DESCRIPTION	PART #
COMPLETE WINTER PACK	0631-0015
REPLACEMENT CONTROLLER	0631-0023



THUMB WARMER KIT > \$6.95-\$34.95
 Keeps thumb warm in cold weather. Simple operation hi/low/off switch. Installation is easy, just peel and press. Works on all models. Made in the USA.

DESCRIPTION	PART #
THUMB WARMER KIT	M92-21008
REPLACEMENT PARTS	
ELEMENT FOR PART# M92-21008	M92-21009
HI/LOW/OFF SWITCH	M92-22004



HAND SHIFTERS > \$25.95
 Great on all models. Universal models mount to most ATV foot shift levers. Sturdy construction with strong mountings. Made in the USA.

DESCRIPTION	PART #
UNIVERSAL, 15" HANDLE	MUD4632
UNIVERSAL, 22" HANDLE	MUD4620
YAMAHA YFM350 BIG BEAR 87-09, 20" HANDLE	MUD4054
SUZUKI LT400 EIGER, LT250 KING QUAD, LT-F500 QUADRUNNER, 20" HANDLE	MUD4698

STEEL FOLDING SHIFT LEVERS > \$32.95

Folding tips prevent snagging and withstand repeated bends, no breaking. Hardened splines. Made in the USA.



FITS MODEL	PART #
STEEL FOLDING SHIFT LEVERS	
HONDA	
TRX250 RECON 97-11	MAH6
TRX300 2X4/4X4 88-99	MAH2
TRX350 RANCHER 01-03	MAH7
TRX400 FOREMAN 95-04	MAH6
TRX450S FOREMAN 98-04	MAH6
KAWASAKI	
KLF220 BAYOU 88-11	MAK1

DRINK CUP HOLDER > \$38.95

Securely attaches to your ATV's rack or handlebars. Self-levels to ensure your drink won't spill. Contents not included. Imported.



DESCRIPTION	PART #
DRINK CUP HOLDER	3550-0031



DELUXE GPS/PHONE HOLDER > \$54.95

Designed to hold handheld electronic devices such as cell phones, GPS systems, two-way radios, etc. Mounts to handlebars for easy access. Allows for unlimited adjustments. Marine-grade aluminum with a black, powder-coated finish. Imported.

DESCRIPTION	PART #
DELUXE GPS/PHONE HOLDER	M92-21130



FINGER GRIP ATV/UTV COMMUNICATION HOLDER > \$51.95

Quickly and easily mounts to a wide variety of hand-held devices. Several arm lengths are included. Mounts to any round rail from .75" to 3". Patented rubber ball and socket provides shock and vibration dampening. Imported.

DESCRIPTION	PART #
FINGER GRIP ATV/UTV COMMUNICATION HOLDER	4402-0063

USING SHORT ARM SIDE CLAMPS		
MAXIMUM DEPTH: 0.75"	MINIMUM WIDTH: 1.25"	MAXIMUM WIDTH: 3.0"
USING MEDIUM ARM SIDE CLAMPS		
MAXIMUM DEPTH: 1.25"	MINIMUM WIDTH: 1.5"	MAXIMUM WIDTH: 3.0"
USING LONG ARM SIDE CLAMPS		
MAXIMUM DEPTH: 1.6"	MINIMUM WIDTH: 2.25"	MAXIMUM WIDTH: 3.5"



ATV/UTV AQUA BOX > \$54.95-\$81.95

Touch through lens to operate buttons. Works great for MP3's. Padded foam interior to provide additional shock and vibration protection. Imported.

DESCRIPTION	INTERNAL DIMENSIONS	PART #
SMALL	2.4" W X 4.6" H X 1.1" D	4402-0045
MEDIUM	2.8" W X 5.7" H X 1.1" D	4402-0046
LARGE/UTV	3.25" W X 8.25" H X 2.81" D	4402-0062



PLOW LIGHT MOUNT KIT > \$2.95-\$38.95

Base made from steel. Light support arms made from 7-gauge steel. Great for night time, or early morning plowing. Attaches to front rack of ATV. Uses 1 1/8" u-bolts. Uses MDL01 light kit (see below description). Made in the USA.

DESCRIPTION	PART #
PLOW LIGHT MOUNT KIT	2001-0116
HALOGEN LIGHT KIT	MDL01
REPLACEMENT BULB	MDL01R
REPLACEMENT LENS	MDL01L



WORK LIGHT > \$2.95-\$18.95

12-volt halogen light measures 3 15/16" x 3 1/8". Shock mounted clamp with rubber inserts allows fitment for a bar up to 1" in diameter. Imported.

DESCRIPTION	PART #
WORK LIGHT	MDL02
REPLACEMENT BULB	MDL01R
REPLACEMENT LENS	MDL01L



HALOGEN LIGHT KIT > \$2.95-\$33.95

120,000 candlepower halogen lights. Designed for ATV's and measure 4" W x 3" H. Complete kit includes 2 lights, wiring and hardware and it's simple design allows for attachment on a variety of areas on your ATV. Imported.

DESCRIPTION	PART #
HALOGEN LIGHT KIT	MDL01
REPLACEMENT BULB	MDL01R
REPLACEMENT LENS	MDL01L



WIRELESS HOUR METER > \$54.95

The most advanced, accurate and reliable hour meter made and the quickest to install. Automatically starts/stops from the running of your engine by sensing the resonance of the motor. No wiring required - just peel and stick. Includes resettable trip and total hours accumulated modes. Waterproof and shock resistant with a built in battery lifespan of 5-7 years. Comes with a log book to track the service life, oil changes, valve adjustments, spark plugs and settings, etc. Records and displays up to 9,999.9 hours. Push button to display data when engine is not running. Works on motorcycle, ATV/UTV or PWC automatically. 2 or 4 stroke. Made with solid-state electronics, modern LCD and ROHS compliant components. CE certified and IP-68 rating. Made in the USA.

DESCRIPTION	PART #
WIRELESS HOUR METER	2212-0426



HOUR METER & HOUR/TACH METER > \$34.95

Keeps track of times for your oil changes, valve adjustments, spark plugs, etc. Usable with any gas engine. Records/displays up to 9,999.9 hours. Peel and stick or can be permanently mounted. Connect to spark plug wire. Hours automatically roll over. Log book included. Imported.

DESCRIPTION	PART #
HOUR METER	2212-0026
HOUR/TACH METER	2212-0405



RESETTABLE HOUR/TACH METER > \$39.95

Three resettable service alarms which include, "clean air filter", "change oil" and "valve service." Time mode allows you to record running time periods, but easily resets with the touch of a button. No power or ground wires required. Larger display makes it easier to read. Works on all gasoline engines. Includes double-sided tape, screws and fasteners. Log book included. Imported.

DESCRIPTION	PART #
RESETTABLE HOUR METER	2212-0406

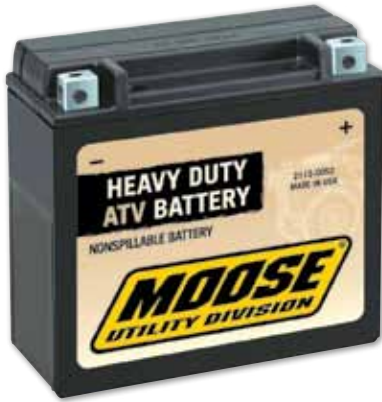

FACTORY-ACTIVATED AGM MAINTENANCE-FREE BATTERIES > \$39.95-\$99.95

Pre-filled, sealed, charged and ready to go! Spill-proof design. Sulfation retardant. Advanced lead-calcium technology. Exceptional resistance to vibration. Vast impact in extreme weather conditions. Imported.

PART #	EQUIVALENT YUASA PART #
2113-0045	YTX4L-BS
2113-0046	YTX5L-BS
2113-0047	YTX7A-BS
2113-0048	YTX9-BS
2113-0049	YTX12-BS
2113-0050	YTX14-BS
2113-0051	YTX14AH-BS
2113-0052	YTX20HLBS

FITS MODEL	PART #
FACTORY-ACTIVATED AGM BATTERIES	
ARCTIC CAT	
50 (ALL)	2113-0046
90 (ALL)	2113-0045
400/500 (ALL EXCEPT DVX)	2113-0051 ¹
650 04-06	2113-0051 ¹
CAN-AM	
200 RALLY 03-06	2113-0051 ¹
400 OUTLANDER XT, MAX 04-05	2113-0052 ²
660 OUTLANDER 06	2113-0052 ²
800 OUTLANDER EFI RENEGADE 06-07	2113-0052 ²
E-TON	
AXL/NXL/RXL/TXL 99-03	2113-0045
DXL90 SIERRA 00-03	2113-0046
AXL/NXL/RXL/TXL90 99-03	2113-0045
CXL/YXL150 YUKON 00-03	2113-0048
ALL MODELS 04-05	2113-0046
HONDA	
TRX90 06-08	2113-0046
TRX125 FOURTRAX 87-88	2113-0048
TRX200 84	2113-0051 ¹
TRX200 FOURTRAX 90-91	2113-0049
TRX200D II FOURTRAX 91-96	2113-0049
TRX200SX FOURTRAX 86-88	2113-0049
TRX250 FOURTRAX 85-87	2113-0049
TRX250 RECON 97-07	2113-0049
TRX300 FOURTRAX 92-00	2113-0050
TRX300FW FOURTRAX 4X4 88-00	2113-0050
TRX350 RANCHER 00-06	2113-0050
TRX350D FOREMAN 4X4 87-89	2113-0050
TRX400AT RANCHER AT 04-07	2113-0050
TRX400FW FOREMAN 95-03	2113-0050
TRX450S FOREMAN S/ES 98-04	2113-0050
TRX500 FOURTRAX FOREMAN 4X4 05-07 (ALL)	2113-0050
TRX500 FOURTRAX RUBICON 01-08	2113-0050
TRX650 FOURTRAX RINCON STD. 03-05	2113-0050
(OPTIONAL COLD STARTING) 03-04	2113-0052 ²
TRX680 FOURTRAX RINCON 06-07	2113-0052 ²
KAWASAKI	
KLF220A BAYOU (CANADA) 92-02	2113-0051 ¹
KLF250A BAYOU (CANADA) 03-05	2113-0051 ¹
KAF300A MULE 91-05	2113-0051 ¹
KEF300A LAKOTA 95-00	2113-0051 ¹

FITS MODEL	PART #
FACTORY-ACTIVATED AGM BATTERIES (CON'T)	
KAWASAKI (CON'T)	
KEF300B LAKOTA SPORT 01-03	2113-0051 ¹
KLF300A BAYOU 86-87	-
KLF300B BAYOU 88-04	2113-0051 ¹
KLF300C BAYOU 4X4 89-04	2113-0051 ¹
KVF300A PRAIRIE 4X4 99-02	2113-0051 ¹
KVF300B PRAIRIE 99-02	2113-0051 ¹
KVF360A/B/C PRAIRIE 4X4 ADVANTAGE CLASSIC 03-08	2113-0051 ¹
KVF400A PRAIRIE 4X4 97-00	2113-0051 ¹
KVF400B/C PRAIRIE 4X4 98-02	2113-0051 ¹
KVF400C PRAIRIE 4X4 (CANADA) 99-02	2113-0050
KVF400D PRAIRIE 4X4 99-02	2113-0051 ¹
KVF400D PRAIRIE 4X4 (CANADA) 99-01	2113-0050
KAF620 MULE 3000/3010/3020 03-05	2113-0052
KAF620 MULE 3010 4X4 ADVANTAGE CLASSIC 03-07	2113-0052
KSV700 PRAIRIE 4X4 04-06	2113-0050
KVF750 BRUTE FORCE 4X4 05-08	2113-0050
KYMCO	
MXU300 (ALL)	2113-0049
MONGOOSE 250, MXU250 (ALL)	2113-0049
MXU150 (ALL)	2113-0048
50/90 MONGOOSE (ALL)	2113-0046
POLARIS	
200 PHOENIX 05-08	2113-0049
250 85-05 (ALL)	2113-0051 ¹
325 87-02 (ALL)	2113-0051 ¹
330 MAGNUM/TRAIL BOSS 03-08	2113-0051 ¹
335 SPORTSMAN 98-01	2113-0051 ¹
400 94-08 (ALL)	2113-0051 ¹
425 95-02 (ALL EXCEPT RANGER)	2113-0051 ¹
450 DIESEL (SECONDARY) 99-02	2113-0051 ¹
500 99-08 (ALL EXCEPT PREDATOR/RANGER/OUTLAW 525)	2113-0051 ¹
SUZUKI	
LT230E QUAD RUNNER 88-93	2113-0049
LT-F250/F QUAD RUNNER 88-02	2113-0051 ¹
LT-F250/F OZARK 02-08	2113-0049
LT300E QUAD RUNNER 87-89	2113-0051 ¹
LT-F300F KING QUAD 99-02	2113-0051 ¹
LT-4WD 250 87-99	2113-0051 ¹
LT-F4WDX KING QUAD 91-99	2113-0051 ¹
LT400 EIGER 02-07	2113-0050
LT-A450X KING QUAD 07-08	2113-0050
QUV620F 05	2113-0052 ²
LT-V700F TWIN PEAKS 04-05	2113-0050
YAMAHA	
YFU-1/YT PRO HAULER 89	2113-0051 ¹
YFM200 85	2113-0051 ¹
YFM200DX MOTO 4 86-89	2113-0051 ¹
YTM200E TRIMOTO 83-84	2113-0051 ¹
YTM200ER TRIMOTO 85	2113-0051 ¹
YFM225 86-88	2113-0051 ¹
YTM225DR TRIMOTO 85-86	2113-0051 ¹
YTM225DX TRIMOTO 83-84	2113-0051 ¹
YFM250 MOTO 4 89-91	2113-0051 ¹
YFM250 BEAR TRACKER 99-04	2113-0051 ¹
YFM250B BIG BEAR 07-08	2113-0051 ¹
YFM350ER MOTO 4 87-90/92-95	2113-0051 ¹
YFM350ERF 94	2113-0051 ¹
YFM350FW BIG BEAR 87-99	2113-0051 ¹
YFM350G/FG GRIZZLY 07-08	2113-0051 ¹
YFM350U BIG BEAR 96-99	2113-0051 ¹
YFP350 TERRA PRO 88	2113-0051 ¹
YFM350 BRUIN 04-06	2113-0051 ¹
YFM400FG GRIZZLY 07-08	2113-0051 ¹
YFM400FW KODIAK 93-95	2113-0051 ¹
YFM400FW KODIAK AUTOMATIC 96-02	2113-0052 ²
YFM400FW/N BIG BEAR 2X4/4X4 00-08	2113-0052 ²
YFM450FG GRIZZLY 07-08	2113-0052 ²
YFM450FW KODIAK AUTOMATIC 03-06	2113-0052 ²
YFM600FW GRIZZLY 98-01	2113-0052 ²
YFM660 GRIZZLY 02-08	2113-0052 ²
YFM700FG GRIZZLY 07-08	2113-0052 ²

¹ THIS BATTERY IS AN UPGRADE REPLACEMENT FOR THE FOLLOWING STANDARD BATTERIES: YB14A-A1, YB14A-A2, YB14-A2 AND YB14-B2.

² THIS BATTERY IS AN UPGRADE REPLACEMENT FOR THE FOLLOWING STANDARD BATTERY: YTX20L-BS.

PLOWS

WINCHES

UTV

RACKS

LUGGAGE

BODY

CONTROLS

ELECTRICAL

WHEELS & TIRES

SUSPENSION & DRIVE

ENGINE

NRA BY MOOSE

RIDER

TOWING

GARAGE

PROMO



AGM MAINTENANCE-FREE BATTERY > \$37.95-\$124.95

A heavy-duty maintenance-free 12 volt battery offering the quality you expect from Moose at affordable prices. Superior vibration resistance and durability provide a long service life. Holds a charge three times longer than conventional batteries. Absorbed glass mat battery eliminates water loss; permitting the battery to be permanently sealed once it is filled with acid. Acid pack is included. Imported.

PART #	EQUIVALENT YUASA PART #	PART #	EQUIVALENT YUASA PART #
2113-0225	YTX4L-BS	2113-0237	YTX14-BS
2113-0226	YTX5L-BS	2113-0235	YTX14AH-BS
2113-0227	YTX7A-BS	2113-0236	YTX14HL-BS
2113-0228	YTX7L-BS	2113-0238	YTX15L-BS
2113-0229	YTZ7S	2113-0241	YTX20HL-BS
2113-0230	YT7B-BS	2113-0242	YTX24HL-BS
2113-0231	YTX9-BS	2113-0243	YTX20CH-BS
2113-0232	YT9B-BS	2113-0244	YTX30L-BS
2113-0233	YTZ10S	2113-0245	U1-32
2113-0234	YTX12-BS		

FITS MODEL	PART #
AGM MAINTENANCE-FREE BATTERY	
AEON (BENZAI)	
COBRA/CX-SPORT 50/90/100 (ALL)	2113-0225
ARCTIC CAT	
90 06 (ALL EXCEPT DVX)	2113-0225
150 00-11	2113-0231
250/300 (ALL EXCEPT DVX)	2113-0236
366/400/500 (ALL EXCEPT DVX)	2113-0235
TRV400 09-10	2113-0235
550 PROWLER 10-11	2113-0242
650 4X4 AUTOMATIC 04-06	2113-0235
650 PROWLER 06-10	2113-0242
650H1/TBX650/MUDPRO 05-11	2113-0235
700 PROWLER 09-11	2113-0242
TRV700 06-08	2113-0235
1000 PROWLER 10-11	2113-0244
CAN-AM	
200 RALLY 02-06	2113-0235
330 OUTLANDER 04-05	2113-0238
400 OUTLANDER 03-04	2113-0238
400 OUTLANDER XT, MAX 04-11	2113-0241
650 QUEST (OPT) 02-05	2113-0242
OUTLANDER, MAX, RENEGADE 09-11	2113-0241
OUTLANDER, MAX 09-11	2113-0241
660 OUTLANDER EFI 06	2113-0241
800 OUTLANDER EFI RENEGADE 06-11	2113-0241
E-TON	
50/90 AXL/NXL/RXL/TXL 99-03	2113-0225
50/90 04-05 (ALL)	2113-0226 ¹
70 VIPER 11	2113-0226 ¹
DXL90 SIERRA 99-03	2113-0225
CXL150 YUKON II 00-11	2113-0231
YXL150 YUKON 00-03	2113-0231
150R VIPER 00-11	2113-0231
250 VECTOR 00-11	2113-0234

FITS MODEL	PART #
AGM MAINTENANCE-FREE BATTERY (CON'T)	
HONDA	
TRX125 FOURTRAX 87-88	2113-0231
TRX200 FOURTRAX 84	2113-0235
TRX200 FOURTRAX 90-96	2113-0234
TRX200SX FOURTRAX 86-88	2113-0234
TRX250 FOURTRAX 85-87	2113-0234
TRX250 FOURTRAX RECON 97-09	2113-0234
TRX250 RECON/ES 97-03	2113-0234
TRX250TE/TM 97-11	2113-0234
TRX300 FOURTRAX 88-00	2113-0237
TRX300FW FOURTRAX 4X4 88-00	2113-0237
FL350R ODYSSEY 85	2113-0234
TRX350 FOURTRAX 4X4 86-89	2113-0237
TRX350 RANCHER 00-06	2113-0237
TRX350D FOREMAN 4X4 87-89	2113-0237
FL400R PILOT 89-90	2113-0237
TRX400 RANCHER AT 04-06	2113-0237
TRX400X/EX FOURTRAX/SPORTRAX 99-11	2113-0231
TRX400FW FOREMAN 95-03	2113-0237
TRX420 FOURTRAX RANCHER 4X4 09-11	2113-0237
TRX450 FOURTRAX FOREMAN S/ES 98-04	2113-0237
TRX500 FE/FM/TM FOURTRAX FOREMAN/ES 4X4 05-11 (ALL)	2113-0237
TRX500FA FOURTRAX RUBICON 01-11	2113-0237
TRX650 FOURTRAX RINCON STD. 03-05	2113-0237
(OPTIONAL COLD STARTING) 03-04	2113-0241
TRX680FA FOURTRAX RINCON 06-11 (ALL)	2113-0241
HYOSUNG	
TE450S 00-11	2113-0231
KASEA	
MINI SKYHAWK 50 (ALL)	2113-0225
SKYHAWK 50/90 (ALL)	2113-0226 ¹
KS/KU (ALL)	2113-0227
SKYHAWK 150/170/250 (ALL)	2113-0227
ADVENTURE BUGGY 125/150 (ALL)	2113-0227
KAWASAKI	
KLF220A BAYOU (CANADA) 92-02	2113-0235
KLF250A BAYOU (CANADA) 03-05	2113-0235
KAF300A MULE 500/520/550 (ALL)	2113-0235
KEF300A LAKOTA 95-00	2113-0235
KLF300B BAYOU 88-04	2113-0235
KLF300C BAYOU 4X4 89-04	2113-0235
KVF300A/B PRAIRIE 4X4 99-02	2113-0235
KVF360 PRAIRIE 09-11	2113-0235
KAF400 MULE 600/610 05-11	2113-0235
KVF400A PRAIRIE 4X4 97-00	2113-0235
KVF400B/C PRAIRIE 4X4 98-02	2113-0235
KVF400D PRAIRIE 4X4 99-02	2113-0235
KAF620 MULE 3000/3010/3020 03-05	2113-0241
KAF620 MULE 3010 4X4 ADVANTAGE CLASSIC 03-07	2113-0241
KAF620F MULE 4010 4X4 09-10	2113-0241
KAF620F MULE 4010 4X4 09-11 (CN)	2113-0241
KYMCO	
50/90 MONGOOSE (ALL)	2113-0226
MXU150 (ALL)	2113-0231
MONGOOSE 250, MXU250 (ALL)	2113-0234
MONGOOSE 300, MXU300SD (ALL)	2113-0234
UXV500 4X4 00-11 (ALL)	2113-0241
POLARIS	
90 SCRAMBLER/SPORTSMAN 01-02	2113-0225
90 PREDATOR/SPORTSMAN/OUTLAW 03-11	2113-0226 ¹
170 RANGER RZR 11	2113-0234
200 PHOENIX/SAWTOOTH 05-11	2113-0234
250 85-05 (ALL)	2113-0235
325 87-02 (ALL)	2113-0235
330 MAGNUM/TRAIL BOSS 03-11	2113-0235
335 SPORTSMAN 98-01	2113-0235
400 94-08 (ALL)	2113-0235
400 SPORTSMAN 09-11	2113-0235
425 95-02 (ALL EXCEPT RANGER)	2113-0235
425 RANGER 2X4 02-03	2113-0244
450 DIESEL (PRIMARY) 99-03	2113-0244
450 DIESEL (SECONDARY) 99-03	2113-0235
500 99-10 (ALL EXCEPT PREDATOR/RANGER/SPORTSMAN EFI/OUTLAW)	2113-0235
500 SPORTSMAN H.O. 96-11	2113-0235
500 SPORTSMAN EFI 06-10	2113-0244
500 RANGER 6X6/4X4 98-04	2113-0244
500 RANGER 4X4 04-11	2113-0244

CONTINUED ON NEXT PAGE

FITS MODEL	PART #
AGM MAINTENANCE-FREE BATTERY (CON'T)	
POLARIS (CON'T)	
550 SPORTSMAN 09-10	2113-0241
550 SPORTSMAN EPS/XP 10-11	2113-0235
550 SPORTSMAN X2 10-11	2113-0241
600 SPORTSMAN 04-05	2113-0244
700 RANGER 6X6 06-10	2113-0244
700 SPORTSMAN, MILITARY 02-08	2113-0244
700 SPORTSMAN 09-10	2113-0244
800 RANGER 10-11	2113-0244
800 RANGER RZR 09-11	2113-0241
800 RANGER RZR 4 10-11	2113-0244
800 SPORTSMAN 05-11	2113-0244
QIANJIANG	
ATV50/100 (ALL)	2113-0225
SUZUKI	
LT230E QUAD RUNNER 88-93	2113-0234
LT-F250 QUAD RUNNER 88-01	2113-0235
LT-F250F QUAD RUNNER 99-02	2113-0235
LT-F250F OZARK 02-11	2113-0234
LT-4WD 250 87-99	2113-0235
LT-F4WDX KING QUAD 91-99	2113-0235
LT-F4WDX KING QUAD 99-02	2113-0235
LT300E QUAD RUNNER 300E 87-89	2113-0235
LT-F300F KING QUAD 99-02	2113-0235
LT400 EIGER 02-07 (ALL)	2113-0237
LT-A400 KING QUAD 09-11	2113-0237
LT-A450 KING QUAD 07-11	2113-0237
LT-A500 KING QUAD 00-11	2113-0243
LT-A500F/LT-F500F VINSON/MANUAL 4WD 04-07	2113-0243
QUV620F 05	2113-0241
LT-A700X KING QUAD 05-07	2113-0243
LT-A750X KING QUAD 07-11	2113-0243
YAMAHA	
YFU-1/TT PRO HAULER 89	2113-0235
YFM250 MOTO 4 89-91	2113-0235
YFM250 BEAR TRACKER 99-04	2113-0235
YFM250B BIG BEAR 07-10	2113-0235
YFM250B BRUIN 05-06	2113-0235
YFM350ER MOTO 4 87-95	2113-0235
YFM350FW BIG BEAR 87-99	2113-0235
YFM350FX WOLVERINE 06-10	2113-0235
YFM350G/FG GRIZZLY 07-11	2113-0235
YFM350V BIG BEAR 87-99	2113-0235
YFP350 TERRA PRO 88	2113-0235
YFM350B BRUIN 04-06	2113-0235
YFM400FB BIG BEAR 00-11	2113-0241
YFM400FG GRIZZLY 07-08	2113-0235
YFM400FW KODIAK 93-95	2113-0235
YFM400FW KODIAK AUTOMATIC 96-02	2113-0241
YFM400FW KODIAK AUTOMATIC 03-06	2113-0235
YFM400FW/N BIG BEAR 00-03	2113-0241
YXR440 RHINO 04-09 (ALL)	2113-0245
YFM450FG GRIZZLY 07-11	2113-0235
YFM450FX WOLVERINE 03-10	2113-0241
YFM550 GRIZZLY 09-11	2113-0241
YFM600FW/YFV600 GRIZZLY 98-01	2113-0241
YFM660FA GRIZZLY 02-08	2113-0241
YXR660 RHINO 04-07 (ALL)	2113-0245
YFM700FG GRIZZLY 07-11	2113-0241
YXR700 RHINO 08-09 (ALL)	2113-0245

¹ HIGH PERFORMANCE AGM MAINTENANCE-FREE BATTERY UPGRADE ALSO AVAILABLE, PART# 2113-0229

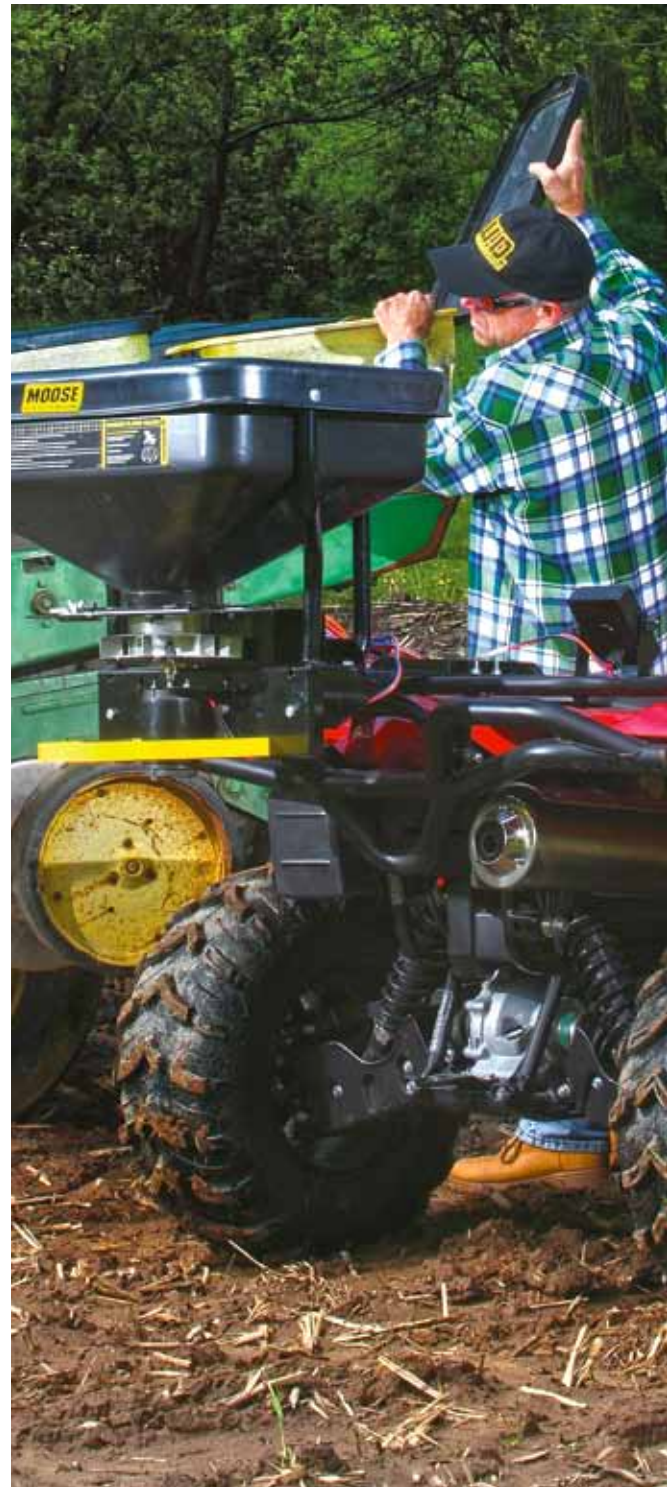

BATTERY TENDER® JUNIOR > \$8.95-\$33.95

Fully automatic two stage lead acid battery charger available in 12-volt model. Lightweight, compact size ideal for tight spots. Trickle charger maintains batteries after charging, ensures they are always primed to go. Ideal for all lead acid, sealed maintenance free and gel-cell batteries. After full 14.4 VDC charge is reached, converts to float charger and monitors battery at 13.2V. When voltage drops below 12.6 VDC charger resumes charging back to 14.4 VDC. Two color LED indicator. Spark proof; reverse polarity protected. Quick connect harness and 12' output cord. Imported.

DESCRIPTION	PART #
BATTERY TENDER® JUNIOR	3807-0026
ADDITIONAL QUICK CONNECT HARNESS	0810-0696

PLOW

WINCHES

UTV

RACKS

LUGGAGE

BODY

CONTROLS

ELECTRICAL

WHEELS & TIRES

SUSPENSION & DRIVE

ENGINE

NRA BY MOOSE

RIDER

TOWING

GARAGE

PROMO

STATORS > \$33.95-\$219.95

OEM style replacement stators. Designed to be complete bolt-on replacements with all connectors and grommets (unless otherwise noted). High output stators also available with additional electrical power. Made in the USA.



STATOR

REGULATOR/RECTIFIERS > \$33.95-\$219.95

OEM style replacement units. All regulator/rectifiers are designed as direct plug in units with all the correct connectors and terminals (unless otherwise noted). Heavy-duty parts also available that will regulate additional electrical current. Made in the USA.



REG/REC

COILS > \$33.95

Lighting, pulser/source and trigger coils are high quality OEM replacements. Hot shot ignition coils produce an enhanced spark for a cleaner, more complete burn, resulting in the potential for more power. All coils feature high-quality components for superior performance and long life. Imported.

FITS MODEL	REG/REC PART #	STATOR PART #
STATORS/REGULATOR/RECTIFIERS		
ARCTIC CAT		
250 2X4 99-00	2112-0553	-
250 2X4 01 (EARLY 2001)	2112-0553	-
250 2X4 01 (LATE 2001)	2112-0555	-
250 2X4 02	2112-0553	-
250 2X4 03 (EARLY 2003)	2112-0553	-
250 2X4 03 (LATE 2003)	2112-0555	-
250 2X4 04-05	2112-0555	-
250 4X4 00	2112-0553	-
250 4X4 01 (EARLY 2001)	2112-0553	-
250 4X4 01 (LATE 2001)	2112-0555	-
250 4X4 02	2112-0553	-
250 4X4 03 (EARLY 2003)	2112-0553	-
250 4X4 03 (LATE 2003)	2112-0555	-
250 4X4 04-05	2112-0555	-
300 2X4 05	2112-0555	-
300 2X4 98-01	2112-0553	-
300 2X4 02-03	2112-0555	-
300 4X4 98-00	2112-0553	-
300 4X4 01 (EARLY 2001)	2112-0553	-
300 4X4 01 (LATE 2001)	2112-0555	-
300 4X4 02-05	2112-0555	-
375 2X4 AUTOMATIC 2002	2112-0554	2112-0676
375 4X4 AUTOMATIC 2002	2112-0554	2112-0676
400 2X4 98-99	2112-0556	2112-0886
400 2X4 00	2112-0557	2112-0886
400 4X4 98-99	2112-0556	2112-0886
400 4X4 00	2112-0557	2112-0886
400 MANUAL 4X4 03	2112-0554	2112-0676
400 4X4 AUTOMATIC 03-04	2112-0554	2112-0676
400 2X4 MANUAL 01 (EARLY 2001)	2112-0557	2112-0886
400 2X4 MANUAL 01 (LATE 2001)	2112-0554	2112-0886
400 2X4 MANUAL 02	2112-0554	-
400 4X4 MANUAL 01 (EARLY 2001)	2112-0557	2112-0886
400 4X4 MANUAL 01 (LATE 2001)	2112-0554	2112-0886
400 4X4 MANUAL 02, 04	2112-0554	-
400 4X4 MANUAL 03	2112-0554	2112-0676
400 AUTOMATIC/(MANUAL: DELETE) 08	2112-0554	2112-0676
400ACT 4X4 AUTOMATIC 04	2112-0554	2112-0676
400ACT 4X4 MANUAL 04	2112-0554	2112-0676
400ACT MRP 4X4 AUTOMATIC/MANUAL 2004	-	2112-0676
400FIS AUTOMATIC 05-07	2112-0554	2112-0676
400FIS LE AUTOMATIC 05-07	-	2112-0676
400FIS 2X4 AUTOMATIC 03-04	2112-0554	2112-0676
400FIS 4X4 AUTOMATIC 03-04	2112-0554	2112-0676
400FIS MANUAL 05-07	2112-0554	2112-0676
400FIS 2X4 MANUAL 02	2112-0554	-
400FIS 2X4 MANUAL 03-04	2112-0554	2112-0676
400FIS 4X4 MANUAL 02	2112-0554	2112-0886
400FIS 4X4 MANUAL 03-04	2112-0554	2112-0676
400FIS MRP 4X4 AUTOMATIC/MANUAL 04	-	2112-0676
400TBX 4X4 AUTOMATIC 2004	-	2112-0676
400TBX 4X4 AUTOMATIC 05-06	2112-0554	2112-0676
400TRV 06-07	2112-0554	2112-0676
400VP 4X4 AUTOMATIC 05-06	2112-0554	2112-0676
400VP 4X4 MANUAL 05-06	2112-0554	2112-0676
400 2X4 98-00	-	2112-0886

FITS MODEL	REG/REC PART #	STATOR PART #
STATORS/REGULATOR/RECTIFIERS (CON'T)		
ARCTIC CAT (CON'T)		
400 4X4 98-00	-	2112-0886
400 MAN 2X4 01	-	2112-0886
400 MAN 4X4 01	-	2112-0886
400FIS MAN 2X4 02	-	2112-0886
400FIS MAN 4X4 02	-	2112-0886
454 2X4 BEARCAT 97-98	2112-0556	2112-0886
454 4X4 97-98	2112-0556	2112-0886 ⁹
454 BEARCAT 4X4 96	2112-0556	2112-0886 ¹²
454 2X4 BEARCAT 97-98	-	2112-0886
454 4X4 BEARCAT 96-98	-	2112-0886
500 4X4 98-99	2112-0556	2112-0886
500 AUTO 08-09	2112-0554	2112-0885
500 AUTOMATIC 4X4 00-02	2112-0554	2112-0675
500 AUTO LE 08-09	2112-0554	2112-0885
500 4X4 MANUAL 00	2112-0557	2112-0886
500 4X4 MANUAL 01 (EARLY 2001)	2112-0557	2112-0886
500 4X4 MANUAL 01 (LATE 2001)	2112-0554	2112-0886
500 4X4 MANUAL 02	2112-0554	-
500 MANUAL 08-09	2112-0554	2112-0885
500FIS 4X4 AUTOMATIC 02	2112-0554	2112-0675
500FIS AUTOMATIC 03-04	2112-0554	2112-0885
500FIS 4X4 AUTOMATIC CAT 04-07	2112-0554	2112-0885
500FIS 4X4 AUTOMATIC CAT 08	2112-0554	-
500FIS MANUAL 02	2112-0554	2112-0886
500FIS MANUAL 03	2112-0554	2112-0885
500FIS 4X4 MANUAL CAT 04-07	2112-0554	2112-0885
500FIS 4X4 MANUAL CAT 08	2112-0554	-
500TBX 4X4 AUTOMATIC 02	2112-0554	2112-0675
500TBX 4X4 AUTOMATIC 03-05	2112-0554	2112-0885
500TBX 4X4 AUTOMATIC 06	2112-0554	2112-0676
500TRV 4X4 AUTOMATIC CAT 03-05	2112-0554	2112-0885
500TRV 4X4 AUTOMATIC CAT 06	2112-0554	-
500 AUTO LE 08-09	-	2112-0885
500 AUTO 4X4 08-09	-	2112-0885
500 MAN 4X4 08-09	-	2112-0885
500FIS AUTO 4X4 03-07	-	2112-0885
500FIS MAN 4X4 03-07	-	2112-0885
500TBX AUTO 4X4 03-05	-	2112-0885
500TRV AUTO 4X4 03-05	-	2112-0885
500TRV AUTO 4X4 08	-	2112-0885
500 4X4 98-99	-	2112-0886
500 MAN 4X4 00-01	-	2112-0886
500FIS MAN 4X4 02	-	2112-0886
CAN-AM		
OUTLANDER 330 2X4 04-05	2112-0716	-
OUTLANDER 330 4X4 04	2112-0716	-
OUTLANDER 330 STD 4X4 05	2112-0716	-
OUTLANDER 330 XT 4X4 05	2112-0716	-
OUTLANDER 400 2X4 03-05	2112-0716	-
OUTLANDER 400 4X4 04	2112-0716	-
OUTLANDER 400 EFI STD/XT 08-12	2112-0540	-
OUTLANDER 400 MAX 04-05	2112-0716	-
OUTLANDER 400 STD 4X4 05	2112-0716	-
OUTLANDER 400 XT 4X4 04-05	2112-0716	-
OUTLANDER 400 MAX STD/XT 4X4 06-08	2112-0540	-
OUTLANDER 400 MAX EFI STD/XT 4X4 08-12	2112-0540	-
OUTLANDER 400 XT 4X4 2008	2112-0540	-
OUTLANDER 500 EFI 09-12	2112-0540	-
OUTLANDER 500 STD/XT 4X4 07-08	2112-0540	-
OUTLANDER MAX 500 STD/XT 4X4 07-12	2112-0540	-
RENEGADE 500 08-12	2112-0540	-
RENEGADE 500 EFI 2010-12	2112-0540	-
OUTLANDER 650 EFI 09-12	2112-0540	-
OUTLANDER 650 EFI XT 09	2112-0540	-
OUTLANDER 650 STD 4X4 06-08	2112-0540	-
OUTLANDER 650 XT 4X4 06-08	2112-0540	-
OUTLANDER MAX 650 STD 4X4 06-08	2112-0540	-
OUTLANDER MAX 650 XT 4X4 06-08	2112-0540	-
OUTLANDER 650 MAX EFI 09-12	2112-0540	-
OUTLANDER 650 MAX EFI XT 09	2112-0540	-
OUTLANDER 800 STD 4X4 06-08	2112-0540	-
OUTLANDER 800 XT 4X4 06-08	2112-0540	-
OUTLANDER MAX 800 LTD 4X4 07	2112-0540	-
OUTLANDER MAX 800 STD 4X4 06-08	2112-0540	-

CONTINUED ON NEXT PAGE

FITS MODEL	REG/REC PART #	STATOR PART #
STATORS/REGULATOR/RECTIFIERS (CON'T)		
CAN-AM (CON'T)		
OUTLANDER MAX 800 XT 4X4 06-08	2112-0540	-
OUTLANDER 800R EFI 09-10	2112-0540	-
OUTLANDER 800R EFI XT 09	2112-0540	-
OUTLANDER 800R MAX EFI 09-10	2112-0540	-
OUTLANDER 800R MAX EFI XT 09	2112-0540	-
RENEGADE 800 EFI STD 07-10	2112-0540	-
RENEGADE 800X EFI 08-09	2112-0540	-
HONDA		
ATC125M 84-85	2112-0671	-
TRX125 85-86	2112-0671	-
TRX125 87-88	2112-0670 ¹	-
ATC200ES BIG RED 82-84	2112-0668	-
TRX200 84	2112-0668	-
TRX200SX FOURTRAX 86-88	2112-0669	2112-0684 ¹⁰
TRX200 FOURTRAX 90-91	-	2112-0685 ¹⁶
TRX200D FOURTRAX 91-97	-	2112-0685 ¹⁶
TRX250 UTILITY MODEL 85-87	2112-0881	-
ATC250SX 85-87	-	2112-0690
TRX250 RECON 97-04	-	2112-0688 ¹⁷
TRX250 RECON ES 02-04	-	2112-0688 ¹⁷
TRX250 UTILITY MODEL 85-87	-	2112-0690
TRX300 FOURTRAX 2X4 & 4X4 88-92	2112-0525	-
TRX300 FOURTRAX 2X4 & 4X4 93-00	2112-0526	-
TRX350 FOURTRAX 86-87	-	2112-0489
TRX350D FOURTRAX 4X4 FOREMAN (D MODEL ONLY) 87-89	-	2112-0689 ¹⁷
TRX350FE RANCHER ES 4X4 00-05	2112-0527	2112-0687
TRX350FM RANCHER S 4X4 00-05	2112-0527	2112-0687
TRX350TE RANCHER ES 00-05	2112-0527	2112-0687
TRX350TM RANCHER S 00-05	2112-0527	2112-0687
TRX400FW FOREMAN 95-03	2112-0527	-
TRX450FM FOREMAN FOURTRAX 02-04	2112-0527	-
TRX450S/ES FOREMAN 98-01	2112-0527	-
TRX500FA FOREMAN RUBICON 05-09	-	2112-0774 ¹³
TRX500FE FOREMAN 4X4 ES 05-09	-	2112-0686 ¹⁴
TRX500FGA FOREMAN RUBICON GPS 05-08	-	2112-0774 ¹³
TRX500FM FOREMAN 4X4 05-09, 11	-	2112-0686 ¹⁴
TRX500 FPA FOURTRAX FOREMAN RUBICON 09, 11-12	-	2112-0774 ¹³
TRX500TM FOREMAN 05-06	-	2112-0686 ¹⁴
TRX500FPE FOURTRAX EPS 4X4 07-09, 11	-	2112-0686 ¹⁴
KAWASAKI		
KLF220 BAYOU 96-02	2112-0535	2112-0498
KLF250 BAYOU 03-11	2112-0535	2112-0498
KLF300A BAYOU 86-87	2112-0533	-
KLF300A BAYOU 86-87	-	2112-0887 ¹⁸
KLF300B BAYOU 88-91	2112-0533	2112-0482
KLF300B BAYOU 92-04	2112-0534/2112-0536	2112-0482 ¹¹
KLF300C BAYOU 89-91	2112-0533	2112-0482
KLF300C BAYOU 92-04	2112-0534/2112-0536	2112-0482 ¹¹
KVF300 PRAIRIE 99-02	2112-0536	2112-0691
KVF300 PRAIRIE 4X4 99-02	-	2112-0691
KVF360 PRAIRIE 2X4 & 4X4 03-09	2112-0536	2112-0692
KFX400 03-06	-	2112-0495 ¹⁰
KLF400B BAYOU 4X4 93-99	-	2112-0494 ¹⁰
KVF400D PRAIRIE 99-02	2112-0536	-
KVF400 PRAIRIE 4X4 97-98	-	2112-0693 ¹⁰
KVF650 BRUTE FORCE 4X4 05-13	2112-0536	2112-0496
KVF650 PRAIRIE 02-03	2112-0536	2112-0496
KVF650I BRUTE FORCE 4X4I 06	-	2112-0497
KVF650I BRUTE FORCE 4X4I 07-12	2112-0537	2112-0497
KFX700 04-09	2112-0536	2112-0493 ¹⁰
KSV700 V-FORCE 04-09	2112-0536	2112-0493 ¹⁰
KVF700 PRAIRIE 4X4 04-06	2112-0536	2112-0496
KVF750I BRUTE FORCE 4X4I 05-07	2112-0537	2112-0497
KVF750I BRUTE FORCE 4X4I 08-09	2112-0537	-
POLARIS		
SPORTSMAN 90 01-06	2112-0551	2112-0483
PHOENIX 200 05-13	2112-0883	-
SAWTOOTH 200 06-07	2112-0883	-
XPEDITION 325 00	-	2112-0888
XPEDITION 425 00-02	-	2112-0888
TRAIL BLAZER 250 91-98	2112-0546	-
TRAIL BLAZER 250 99-03	2112-0550	-
TRAIL BOSS 250 99	2112-0546	-
XPLORER 250 00-02	2112-0550	-
XPLORER 300 4X4 98	2112-0546	-

FITS MODEL	REG/REC PART #	STATOR PART #
STATORS/REGULATOR/RECTIFIERS (CON'T)		
POLARIS (CON'T)		
MAGNUM 325 2X4 00-02	2112-0548	2112-0682 ²
MAGNUM 325 4X4 00-02	2112-0548	2112-0682 ²
TRAIL BOSS 325 00-01	2112-0548	2112-0682 ²
TRAIL BOSS 325 02	2112-0548	2112-0682 ²
XPEDITION 325 00	2112-0548	-
XPEDITION 325 01-02	2112-0548	2112-0682 ²
ATP 330 4X4 04-05	-	2112-0683 ²
MAGNUM 330 2X4 03-05	-	2112-0683 ²
MAGNUM 330 HDS 03	-	2112-0683 ²
MAGNUM 330 4X4 03-06	-	2112-0683 ²
TRAIL BOSS 330 03-09	-	2112-0683 ²
TRAIL BLAZER 330 09	-	2112-0683 ²
SPORTSMAN 335 99-00	2112-0548	2112-0486
WORKER 335 99	-	2112-0486
400L 2X4 94	-	2112-0487
400L 4X4 94	-	2112-0487
400L 6X6 94	-	2112-0487
400L SPORT 2X4 95	-	2112-0487
400L SPORT 4X4 95	-	2112-0487
BIG BOSS 400L 6X6 95-97	-	2112-0487
RANGER 400 4X4 10	-	2112-0680 ²⁰
SPORTSMAN 400 94-97	-	2112-0487
SPORTSMAN 400 01-02	2112-0548	2112-0486
SPORTSMAN 400 03	-	2112-0488
SPORTSMAN 400 04 (EARLY 2004)	-	2112-0488
SPORTSMAN 400 04-05	-	2112-0680
SPORTSMAN 400 HD 4X4 08-10	-	2112-0690
XPLORER 400 98-02	2112-0548	2112-0487
XPLORER 400 4X4 95	-	2112-0487
XPLORER 400L 96-97	2112-0549	2112-0487
XPRESS 400L 96	2112-0549	2112-0487
XPRESS 400L 97	2112-0549	2112-0487
MAGNUM 425 2X4 95-98	-	2112-0486
MAGNUM 425 4X4 95	-	2112-0486
MAGNUM 425 4X4 96-97	2112-0549	2112-0486
MAGNUM 425 4X4 98-99	-	2112-0486
MAGNUM 425 6X6 96-98	-	2112-0486
XPEDITION 425 00-02	2112-0548	-
SPORTSMAN 450 HD 06-07	-	2112-0680 ¹⁵
BIG BOSS 500 6X6 98-01	-	2112-0484
BIG BOSS 500 6X6 02 (EARLY 2002)	-	2112-0485
BIG BOSS 500 6X6 02 (LATE 2002)	-	2112-0488 ⁴
MAGNUM 500 4X4 98	2112-0547	-
MAGNUM 500 4X4 99	2112-0547	2112-0484
MAGNUM 500 4X4 00 (EARLY 2000)	2112-0547	2112-0484 ⁸
MAGNUM 500 4X4 00 (LATE 2000)	2112-0547	2112-0485
MAGNUM 500 4X4 01	2112-0547	2112-0485
MAGNUM 500 4X4 02 (EARLY 2002)	2112-0547	2112-0485
MAGNUM 500 4X4 02 (LATE 2002)	2112-0547	2112-0488 ⁶
MAGNUM 500 4X4 03	-	2112-0488 ⁶
RANGER 500 02	-	2112-0681 ²⁵
RANGER 500 4X4 03	-	2112-0488
RANGER 500 4X4 EFI 06-12	-	2112-0677 ²¹
RANGER 500 6X6 2003	-	2112-0485
SPORTSMAN 500 4X4 96-97	2112-0549	2112-0486
SPORTSMAN 500 4X4 98-99	2112-0547	2112-0484
SPORTSMAN 500 4X4 00 (EARLY 2000)	2112-0547	2112-0484 ⁷
SPORTSMAN 500 4X4 00 (LATE 2000)	2112-0547	2112-0485
SPORTSMAN 500 4X4 01	2112-0547	2112-0485
SPORTSMAN 500 4X4 02 (EARLY 2002)	2112-0547	2112-0485
SPORTSMAN 500 4X4 02 (LATE 2002)	2112-0547	2112-0488 ⁵
SPORTSMAN 500 4X4 03	-	2112-0488
SPORTSMAN 500 4X4 04 NON-EFI	-	2112-0488/ 2112-0680 ¹⁵
SPORTSMAN 500 6X6 98	2112-0547	2112-0484
SPORTSMAN 500 6X6 99 ONLY	2112-0547	2112-0484
SPORTSMAN 500 6X6 00	2112-0547	2112-0484/ 2112-0485
SPORTSMAN 500 6X6 01	2112-0547	2112-0484
SPORTSMAN 500 6X6 02 (EARLY 2002)	2112-0547	2112-0485
SPORTSMAN 500 6X6 02 (LATE 2002)	2112-0547	2112-0488 ⁵
SPORTSMAN 500 6X6 03	-	2112-0488
SPORTSMAN 500 6X6 04	-	2112-0680 ¹⁵
SPORTSMAN 500 6X6 05, 07-08	-	2112-0680 ¹⁵
SPORTSMAN 500 (NON EFI) 05-06, 08-09	-	2112-0680 ¹⁵

CONTINUED ON NEXT PAGE

PLOW

WINCHES

UTV

RACKS

LUGGAGE

BODY

CONTROLS

ELECTRICAL

WHEELS & TIRES

SUSPENSION & DRIVE

ENGINE

NRA

BY MODE

RIDER

TOWING

GARAGE

PROMO

FITS MODEL	REG/REC PART #	STATOR PART #
STATORS/REGULATOR/RECTIFIERS (CON'T)		
POLARIS (CON'T)		
SPORTSMAN 500EFI 06-09	-	2112-0677 ²¹
SPORTSMAN X2 500 EFI 06-09	-	2112-0677 ²¹
SPORTSMAN TOURING 500 EFI 08-09	-	2112-0677 ²¹
WORKER 500 99-00	2112-0547	-
WORKER 500 01	2112-0547	2112-0485
WORKER 500 02 (EARLY 2002)	2112-0547	2112-0485
WORKER 500 02 (LATE 2002)	2112-0547	2112-0488
XPLORER 500 97	2112-0549	2112-0486
SPORTSMAN 600 03	-	2112-0681 ²³
SPORTSMAN 600 04	2112-0552	2112-0678 ²⁴
SPORTSMAN 600 04	2112-0552	2112-0681 ²⁶
SPORTSMAN 600 04	2112-0552	2112-0679 ²³
SPORTSMAN 700 02-EARLY 03 & EARLY 04	-	2112-0681
SPORTSMAN 700 04	2112-0552	2112-0678 ²⁴
SPORTSMAN 700 04	2112-0552	2112-0679 ²²
SPORTSMAN 700(NON EFI) 05-06	-	2112-0678
SPORTSMAN 700 EFI 05-06	-	2112-0679 ²³
SPORTSMAN 700 X2 EFI 08	-	2112-0773
RANGER 700 EFI 4X4/6X6 08-09	-	2112-0773
RANGER 800 EFI 4X4/6X6 10-11	-	2112-0773
RZR 800 EFI 09-11	-	2112-0773
RZR 800 EFI "S" MODEL 09-11	-	2112-0773
SPORTSMAN 800 EFI 05-07	-	2112-0679
SPORTSMAN 800 EFI 08-11	-	2112-0773
SPORTSMAN 800 EFI 6X6 09-11	-	2112-0773
SUZUKI		
LT-F 160 QUADRUNNER 160 91-04	2112-0530	-
LT-F 250 QUADRUNNER 250 88-89	2112-0530	-
LT-F 250 QUADRUNNER 250 90-01	2112-0530	-
LT-F 250 QUADRUNNER 250F 02	2112-0672	-
LT-F 250F KING QUAD 4X4 00	2112-0530	-
LT-F 250F KING QUAD 4X4 01	2112-0530	-
LT250EF 85-86	2112-0528	2112-0699
LT-4WD QUADRUNNER 4WD 87-89	2112-0530	-
LT-4WD QUADRUNNER 4WD 90-96	2112-0530	-
LT300E QUADRUNNER 87-89	2112-0528	2112-0697
LT-F 300F KING QUAD 99-00	2112-0530	-
LT-F 300F KING QUAD 01	2112-0530	-
LT-F 300F KING QUAD 02	2112-0672	-
LT-F 4WDX KING QUAD 91-98	2112-0530	-
LT-F4WD 97-98	2112-0530	-
LTF 4WD KING QUAD 97-98	2112-0530	-
LT-A400 EIGER 2WD 02-07	2112-0673	2112-0696
LT-A400F EIGER 4WD 02-07	2112-0673	2112-0696
LT-A400F EIGER 4WD 08-09	2112-0673	-
LT-F400 KING QUAD 08-09	2112-0673	-
LTA450X KINGQUAD 07-09	2112-0882 ¹⁹	-
LTA500F VINSON 4X4 AUTO 02-07	2112-0882	-
LTA500X KINGQUAD 09	2112-0882	-
LTA500X KINGQUAD 11-12	2112-0882	-
LTF500F VINSON 4X4 MANUAL 04-07	2112-0882	-
LTA500F QUADMASTER 00	2112-0531	2112-0502
LTA500F QUADMASTER 01	2112-0532	2112-0502
LT-A500F VINSON 4X4 AUTOMATIC 02-07	-	2112-0695
LTF500F QUADRUNNER 98-99	2112-0529	2112-0502
LTF500F QUADRUNNER 00	2112-0531	2112-0502
LTF500F QUADRUNNER 01	2112-0532	2112-0502
LTF500F QUADRUNNER 02	2112-0532	2112-0501
LTF500F VINSON 4X4 MANUAL 04-07	-	2112-0695
LTA700X KING QUAD 4X4 06-07	-	2112-0698
LT-V700F TWIN PEAKS 2004-2005	2112-0536	2112-0496
LTA700X KINGQUAD 4X4 06-07	2112-0882	-
LTA750X KINGQUAD 08-09	2112-0882	-
LTA750X KINGQUAD 11-12	2112-0882	2112-0698
LTA750X KING QUAD 08-09	-	2112-0698
YAMAHA		
YFM125 GRIZZLY 04-11	2112-0541	-
YFB250F TIMBERWOLF 92-93	-	2112-0889
YFB250F TIMBERWOLF 94-96	2112-0544	2112-0514
YFB250F TIMBERWOLF 97-00	2112-0543	2112-0514
YFM250 89-91	2112-0542	2112-0506
YFM250 BEAR TRACKER 99-00	2112-0543	2112-0514
YFM250 BEAR TRACKER 01-03	2112-0541	2112-0509
YFM250 BIG BEAR 07-10	2112-0541	-
YFM250 BRUIN 05-06	2112-0541	-

FITS MODEL	REG/REC PART #	STATOR PART #
STATORS/REGULATOR/RECTIFIERS (CON'T)		
YAMAHA (CON'T)		
YFM250X BEAR TRACKER 04	2112-0541	2112-0509
YFM350 BIG BEAR 87	2112-0542	2112-0511
YFM350 BIG BEAR 88-89	2112-0542	2112-0504
YFM350 BIG BEAR 90-94	2112-0542	2112-0508
YFM350 BIG BEAR 95	2112-0544	2112-0512
YFM350 BIG BEAR 2WD 98	2112-0543	2112-0513
YFM350 BIG BEAR 2X4 97	2112-0543	2112-0513
YFM350 BRUIN 2X4 & 4X4 04-06	2112-0541	2112-0890
YFM350 GRIZZLY 07-12	2112-0541	2112-0890
YFM350 MOTO 4 87	2112-0542	2112-0511
YFM350 MOTO 4 88-89	2112-0542	2112-0504
YFM350 MOTO 4 90-94	2112-0542	2112-0508
YFM350 MOTO 4 95	2112-0544	2112-0512
YFM350FW BIG BEAR 4X4 96	2112-0544	2112-0513
YFM350FW BIG BEAR 4X4 97	2112-0543	2112-0513
YFM350FW BIG BEAR 4X4 98-99	2112-0543	2112-0515
YFM350FWBJ BIG BEAR 4WD SE 97	2112-0543	2112-0515
YFM350SE BIG BEAR 4WD 97	2112-0543	2112-0515
YFM350 BRUIN 04-06	-	2112-0890
YFM350 GRIZZLY 07-12	-	2112-0890
YFM400 BIG BEAR 98-99	2112-0543	2112-0515
YFM400 BIG BEAR 00-01	2112-0543	2112-0505
YFM400 BIG BEAR 02-11	2112-0541	2112-0505
YFM400 GRIZZLY 07	2112-0541	2112-0519
YFM400 KODIAK 93-95	2112-0544	2112-0512
YFM400 KODIAK 96-98	2112-0543	2112-0513
YFM400 KODIAK 99	2112-0543	2112-0520
YFM400 KODIAK 2WD 00-01	2112-0541	2112-0519
YFM400 KODIAK 2WD 03-04	2112-0541	2112-0519
YFM400 KODIAK 4WD 00-02	2112-0541	2112-0519
YFM450 GRIZZLY 4WD 07-11	2112-0541	2112-0519
YFM450 KODIAK 4WD 03-06	2112-0541	2112-0519
YXR450 RHINO 06-09	2112-0539	-
YFM600 GRIZZLY 98	2112-0543	2112-0516
YFM600 GRIZZLY 99-01	2112-0541	2112-0516
YFM660 GRIZZLY 02-06	2112-0539	2112-0522 ¹⁰
YFM660 GRIZZLY 07-08	2112-0539	-
YXR660 RHINO 04-07	2112-0539	2112-0522 ¹⁰
YFM700 GRIZZLY 07-09	2112-0540	2112-0775
YFM700 GRIZZLY 10-12	2112-0540	2112-0775

FITS MODEL	EXCITER COIL	LIGHTING COIL	PULSER COIL
COILS			
POLARIS			
250 2X4 93	2102-0245	-	-
250 4X4 93	2102-0245	-	-
250 6X6 93	2102-0245	-	-
BIG BOSS 250 4X6 89-92	2102-0245	-	-
BIG BOSS 250 6X6 91-92	2102-0245	-	-
TRAIL BLAZER 250 91-06	2102-0245	-	-
TRAIL BOSS 250 2X4&4X4 89-92	2102-0245	-	-
TRAIL BOSS 250ES 88	2102-0245	-	-
TRAIL BOSS 250R 88	2102-0245	-	-
XPLORER 250 00-02	2102-0245	-	-
300 2X4 94-95	2102-0245	-	-
300 4X4 94-95	2102-0245	-	-
300 6X6 94	2102-0245	-	-
TRAIL BOSS 300 2X4/4X4 95	2102-0245	-	-
XPLORER 300 4X4 96-02	2102-0245	-	-
XPRESS 300 1996-1999	2102-0245	-	-
350L 2X4/4X4 93-94	2102-0245	-	-
350L 6X6 93-94	2102-0245	-	-
TRAIL BOSS 350L 2X4/4X4 90-92	2102-0245	-	-
YAMAHA			
YFM200 MOTO 4 86-89	-	-	2102-0194
YTM200E TRI-MOTO SHAFT DRIVE 83-84	-	-	2102-0194
YTM200ER YAMAHAVALER 85-87	-	-	2102-0194
YTM225DR TRI-MOTO 85-86	-	-	2102-0194
YTM225DX TRI-MOTO 83-85	-	-	2102-0194
YTM200 TRI-MOTO CHAIN DRIVE 83-86	-	2102-0195	-
YTM200E TRI-MOTO SHAFT DRIVE 83-84	-	2102-0195	-
YTM200ER YAMAHAVALER 85-86	-	2102-0195	-

FOOTNOTES CONTINUED ON NEXT PAGE

FOOTNOTES: FOR STATORS/REGULATOR/RECTIFIERS

- ¹ 200 WATTS
² RE-USE LARGE 8 PLACE CONNECTOR.
³ EXCITER COIL ONLY
⁴ FITS SERIAL # 02-00894 AND UP
⁵ FITS SERIAL # 02-022574 AND UP
⁶ FITS SERIAL # 02-02358 AND UP
⁷ FITS UP TO SERIAL # 00-29083
⁸ FITS UP TO SERIAL #00-01960
⁹ FOR EARLY 97, MUST USE WIRE HARNESS CONNECTOR 2120-0242
¹⁰ HIGH OUTPUT STATOR
¹¹ IF DEM REG/REC HAS A GANG PLUG ATTACHED DIRECTLY TO THE REG/REC BODY, USE 2112-0534. IF IT HAS PLUGS COMING OFF WITH WIRE LEADS USE 2112-0536.
¹² MUST USE WIRE HARNESS CONNECTOR 2120-0242
¹³ NO CONNECTOR/GROMMET/. REUSE OLD ONES.
¹⁴ NO CONNECTOR/GROMMET/TRIGGER. REUSE OLD ONES.
¹⁵ NO CONNECTORS
¹⁶ NO GROMMET. REUSE OLD ONE
¹⁷ NO GROMMET/TRIGGER. REUSE OLD ONES
¹⁸ NO TRIGGER
¹⁹ PLUG MOUNTED FLUSH TO REC/REG; THERE IS A SMALL SCREW THROUGH THE FINS BY DESIGN
²⁰ REPLACES OE# 3089546 & 3089249. NO CONNECTORS.
²¹ REPLACES OE#: 3089959 & 3089906
²² 04 SPORTSMAN 600/700. POLARIS USED 3 DIFFERENT STATORS. THIS IS AN 18 POLE STATOR; OD IS 108MM* T/OCLMESS OS 26MM. IT ALSO HAS ON ODD 6 GANG CONNECTOR (WHITE MOLDED PLASTIC W/CLIPS SIDES & USES STANDARD 250 FEMAL SPADE TERMINALS). REPLACES OE# 4010911
²³ 04 SPORTSMAN 600/700. POLARIS USED 3 DIFFERENT STATORS. THIS IS AN 18 POLE STATOR; OD IS 108MM* T/OCLMESS OS 26MM. IT ALSO HAS ON ODD 6 GANG CONNECTOR (WHITE MOLDED PLASTIC W/CLIPS SIDES & USES STANDARD 250 FEMAL SPADE TERMINALS). REPLACES OE# 4010911; REC/REG (IF BUILT BETWEEN 2/17/03 AND 4/05/04)
²⁴ 04 SPORTSMAN 600/700. POLARIS USED 3 STATORS. 18 POLE STATOR, OD IS 108MM; THICKNESS IS 18MM. THIS IS THE "KOKUSAN" SYLE STATOR. FOR 05 SPORTSMAN 700 NON EFI: THERE ARE 2 STATORS. REPLACES OE# 4010901; REC/REG (IF BUILT BETWEEN 2/17/03 AND 4/05/04)
²⁵ FOR 04 SPORTSMAN 600/700, POLARIS USED MULTIPLE STATORS. FOR THE CORRECT PART, CHECK THE PHYSICAL DESCRIPTION. THIS IS A 12 POLE STATOR WITH A SOURCE COIL. HAS A 390 OHM TRIGGER. REPLACES OE#:2202602 &4010709
²⁶ FOR 04 SPORTSMAN 600/700, POLARIS USED MULTIPLE STATORS. FOR THE CORRECT PART, CHECK THE PHYSICAL DESCRIPTION. THIS IS A 12 POLE STATOR WITH A SOURCE COIL. HAS A 390 OHM TRIGGER. REPLACES OE#:2202602 &4010710; REC/REG (IF BUILT BETWEEN 2/17/03 AND 4/05/04)

**POWER PORTS > \$26.95**

Ideal for the ATV that needs an extra power outlet. All necessary wiring included. May be used as a plug-in for all types of 12-volt accessories. Includes an O-ring gasket and weather flap for protection against the elements. Works with any 12-volt battery. Imported.

(DO NOT USE AS A CIGARETTE LIGHTER)

POWER PORTS	PART #
RECTANGULAR POWER PORT	MD-9100
ROUND POWER PORT	MD-9101

**UNIVERSAL STARTER SOLENOID > \$38.95**

Fits universal solenoid for many ATVs and UTVs with round starter housings. Multiple connections for easy installation. Instructions included. Imported.

DESCRIPTION	PART #
UNIVERSAL STARTER SOLENOID	2110-0392



PLOWS

WINCHES

UTV

RACKS

LUGGAGE

BODY

CONTROLS

ELECTRICAL

WHEELS & TIRES

SUSPENSION & DRIVE

ENGINE

NRA BY MOOSE

RIDER

TOWING

GARAGE

PROMO



STARTERS > \$82.95-\$219.95

Built to OEM specifications. Direct bolt-on replacements. Made in the USA.

FITS MODEL	PART #
STARTERS	
ARCTIC CAT	
250 2X4 99-05	2110-0344
250 4X4 00-05	2110-0344
250 UTILITY 06-09	2110-0388
300 2X4 99-03	2110-0344
300 4X4 98-05	2110-0344
375 2X4 AUTOMATIC 02	2110-0346
375 4X4 AUTOMATIC 02	2110-0346
400 4X4 AUTOMATIC 03	2110-0346
400 4X4 MANUAL 03	2110-0346
400ACT 4X4 AUTOMATIC 04	2110-0346
400ACT 4X4 MANUAL 04	2110-0346
400FIS AUTOMATIC 05-07	2110-0346
400FIS 2X4 AUTOMATIC 03-04	2110-0346
400FIS 4X4 AUTOMATIC 03-04	2110-0346
400FIS MANUAL 05-07	2110-0346
400FIS 2X4 MANUAL 03-04	2110-0346
400FIS 4X4 MANUAL 03-04	2110-0346
400TBX 4X4 AUTOMATIC 04-06	2110-0346
400TRV 06-07	2110-0346
400VP 4X4 AUTOMATIC 05-06	2110-0346
400VP 4X4 MANUAL 05-06	2110-0346
500TBX 4X4 AUTOMATIC 06	2110-0346
500 AUTO LE 08	2110-0419
500 AUTO 4X4 00-02	2110-0419
500 AUTO 4X4 08	2110-0419
500FIS AUTO LE 05-06	2110-0419
500FIS AUTO 4X4 02-08	2110-0419
500FIS MAN 4X4 03-08	2110-0419
500FIS MPR AUTO 04	2110-0419
500FIS MPR MANUAL 04	2110-0419
500TBX AUTO 4X4 02-05	2110-0419
500TRV AUTO 4X4 04-06	2110-0419
500TRV AUTO 4X4 08	2110-0419
650 HI FIS 07	2110-0419
650 HI FIS LE 07	2110-0419
650 HI TBX 07	2110-0419
650 HI TRV 07	2110-0419
650 HI TRV LE 07	2110-0419
ETON	
AXL50 LIGHTNING 00-01	2110-0358
RXL50 VIPER 02-04	2110-0358
TXL50 THUNDER ALL YEARS	2110-0358
RXL70 VIPER 2 STROKE 04-07	2110-0359
AXL90 LIGHTNING 2 STROKE ALL YEARS	2110-0359
DXL90 SIERRA 2 STROKE 00-05	2110-0359
RXL90 VIPER 2 STROKE 02-07	2110-0359
TXL90 THUNDER 2 STROKE 00-01	2110-0359
HONDA	
TRX200 FOURTRAX 90	2110-0420
TRX200D FOURTRAX 91-97	2110-0420
ATC250ES BIG RED 85-86	2110-0328
ATC250ES BIG RED 87	2110-0331
ATC250SX 85-86	2110-0328
ATC250SX 87	2110-0331
TRX250 RECON 97-07	2110-0334
TRX250 UTILITY MODEL 85-86	2110-0328
TRX250 UTILITY MODEL 87	2110-0331
TRX300 FOURTRAX 2X4 & 4X4 88-00	2110-0331
TRX350 FOURTRAX 85-86	2110-0329
TRX350 FOURTRAX 87-89	2110-0332
TRX350 RANCHER 00-06	2110-0330
TRX400FW FOREMAN 95-03	2110-0335
TRX450FM FOREMAN FOURTRAX 02-04	2110-0335
TRX450S/ES FOREMAN 98-04	2110-0335
TRX500 FOREMAN FOURTRAX 05-09	2110-0335
TRX500 RUBICON 00	2110-0336
TRX500FA RUBICON 01-03	2110-0336

FITS MODEL	PART #
STARTERS (CON'T)	
KAWASAKI	
KLF220 BAYOU 88-02	2110-0338
KLF250 BAYOU 03-09	2110-0338
KAF300A MULE 500 90-93	2110-0340
KAF300B MULE 500 94-96	2110-0340
KAF300C MULE 550 97-04	2110-0340
KAF300D MULE 520 00-01	2110-0340
KEF300A LAKOTA 95-03	2110-0337
KEF300B LAKOTA SPORT 01-03	2110-0337
KLF300A BAYOU 86-87	2110-0337
KLF300B BAYOU 88-04	2110-0337
KLF300C BAYOU 89-04	2110-0337
KVF300 PRAIRIE 99-02	2110-0337
KAF400A MULE 610 4X4 05-09	2110-0341
KAF400B MULE 600 05-09	2110-0341
KAF400C MULE 610 4X4 CAMO 05-08	2110-0341
KLF400B BAYOU 4X4 93-99	2110-0339
KVF400D PRAIRIE 97-02	2110-0339
KVF650 BRUTE FORCE 4X4 05-06	2110-0421
KVF650 PRAIRIE 4X4 02-03	2110-0421
KVF650I BRUTE FORCE 4X4I 06-12	2110-0421
KVF700 PRAIRIE 4X4 04-06	2110-0421
KVF750I BRUTE FORCE 4X4I 05-12	2110-0421
KAF620A MULE 2510 4X4 93-00	2110-0342
KAF620B MULE 2520 TURF 93-00	2110-0342
KAF620C MULE 2500 94-00	2110-0342
POLARIS	
SPORTSMAN 90 01-06	2110-0359
SPORTSMAN 90 (4 STROKE) 07-13	2110-0405
PHOENIX 200 05-12	2110-0360
SAWTOOTH 200 06-07	2110-0360
CYCLONE 250 87	2110-0354
TRAIL BOSS 250 85-89	2110-0354
TRAIL BOSS 250 90-99	2110-0354
TRAIL BOSS 250 2X4 88-92	2110-0354
TRAIL BOSS 250 4X4 87-89	2110-0354
TRAIL BOSS 250 4X4 90-93	2110-0354
XPLORER 250 01	2110-0354
300 2X4 94-95	2110-0354
300 4X4 94-95	2110-0354
TRAIL BOSS 300 2X4 95	2110-0354
TRAIL BOSS 300 4X4 95	2110-0354
XPLORER 300 97-00	2110-0354
XPLORER 300 4X4 95-00	2110-0354
XPRESS 300 96-99	2110-0354
MAGNUM 325 2X4 00-02	2110-0355
MAGNUM 325 4X4 00-02	2110-0355
TRAIL BOSS 325 00-01	2110-0355
MAGNUM 330 03-06	2110-0355
TRAIL BOSS 330 03-13	2110-0355
SPORTSMAN 335 99-00	2110-0355
WORKER 335 99	2110-0355
350L 2X4 93	2110-0354
350L 4X4 93	2110-0354
TRAIL BOSS 350L 2X4 91-92	2110-0354
TRAIL BOSS 350L 4X4 91-92	2110-0354
SPORTSMAN 400 94-00	2110-0354
SPORTSMAN 400 11-12	2110-0355
XPLORER 400 95-02	2110-0354
XPLORER 400L 96-97	2110-0354
XPRESS 400L 96-97	2110-0354
MAGNUM 425 2X4 95-98	2110-0355
MAGNUM 425 4X4 96-97	2110-0355
SPORTSMAN 450 06-07	2110-0355
MAGNUM 500 99-01	2110-0355
MAGNUM 500 4X4 97-03	2110-0355
SPORTSMAN 500 4X4 96-02	2110-0355
SPORTSMAN 500 4X4 03-06	2110-0355
SPORTSMAN 500 6X6 99-02	2110-0355
SPORTSMAN 500 6X6 03-04	2110-0355
SPORTSMAN 500X2 2-UP 06-08	2110-0355
WORKER 500 98-02	2110-0355
XPLORER 500 97-01	2110-0355
SPORTSMAN 600 03-05	2110-0356
SPORTSMAN 700 02-09	2110-0356
SPORTSMAN 800 EFI 05-13	2110-0356
SPORTSMAN 850XP 09-12	2110-0406

CONTINUED ON NEXT PAGE

FITS MODEL	PART #
STARTERS (CON'T)	
POLARIS (CON'T)	
SPORTSMAN 850XP ESP 10-13	2110-0406
RANGER 500 99	2110-0355
RANGER 500 2X4 05-08	2110-0355
RANGER 500 4X4 03-05	2110-0355
RANGER 500 4X4 06-07	2110-0355
RANGER 500 4X4 EFI 06-12	2110-0355
RANGER 500 6X6 03-05	2110-0355
RANGER 700 EFI 06-08	2110-0356
RANGER 700 EFI 4X4 09	2110-0356
RANGER 700 EFI 6X6 06-09	2110-0356
RANGER XP 700 4X4 06-07	2110-0356
RANGER 800 EFI 4X4 10-11	2110-0356
RANGER 800 EFI 6X6 10-12	2110-0356
RZR 800 EFI 08-12	2110-0356
RZR 800 EFI "S" MODEL 09-12	2110-0356
SUZUKI	
LT160 QUADRUNNER 03-04	2110-0423
LT160E QUADRUNNER 89-92	2110-0423
LTF160 QUADRUNNER 91-01	2110-0423
LT230E QUADRUNNER 88-93	2110-0423
LT-F250 QUADRUNNER 250 88-99	2110-0344
LT-F250X 99	2110-0344
LTF250 OZARK 02-09,11	2110-0423
LT-4WD QUADRUNNER 4WD 87-96	2110-0344
LT-F 300F KING QUAD 99	2110-0344
LT-F 4WDX KING QUAD 91-98	2110-0344
LT-F4WD 97-98	2110-0344
LTF 4WD KING QUAD 97-98	2110-0344
LT-A4002WD EIGER 2WD 02-07	2110-0346
LTA4004WD EIGER 4WD 02-07	2110-0346
LT-A450X 07-09	2110-0389
LT-A500X KING QUAD 09,11	2110-0389
LTA500F QUADMASTER 00-01	2110-0422
LTA500F VINSON 4X4 AUTO 02-07	2110-0422
LTF500F QUADRUNNER 00-02	2110-0422
LTF500F VINSON 4X4 MANUAL 04-07	2110-0422
YAMAHA	
YFM80 BADGER 92-01	2110-0347
YFM80 GRIZZLY 05-08	2110-0347
YFM80 MOTO 4 85-91	2110-0347
YFM100 CHAMP 87-91	2110-0347
YFA125 BREEZE 89-04	2110-0353
YFM125 GRIZZLY 04-11	2110-0353
YFM200 MOTO 4 85-89	2110-0348
YTM200 TRI-MOTO CHAIN DRIVE 83-86	2110-0348
YTM200E TRI-MOTO SHAFT DRIVE 83-84	2110-0348
YTM200ER YAMAHUALER 85-86	2110-0348
YFM225 MOTO 4 86-88	2110-0348
YTM225DR TRI-MOTO 85-86	2110-0348
YTM225DX TRI-MOTO 83-85	2110-0348
YFB250F TIMBERWOLF 92-00	2110-0348
YFM250 89-91	2110-0348
YFM250 BEAR TRACKER 99-03	2110-0348
YFM250 BIG BEAR 09-10	2110-0348
YFM350 BIG BEAR 87-96	2110-0349
YFM350 BIG BEAR 2WD 96-98	2110-0349
YFM350 MOTO 4 87-95	2110-0349
YFM350 WOLVERINE 95-05	2110-0350
YFM350FW BIG BEAR 4X4 96	2110-0349
YFM350FW BIG BEAR 4X4 98-99	2110-0350
YFM350FWBJ BIG BEAR 4WD SE 97	2110-0350
YFM350 BIG BEAR 4WD 97	2110-0349
YFP350 TERRAPRO 88-89	2110-0349
YFM400 BIG BEAR 00-12	2110-0350
YFM400 GRIZZLY 07	2110-0352
YFM400 KODIAK 93-98	2110-0349
YFM400 KODIAK 99	2110-0350
YFM400 KODIAK 2WD 03-04	2110-0352
YFM400 KODIAK 4WD 02-06	2110-0352
YFM450 GRIZZLY 4WD 07-09	2110-0352
YFM450 KODIAK 4WD 03-06	2110-0352
YFM450 WOLVERINE SPORT 4X4 06-09	2110-0352
YFM600 GRIZZLY 98-01	2110-0352
YFM660 GRIZZLY 02-08	2110-0352
YXR660 RHINO 04-07	2110-0352



PLOWS

WINCHES

UTV

RACKS

LUGGAGE

BODY

CONTROLS

ELECTRICAL

WHEELS
& TIRESSUSPENSION
& DRIVE

ENGINE

NRA
BY MOOSE

RIDER

TOWING

GARAGE

PROMO

901X *tires*

901X TIRE > \$85.95-\$156.95

The Moose 901X with its offset V-tread design and side lugs offers high performance in mud, snow and sand. 6 ply construction for superior durability and puncture resistance. Lugs are recessed in the center for added surface area and better traction. Pebbled design inbetween the lugs makes for easier clean out when riding in sticky clay and mud. Imported.

DESCRIPTION	PLY	PART #
901X TIRE		
25X8-12	6	0320-0419
25X10-12	6	0320-0420
26X9-12	6	0320-0421
26X12-12	6	0320-0422

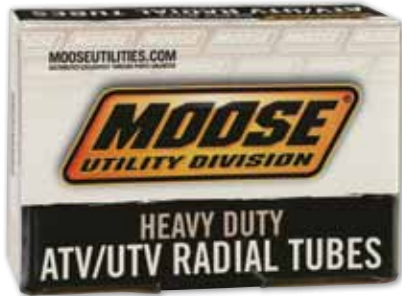

ATV/UTV INNER TUBES > \$8.95-\$22.95

High quality, heavy duty rubber inner tubes. Heavy duty valves. Diverse range of sizes. Suitable for use on bias and radial applications. Imported.

DESCRIPTION	PLY	PART #
INNER TUBES		
8.00-6/7	TR6	0351-0036
13X5.00-6	JS87P	0351-0035
13X6.50-6	JS87P	0351-0035
145/70-6	JS87P	0351-0035
14X5.50-6	JS87P	0351-0035
15X6.50-8	TR6	0351-0046
16X6.00-8	TR6	0351-0046
16X6.50-8	TR6	0351-0046
16X7.50-8	TR6	0351-0046
16X8.00-7	TR6	0351-0036
17X7.00-8	TR6	0351-0046
18X10.50-10	TR6	0351-0041
18X11.00-8	TR6	0351-0037
18X6.50-8	TR6	0351-0046
18X7.00-8	TR6	0351-0046
18X7.50-8	TR6	0351-0046
18X8.50-10	TR6	0351-0041
18X8.50-8	TR6	0351-0037
18X9.50-11	TR6	0351-0037
19X7.00-8	TR6	0351-0046
19X8.00-10	TR6	0351-0040
20X10.00-10	TR6	0351-0041
20X10.00-8	TR6	0351-0037
20X10.00-9	TR6	0351-0039
20X11.00-9	TR6	0351-0039
20X12.00-9	TR6	0351-0039
20X7.00-8	TR6	0351-0046
20X7.00-9	TR6	0351-0038
20X8.00-10	TR6	0351-0041

DESCRIPTION	PLY	PART #
INNER TUBES (CON'T)		
20X8.00-8	TR6	0351-0037
21X10.00-8	TR6	0351-0037
21X11.00-8	TR6	0351-0037
21X11.00-9	TR6	0351-0039
21X12.00-8	TR6	0351-0037
21X7.00-10	TR6	0351-0040
21X8.00-10	TR6	0351-0041
21X8.00-9	TR6	0351-0038
21X9.00-10	TR6	0351-0041
21X9.00-8	TR6	0351-0037
22X10.00-10	TR6	0351-0041
22X10.00-8	TR6	0351-0037
22X11.00-10	TR6	0351-0041
22X11.00-8	TR6	0351-0037
22X11.00-9	TR6	0351-0039
22X12.00-8	TR6	0351-0037
22X7.00-10	TR6	0351-0040
22X7.00-11	TR6	0351-0042
22X7.00-9	TR6	0351-0038
22X8.00-10	TR6	0351-0040
22X8.00-11	TR6	0351-0042
22X9.00-10	TR6	0351-0041
22X9.00-8	TR6	0351-0037
23X10.00-10	TR6	0351-0041
23X10.00-11	TR6	0351-0042
23X10.00-9	TR6	0351-0039
23X10.50-12	TR6	0351-0042
23X12.00-10	TR6-OFF	0351-0045
23X7.00-10	TR6	0351-0040

DESCRIPTION	PLY	PART #
INNER TUBES (CON'T)		
23X8.00-11	TR6	0351-0042
23X8.00-12	TR6	0351-0042
23X8.50-11	TR6	0351-0042
23X9.00-10	TR6	0351-0041
24X10.00-11	TR6	0351-0042
24X10.00-12	TR6	0351-0042
24X11.00-10	TR6	0351-0041
24X11.00-9	TR6	0351-0039
24X12.00-12	TR6	0351-0044
24X13.00-9	TR6	0351-0039
24X13.50-9	TR6	0351-0039
24X8.00-11	TR6	0351-0042
24X8.00-12	TR6	0351-0042
24X9.00-11	TR6	0351-0042
25X10.00-12	TR6	0351-0044
25X11.00-10	TR6-OFF	0351-0045
25X12.00-10	TR6-OFF	0351-0045
25X12.00-12	TR6	0351-0044
25X12.00-9	TR6	0351-0039
25X13.50-10	TR6-OFF	0351-0045
25X13.50-9	TR6	0351-0039
25X8.00-10	TR6-OFF	0351-0045
25X8.00-12	TR6	0351-0042
26X12.00-12	TR6	0351-0044
26X9.00-12	TR6	0351-0043
27X10.00-12	TR6	0351-0043
27X10.50-12	TR6	0351-0043
27X12.00-12	TR6	0351-0044
27X9.50-12	TR6	0351-0043



427X wheels

427X ATV/UTV WHEELS > \$89.95

Built to meet the demands of the ATV/UTV market, Moose Utility Division is proud to introduce the 427X line of wheels. Whether it is in the woods, deep mud or sand, the 427X is prepared to take it on. Handles load capacities from 675 lbs for the 12x7 front to 1,150 lbs for the 12x8 rear which meet, or exceed all current market requirements. Separate yourself from the herd with a line of wheels that are 100% x-rayed on the production line to ensure quality and reliability. Unique 8-lug look of a 1-ton truck heavy-duty wheel. This new look will give your ATV/UTV a new heavy duty look. Simulated plastic lugs are replaceable. Center caps are included with each wheel, but lug nuts must be ordered separately. Replacement fake lugs are available (0223-0112). Imported.

FITS MODEL	POSITION	SIZE	BOLT PATTERN	OFFSET	BLACK WHEEL PART #	LUG NUT CHROME (16-PK) PART #	LUG NUT BLACK (16-PK) PART #	CENTER CAP (4-PK) PART #
427X WHEELS								
HONDA								
TRX650/700 RINCON 4X4 02-13	FRONT	12X7	4/110	4+3	0230-0569	0232-0203	0232-0204	0232-0211
	REAR	12X8	4/110	4+4	0230-0570	0232-0203	0232-0204	0232-0211
TRX420AT/500AT RANCHER 09-13	FRONT	12X7	4/110	4+3	0230-0569	0232-0203	0232-0204	0232-0211
	REAR	12X8	4/110	4+4	0230-0570	0232-0203	0232-0204	0232-0211
BIG RED 700 MUV 09-13	FRONT	12X7	4/110	4+3	0230-0569	0232-0209	-	0232-0211
	REAR	12X8	4/110	4+4	0230-0570	0232-0209	-	0232-0211
KAWASAKI								
BRUTE FORCE 650I 4X4 06-13 (IRS MODEL)	FRONT	12X7	4/110	4+3	0230-0569	0232-0203	0232-0204	0232-0211
	REAR	12X8	4/110	4+4	0230-0570	0232-0203	0232-0204	0232-0211
BRUTE FORCE 750 4X4 05-13	FRONT	12X7	4/110	4+3	0230-0569	0232-0203	0232-0204	0232-0211
	REAR	12X8	4/110	4+4	0230-0570	0232-0203	0232-0204	0232-0211
POLARIS								
SPORTSMAN 335 99-06	FRONT	12X7	4/156	4+3	0230-0567	0232-0205	0232-0206	0232-0210
	REAR	12X8	4/156	4+4	0230-0568	0232-0205	0232-0206	0232-0210
SPORTSMAN 400/450 01-10	FRONT	12X7	4/156	4+3	0230-0567	0232-0205	0232-0206	0232-0210
	REAR	12X8	4/156	4+4	0230-0568	0232-0205	0232-0206	0232-0210
SPORTSMAN 500 96-13	FRONT	12X7	4/156	4+3	0230-0567	0232-0205	0232-0206	0232-0210
	REAR	12X8	4/156	4+4	0230-0568	0232-0205	0232-0206	0232-0210
MAGNUM 500 02-06	FRONT	12X7	4/156	4+3	0230-0567	0232-0205	0232-0206	0232-0210
	REAR	12X8	4/156	4+4	0230-0568	0232-0205	0232-0206	0232-0210
SPORTSMAN 600 03-08	FRONT	12X7	4/156	4+3	0230-0567	0232-0205	0232-0206	0232-0210
	REAR	12X8	4/156	4+4	0230-0568	0232-0205	0232-0206	0232-0210
SPORTSMAN 700 02-08	FRONT	12X7	4/156	4+3	0230-0567	0232-0205	0232-0206	0232-0210
	REAR	12X8	4/156	4+4	0230-0568	0232-0205	0232-0206	0232-0210
SPORTSMAN 800 05-13	FRONT	12X7	4/156	4+3	0230-0567	0232-0205	0232-0206	0232-0210
	REAR	12X8	4/156	4+4	0230-0568	0232-0205	0232-0206	0232-0210
RANGER 4X4 03-12	FRONT	12X7	4/156	4+3	0230-0567	0232-0205	0232-0206	0232-0210
	REAR	12X8	4/156	4+4	0230-0568	0232-0205	0232-0206	0232-0210
RANGER 900XP 13	FRONT	12X7	4/156	4+3	0230-0567	0232-0134	-	0232-0210
	REAR	12X8	4/156	4+4	0230-0568	0232-0134	-	0232-0210
RZR AND RZR-S 09-13	FRONT	12X7	4/156	4+3	0230-0567	0232-0205	0232-0206	0232-0210
	REAR	12X8	4/156	4+4	0230-0568	0232-0205	0232-0206	0232-0210
SPORTSMAN X2 500/550/800 09-13	FRONT	12X7	4/156	4+3	0230-0567	0232-0205	0232-0206	0232-0210
	REAR	12X8	4/156	4+4	0230-0568	0232-0205	0232-0206	0232-0210
SPORTSMAN XP 500/700/750/800/850 09-13	FRONT	12X7	4/156	4+3	0230-0567	0232-0203	0232-0204	0232-0210
	REAR	12X8	4/156	4+4	0230-0568	0232-0203	0232-0204	0232-0210
SUZUKI								
KING QUAD 450 05-13	FRONT	12X7	4/110	4+3	0230-0569	0232-0203	0232-0204	0232-0211
	REAR	12X8	4/110	4+4	0230-0570	0232-0203	0232-0204	0232-0211
KING QUAD 700/750 05-13	FRONT	12X7	4/110	4+3	0230-0569	0232-0203	0232-0204	0232-0211
	REAR	12X8	4/110	4+4	0230-0570	0232-0203	0232-0204	0232-0211
YAMAHA								
KODIAK 400/450 4X4 05-06	FRONT	12X7	4/110	4+3	0230-0569	0232-0203	0232-0204	0232-0211
	REAR	12X8	4/110	4+4	0230-0570	0232-0203	0232-0204	0232-0211
GRIZZLY 400/450/550/700 4X4 07-13	FRONT	12X7	4/110	4+3	0230-0569	0232-0203	0232-0204	0232-0211
	REAR	12X8	4/110	4+4	0230-0570	0232-0203	0232-0204	0232-0211
BIG BEAR 400 IRS 07-12	FRONT	12X7	4/110	4+3	0230-0569	0232-0203	0232-0204	0232-0211
	REAR	12X8	4/110	4+4	0230-0570	0232-0203	0232-0204	0232-0211
GRIZZLY 660 02-09	FRONT	12X7	4/110	4+3	0230-0569	0232-0203	0232-0204	0232-0211
	REAR	12X8	4/110	4+4	0230-0570	0232-0203	0232-0204	0232-0211
RHINO 450/660/700 04-13	FRONT	12X7	4/110	4+3	0230-0569	0232-0203	0232-0204	0232-0211
	REAR	12X8	4/110	4+4	0230-0570	0232-0203	0232-0204	0232-0211

PLOWS
WINCHES
UTV
RACKS
LUGGAGE
BODY
CONTROLS
ELECTRICAL
WHEELS & TIRES
SUSPENSION & DRIVE
ENGINE
NRA BY MOOSE
RIDER
TOWING
GARAGE
PROMO

393X *wheels*

393X ATV/UTV WHEELS > \$79.95-\$109.95

Built to meet the demands of the ATV/UTV market, Moose Utility Division is proud to introduce the 393X line of wheels. Whether it is in the woods, deep mud or sand, the 393X is prepared to take it on. Handles load capacities from 675 lbs. for the 12x7, 14x7 and 15x7 front to 1,150 lbs. for the 12x8 and 15x8 rear which meet, or exceed all current market requirements. Separate yourself from the herd with a line of wheels that are 100% x-rayed on the production line to ensure quality and reliability. Available in gloss black with chrome center caps and black torx head rivets. Center caps are included with each wheel, but lug nuts must be ordered separately. Imported.



FITS MODEL	POSITION	SIZE	BOLT PATTERN	OFFSET	BLACK WHEEL PART#	LUG NUT CHROME (16-PK) PART #	LUG NUT BLACK (16-PK) PART #	CENTER CAP (4-PK) PART #
393X WHEELS								
CAN-AM								
OUTLANDER 330/400/500/650/800 03-13	FRONT	12X7	4/136	4+3	0230-0518	0232-0203	0232-0204	0232-0248
	REAR	12X8	4/136	4+4	0230-0523	0232-0203	0232-0204	0232-0248
	FRONT	14X7	4/136	4+3	0230-0526	0232-0203	0232-0204	0232-0248
	REAR	14X8	4/136	4+4	0230-0531	0232-0203	0232-0204	0232-0248
	FRONT	15X7	4/136	4+3	0230-0534	0232-0203	0232-0204	0232-0248
RENEGADE 500/800/1000 09-13	FRONT	12X7	4/136	4+3	0230-0518	0232-0203	0232-0204	0232-0248
	REAR	12X8	4/136	4+4	0230-0523	0232-0203	0232-0204	0232-0248
	FRONT	14X7	4/136	4+3	0230-0526	0232-0203	0232-0204	0232-0248
	REAR	14X8	4/136	4+4	0230-0531	0232-0203	0232-0204	0232-0248
	FRONT	15X7	4/136	4+3	0230-0534	0232-0203	0232-0204	0232-0248
TRAXTER 500 4X4 99-06	FRONT	12X7	4/110	4+3	0230-0519	0232-0203	0232-0204	0232-0249
	REAR	12X8	4/110	2+6	0230-0521	0232-0203	0232-0204	0232-0249
	FRONT	14X7	4/110	4+3	0230-0527	0232-0203	0232-0204	0232-0249
	REAR	14X8	4/110	2+6	0230-0529	0232-0203	0232-0204	0232-0249
	FRONT	12X7	4/110	4+3	0230-0519	0232-0203	0232-0204	0232-0249
QUEST 650 01-06	FRONT	12X7	4/110	4+3	0230-0519	0232-0203	0232-0204	0232-0249
	REAR	12X8	4/110	2+6	0230-0521	0232-0203	0232-0204	0232-0249
	FRONT	14X7	4/110	4+3	0230-0527	0232-0203	0232-0204	0232-0249
	REAR	14X8	4/110	2+6	0230-0529	0232-0203	0232-0204	0232-0249
	FRONT	12X7	4/136	4+3	0230-0518	0232-0203	0232-0204	0232-0248
COMMANDER 800/1000 11-13	REAR	12X8	4/136	4+4	0230-0523	0232-0203	0232-0204	0232-0248
	FRONT	14X7	4/136	4+3	0230-0526	0232-0203	0232-0204	0232-0248
	REAR	14X8	4/136	4+4	0230-0531	0232-0203	0232-0204	0232-0248
	FRONT	15X7	4/136	4+3	0230-0534	0232-0203	0232-0204	0232-0248
	REAR	15X8	4/136	4+4	0230-0537	0232-0203	0232-0204	0232-0248
HONDA								
TRX250 RECON 08-13	FRONT	12X7	4/110	4+3	0230-0519	0232-0203	0232-0204	0232-0249
	REAR	12X8	4/110	2+6	0230-0521	0232-0203	0232-0204	0232-0249
TRX300 FOURTRAX 4X4 89-00	FRONT	12X7	4/110	4+3	0230-0519	0232-0203	0232-0204	0232-0249
	REAR	12X8	4/110	2+6	0230-0521	0232-0203	0232-0204	0232-0249
	FRONT	14X7	4/110	4+3	0230-0527	0232-0203	0232-0204	0232-0249
TRX350 RANCHER S-ES 4X4 00-06	REAR	14X8	4/110	2+6	0230-0529	0232-0203	0232-0204	0232-0249
	FRONT	12X7	4/110	4+3	0230-0519	0232-0203	0232-0204	0232-0249
	REAR	12X8	4/110	2+6	0230-0521	0232-0203	0232-0204	0232-0249
TRX400/420 RANCHER SA 4X4 04-13	FRONT	14X7	4/110	4+3	0230-0527	0232-0203	0232-0204	0232-0249
	REAR	14X8	4/110	2+6	0230-0529	0232-0203	0232-0204	0232-0249
	FRONT	12X7	4/110	4+3	0230-0519	0232-0203	0232-0204	0232-0249
TRX400 FOREMAN 4X4 96-06	REAR	12X8	4/110	2+6	0230-0521	0232-0203	0232-0204	0232-0249
	FRONT	14X7	4/110	4+3	0230-0527	0232-0203	0232-0204	0232-0249
	REAR	14X8	4/110	2+6	0230-0529	0232-0203	0232-0204	0232-0249
TRX420AT/500AT RANCHER 09-13 (IRS)	FRONT	12X7	4/110	4+3	0230-0519	0232-0203	0232-0204	0232-0249
	REAR	12X8	4/110	4+4	0230-0524	0232-0203	0232-0204	0232-0249
	FRONT	14X7	4/110	4+3	0230-0527	0232-0203	0232-0204	0232-0249
	REAR	14X8	4/110	4+4	0230-0532	0232-0203	0232-0204	0232-0249
	FRONT	15X7	4/110	4+3	0230-0535	0232-0203	0232-0204	0232-0249
TRX450/500 FOREMAN S-ES 4X4 98-13	REAR	15X8	4/110	4+4	0230-0538	0232-0203	0232-0204	0232-0249
	FRONT	12X7	4/110	4+3	0230-0519	0232-0203	0232-0204	0232-0249
	REAR	12X8	4/110	2+6	0230-0521	0232-0203	0232-0204	0232-0249
	FRONT	14X7	4/110	4+3	0230-0527	0232-0203	0232-0204	0232-0249
	REAR	14X8	4/110	2+6	0230-0529	0232-0203	0232-0204	0232-0249
TRX500 RUBICON 4X4 01-11	FRONT	12X7	4/110	4+3	0230-0519	0232-0203	0232-0204	0232-0249
	REAR	12X8	4/110	2+6	0230-0521	0232-0203	0232-0204	0232-0249
	FRONT	14X7	4/110	4+3	0230-0527	0232-0203	0232-0204	0232-0249
	REAR	14X8	4/110	2+6	0230-0529	0232-0203	0232-0204	0232-0249
TRX650/700 RINCON 4X4 02-13 (IRS)	FRONT	12X7	4/110	4+3	0230-0519	0232-0203	0232-0204	0232-0249
	REAR	12X8	4/110	4+4	0230-0524	0232-0203	0232-0204	0232-0249
	FRONT	14X7	4/110	4+3	0230-0527	0232-0203	0232-0204	0232-0249
	REAR	14X8	4/110	4+4	0230-0532	0232-0203	0232-0204	0232-0249
	FRONT	15X7	4/110	4+3	0230-0535	0232-0203	0232-0204	0232-0249
BIG RED 700 MUV 09-13	REAR	15X8	4/110	4+4	0230-0538	0232-0203	0232-0204	0232-0249
	FRONT	12X7	4/110	4+3	0230-0519	0232-0209	-	0232-0249
	REAR	12X8	4/110	4+4	0230-0524	0232-0209	-	0232-0249
	FRONT	14X7	4/110	4+3	0230-0527	0232-0209	-	0232-0249
	REAR	14X8	4/110	4+4	0230-0532	0232-0209	-	0232-0249
KAWASAKI	FRONT	15X7	4/110	4+3	0230-0535	0232-0209	-	0232-0249
	REAR	15X8	4/110	4+4	0230-0538	0232-0209	-	0232-0249
	FRONT	12X7	4/136	4+3	0230-0518	0232-0203	0232-0204	0232-0248
	REAR	12X8	4/136	2+6	0230-0520	0232-0203	0232-0204	0232-0248

CONTINUED ON NEXT PAGE

PLOWS
WINCHES
UTV
RACKS
LUGGAGE
BODY
CONTROLS
ELECTRICAL
WHEELS & TIRES
SUSPENSION & DRIVE
ENGINE
NRA BY MOOSE
RIDER
TOWING
GARAGE
PROMO

FITS MODEL	POSITION	SIZE	BOLT PATTERN	OFFSET	BLACK WHEEL PART#	LUG NUT CHROME (16-PK) PART #	LUG NUT BLACK (16-PK) PART #	CENTER CAP (4-PK) PART #
393X WHEELS (CON'T)								
KAWASAKI (CON'T)								
KLF300 BAYOU 89-05 (CON'T)	FRONT	14X7	4/136	4+3	0230-0526	0232-0203	0232-0204	0232-0248
	REAR	14X8	4/136	2+6	0230-0528	0232-0203	0232-0204	0232-0248
KVF360 PRAIRIE 02-07	FRONT	12X7	4/136	4+3	0230-0518	0232-0203	0232-0204	0232-0248
	REAR	12X8	4/136	2+6	0230-0520	0232-0203	0232-0204	0232-0248
	FRONT	14X7	4/136	4+3	0230-0526	0232-0203	0232-0204	0232-0248
	REAR	14X8	4/136	2+6	0230-0528	0232-0203	0232-0204	0232-0248
KLF400 BAYOU 93-05	FRONT	12X7	4/136	4+3	0230-0518	0232-0203	0232-0204	0232-0248
	REAR	12X8	4/136	2+6	0230-0520	0232-0203	0232-0204	0232-0248
	FRONT	14X7	4/136	4+3	0230-0526	0232-0203	0232-0204	0232-0248
	REAR	14X8	4/136	2+6	0230-0528	0232-0203	0232-0204	0232-0248
KVF400 PRAIRIE 97-06	FRONT	12X7	4/136	4+3	0230-0518	0232-0203	0232-0204	0232-0248
	REAR	12X8	4/136	2+6	0230-0520	0232-0203	0232-0204	0232-0248
	FRONT	14X7	4/136	4+3	0230-0526	0232-0203	0232-0204	0232-0248
	REAR	14X8	4/136	2+6	0230-0528	0232-0203	0232-0204	0232-0248
KVF650/700 PRAIRIE 02-06	FRONT	12X7	4/136	4+3	0230-0518	0232-0203	0232-0204	0232-0248
	REAR	12X8	4/136	2+6	0230-0520	0232-0203	0232-0204	0232-0248
	FRONT	14X7	4/136	4+3	0230-0526	0232-0203	0232-0204	0232-0248
	REAR	14X8	4/136	2+6	0230-0528	0232-0203	0232-0204	0232-0248
BRUTE FORCE 650 4X4 06-08 (STRAIGHT AXLE)	FRONT	12X7	4/136	4+3	0230-0518	0232-0203	0232-0204	0232-0248
	REAR	12X8	4/136	2+6	0230-0520	0232-0203	0232-0204	0232-0248
	FRONT	14X7	4/136	4+3	0230-0526	0232-0203	0232-0204	0232-0248
	REAR	14X8	4/136	2+6	0230-0528	0232-0203	0232-0204	0232-0248
BRUTE FORCE 650I 4X4 06-13 (IRS MODEL)	FRONT	12X7	4/110	4+3	0230-0519	0232-0203	0232-0204	0232-0249
	REAR	12X8	4/110	4+4	0230-0524	0232-0203	0232-0204	0232-0249
	FRONT	14X7	4/110	4+3	0230-0527	0232-0203	0232-0204	0232-0249
	REAR	14X8	4/110	4+4	0230-0532	0232-0203	0232-0204	0232-0249
BRUTE FORCE 750 4X4 05-13	FRONT	15X7	4/110	4+3	0230-0535	0232-0203	0232-0204	0232-0249
	REAR	15X8	4/110	4+4	0230-0538	0232-0203	0232-0204	0232-0249
	FRONT	12X7	4/110	4+3	0230-0519	0232-0203	0232-0204	0232-0249
	REAR	12X8	4/110	4+4	0230-0524	0232-0203	0232-0204	0232-0249
TERYX 750 08-13	FRONT	14X7	4/110	4+3	0230-0527	0232-0203	0232-0204	0232-0249
	REAR	14X8	4/110	4+4	0230-0532	0232-0203	0232-0204	0232-0249
	FRONT	15X7	4/110	4+3	0230-0535	0232-0203	0232-0204	0232-0249
	REAR	15X8	4/110	4+4	0230-0538	0232-0203	0232-0204	0232-0249
MULE 550/600/610 ALL YEARS	FRONT	12X7	4/136	4+3	0230-0518	0232-0203	0232-0204	0232-0248
	REAR	12X8	4/136	4+4	0230-0523	0232-0203	0232-0204	0232-0248
	FRONT	12X7	4/136	4+3	0230-0518	0232-0207	0232-0208	0232-0248
	REAR	12X8	4/136	4+4	0230-0523	0232-0207	0232-0208	0232-0248
MULE 2500/3000/4010 SERIES ALL ¹	FRONT	14X7	4/136	4+3	0230-0526	0232-0207	0232-0208	0232-0248
	REAR	14X8	4/136	4+4	0230-0531	0232-0207	0232-0208	0232-0248
	FRONT	15X7	4/136	4+3	0230-0534	0232-0207	0232-0208	0232-0248
	REAR	15X8	4/136	4+4	0230-0537	0232-0207	0232-0208	0232-0248
KYMCO								
500MUX SA 08-10/MXU IE 08-11/500 UXV 10-13	FRONT	12X7	4/110	4+3	0230-0519	0232-0203	0232-0204	0232-0249
	REAR	12X8	4/110	4+4	0230-0524	0232-0203	0232-0204	0232-0249
POLARIS								
SPORTSMAN 335 99-06	FRONT	12X7	4/156	4+3	0230-0517	0232-0205	0232-0206	0232-0248
	REAR	12X8	4/156	4+4	0230-0522	0232-0205	0232-0206	0232-0248
	FRONT	14X7	4/156	4+3	0230-0525	0232-0205	0232-0206	0232-0248
	REAR	14X8	4/156	4+4	0230-0530	0232-0205	0232-0206	0232-0248
	FRONT	15X7	4/156	4+3	0230-0533	0232-0205	0232-0206	0232-0248
	REAR	15X8	4/156	4+4	0230-0536	0232-0205	0232-0206	0232-0248
SPORTSMAN 400/450 01-09	FRONT	12X7	4/156	4+3	0230-0517	0232-0205	0232-0206	0232-0248
	REAR	12X8	4/156	4+4	0230-0522	0232-0205	0232-0206	0232-0248
	FRONT	14X7	4/156	4+3	0230-0525	0232-0205	0232-0206	0232-0248
	REAR	14X8	4/156	4+4	0230-0530	0232-0205	0232-0206	0232-0248
	FRONT	15X7	4/156	4+3	0230-0533	0232-0205	0232-0206	0232-0248
	REAR	15X8	4/156	4+4	0230-0536	0232-0205	0232-0206	0232-0248
SPORTSMAN 500 96-13	FRONT	12X7	4/156	4+3	0230-0517	0232-0205	0232-0206	0232-0248
	REAR	12X8	4/156	4+4	0230-0522	0232-0205	0232-0206	0232-0248
	FRONT	14X7	4/156	4+3	0230-0525	0232-0205	0232-0206	0232-0248
	REAR	14X8	4/156	4+4	0230-0530	0232-0205	0232-0206	0232-0248
	FRONT	15X7	4/156	4+3	0230-0533	0232-0205	0232-0206	0232-0248
	REAR	15X8	4/156	4+4	0230-0536	0232-0205	0232-0206	0232-0248
MAGNUM 500 02-06	FRONT	12X7	4/156	4+3	0230-0517	0232-0205	0232-0206	0232-0248
	REAR	12X8	4/156	4+4	0230-0522	0232-0205	0232-0206	0232-0248
	FRONT	14X7	4/156	4+3	0230-0525	0232-0205	0232-0206	0232-0248
	REAR	14X8	4/156	4+4	0230-0530	0232-0205	0232-0206	0232-0248

CONTINUED ON NEXT PAGE

FITS MODEL	POSITION	SIZE	BOLT PATTERN	OFFSET	BLACK WHEEL PART#	LUG NUT CHROME (16-PK) PART #	LUG NUT BLACK (16-PK) PART #	CENTER CAP (4-PK) PART #
393X WHEELS (CON'T)								
POLARIS (CON'T)								
MAGNUM 500 02-06 (CON'T)	FRONT	15X7	4/156	4+3	0230-0533	0232-0205	0232-0206	0232-0248
	REAR	15X8	4/156	4+4	0230-0536	0232-0205	0232-0206	0232-0248
SPORTSMAN 600 03-08	FRONT	12X7	4/156	4+3	0230-0517	0232-0205	0232-0206	0232-0248
	REAR	12X8	4/156	4+4	0230-0522	0232-0205	0232-0206	0232-0248
	FRONT	14X7	4/156	4+3	0230-0525	0232-0205	0232-0206	0232-0248
	REAR	14X8	4/156	4+4	0230-0530	0232-0205	0232-0206	0232-0248
SPORTSMAN 700 02-08	FRONT	15X7	4/156	4+3	0230-0533	0232-0205	0232-0206	0232-0248
	REAR	15X8	4/156	4+4	0230-0536	0232-0205	0232-0206	0232-0248
	FRONT	12X7	4/156	4+3	0230-0517	0232-0205	0232-0206	0232-0248
	REAR	12X8	4/156	4+4	0230-0522	0232-0205	0232-0206	0232-0248
SPORTSMAN 800 05-13	FRONT	14X7	4/156	4+3	0230-0525	0232-0205	0232-0206	0232-0248
	REAR	14X8	4/156	4+4	0230-0530	0232-0205	0232-0206	0232-0248
	FRONT	15X7	4/156	4+3	0230-0533	0232-0205	0232-0206	0232-0248
	REAR	15X8	4/156	4+4	0230-0536	0232-0205	0232-0206	0232-0248
SPORTSMAN XP 550/700/800/850 09-13 ²	FRONT	12X7	4/156	4+3	0230-0517	0232-0203	0232-0204	0232-0248
	REAR	12X8	4/156	4+4	0230-0522	0232-0203	0232-0204	0232-0248
	FRONT	14X7	4/156	4+3	0230-0525	0232-0203	0232-0204	0232-0248
	REAR	14X8	4/156	4+4	0230-0530	0232-0203	0232-0204	0232-0248
SPORTSMAN X2 500/550/800 09-13	FRONT	15X7	4/156	4+3	0230-0533	0232-0203	0232-0204	0232-0248
	REAR	15X8	4/156	4+4	0230-0536	0232-0203	0232-0204	0232-0248
	FRONT	12X7	4/156	4+3	0230-0517	0232-0205	0232-0206	0232-0248
	REAR	12X8	4/156	4+4	0230-0522	0232-0205	0232-0206	0232-0248
RANGER ALL 4X4 03-12	FRONT	14X7	4/156	4+3	0230-0525	0232-0205	0232-0206	0232-0248
	REAR	14X8	4/156	4+4	0230-0530	0232-0205	0232-0206	0232-0248
	FRONT	15X7	4/156	4+3	0230-0533	0232-0205	0232-0206	0232-0248
	REAR	15X8	4/156	4+4	0230-0536	0232-0205	0232-0206	0232-0248
RANGER XP 900 4X4 2013	FRONT	12X7	4/156	4+3	0230-0517	0232-0209	-	0232-0248
	REAR	12X8	4/156	4+4	0230-0522	0232-0209	-	0232-0248
	FRONT	14X7	4/156	4+3	0230-0525	0232-0209	-	0232-0248
	REAR	14X8	4/156	4+4	0230-0530	0232-0209	-	0232-0248
RANGER 400 / 400EV 10-13	FRONT	15X7	4/156	4+3	0230-0533	0232-0209	-	0232-0248
	REAR	15X8	4/156	4+4	0230-0536	0232-0209	-	0232-0248
	FRONT	12X7	4/156	4+3	0230-0517	0232-0205	0232-0206	0232-0248
	REAR	12X8	4/156	4+4	0230-0522	0232-0205	0232-0206	0232-0248
RZR AND RZR-S 09-13	FRONT	14X7	4/156	4+3	0230-0525	0232-0205	0232-0206	0232-0248
	REAR	14X8	4/156	4+4	0230-0530	0232-0205	0232-0206	0232-0248
	FRONT	15X7	4/156	4+3	0230-0533	0232-0205	0232-0206	0232-0248
	REAR	15X8	4/156	4+4	0230-0536	0232-0205	0232-0206	0232-0248
SUZUKI	FRONT	12X7	4/156	4+3	0230-0517	0232-0205	0232-0206	0232-0248
	REAR	12X8	4/156	4+4	0230-0522	0232-0205	0232-0206	0232-0248
	FRONT	14X7	4/156	4+3	0230-0525	0232-0205	0232-0206	0232-0248
	REAR	14X8	4/156	4+4	0230-0530	0232-0205	0232-0206	0232-0248
KING QUAD 400 (STRAIGHT AXLE) 4X4 08-12	FRONT	15X7	4/156	4+3	0230-0533	0232-0205	0232-0206	0232-0248
	REAR	15X8	4/156	4+4	0230-0536	0232-0205	0232-0206	0232-0248
	FRONT	12X7	4/110	4+3	0230-0519	0232-0203	0232-0204	0232-0249
	REAR	12X8	4/110	2+6	0230-0521	0232-0203	0232-0204	0232-0249
EIGER 400 4X4 02-07	FRONT	14X7	4/110	4+3	0230-0527	0232-0203	0232-0204	0232-0249
	REAR	14X8	4/110	2+6	0230-0529	0232-0203	0232-0204	0232-0249
	FRONT	12X7	4/110	4+3	0230-0519	0232-0203	0232-0204	0232-0249
	REAR	12X8	4/110	2+6	0230-0521	0232-0203	0232-0204	0232-0249
KING QUAD 450 05-13	FRONT	14X7	4/110	4+3	0230-0527	0232-0203	0232-0204	0232-0249
	REAR	14X8	4/110	2+6	0230-0529	0232-0203	0232-0204	0232-0249
	FRONT	12X7	4/110	4+3	0230-0519	0232-0203	0232-0204	0232-0249
	REAR	12X8	4/110	4+4	0230-0524	0232-0203	0232-0204	0232-0249
VINSON 500 4X4 02-08	FRONT	14X7	4/110	4+3	0230-0527	0232-0203	0232-0204	0232-0249
	REAR	14X8	4/110	4+4	0230-0532	0232-0203	0232-0204	0232-0249
	FRONT	15X7	4/110	4+3	0230-0535	0232-0203	0232-0204	0232-0249
	REAR	15X8	4/110	4+4	0230-0538	0232-0203	0232-0204	0232-0249
PROMO	FRONT	12X7	4/110	4+3	0230-0519	0232-0203	0232-0204	0232-0249
	REAR	12X8	4/110	2+6	0230-0521	0232-0203	0232-0204	0232-0249
	FRONT	14X7	4/110	4+3	0230-0527	0232-0203	0232-0204	0232-0249

PLOWS
WINCHES
UTV
RACKS
LUGGAGE
BODY
CONTROLS
ELECTRICAL
WHEELS & TIRES
SUSPENSION & DRIVE
ENGINE
NRA BY MOOSE
RIDER
TOWING
GARAGE

FITS MODEL	POSITION	SIZE	BOLT PATTERN	OFFSET	BLACK WHEEL PART#	LUG NUT CHROME (16-PK) PART #	LUG NUT BLACK (16-PK) PART #	CENTER CAP (4-PK) PART #
393X WHEELS (CON'T)								
SUZUKI (CON'T)								
VINSON 500 4X4 02-08 (CON'T)	REAR	14X8	4/110	2+6	0230-0529	0232-0203	0232-0204	0232-0249
TWIN PEAKS 700 04-07	FRONT	12X7	4/136	4+3	0230-0518	0232-0203	0232-0204	0232-0248
	REAR	12X8	4/136	2+6	0230-0520	0232-0203	0232-0204	0232-0248
	FRONT	14X7	4/136	4+3	0230-0526	0232-0203	0232-0204	0232-0248
KING QUAD 700/750 05-13	FRONT	12X7	4/110	4+3	0230-0519	0232-0203	0232-0204	0232-0249
	REAR	12X8	4/110	4+4	0230-0524	0232-0203	0232-0204	0232-0249
	FRONT	14X7	4/110	4+3	0230-0527	0232-0203	0232-0204	0232-0249
	REAR	14X8	4/110	4+4	0230-0532	0232-0203	0232-0204	0232-0249
	FRONT	15X7	4/110	4+3	0230-0535	0232-0203	0232-0204	0232-0249
	REAR	15X8	4/110	4+4	0230-0538	0232-0203	0232-0204	0232-0249
YAMAHA								
GRIZZLY 350 (STRAIGHT AXLE) 4X4 08-10	FRONT	12X7	4/110	4+3	0230-0519	0232-0203	0232-0204	0232-0249
	REAR	12X8	4/110	2+6	0230-0521	0232-0203	0232-0204	0232-0249
	FRONT	14X7	4/110	4+3	0230-0527	0232-0203	0232-0204	0232-0249
	REAR	14X8	4/110	2+6	0230-0529	0232-0203	0232-0204	0232-0249
BIG BEAR 350/400 2X4/4X4 07-06	FRONT	12X7	4/110	4+3	0230-0519	0232-0203	0232-0204	0232-0249
	REAR	12X8	4/110	2+6	0230-0521	0232-0203	0232-0204	0232-0249
	FRONT	14X7	4/110	4+3	0230-0527	0232-0203	0232-0204	0232-0249
	REAR	14X8	4/110	2+6	0230-0529	0232-0203	0232-0204	0232-0249
WOLVERINE 350/450 4X4 95-08	FRONT	12X7	4/110	4+3	0230-0519	0232-0203	0232-0204	0232-0249
	REAR	12X8	4/110	2+6	0230-0521	0232-0203	0232-0204	0232-0249
	FRONT	14X7	4/110	4+3	0230-0527	0232-0203	0232-0204	0232-0249
	REAR	14X8	4/110	2+6	0230-0529	0232-0203	0232-0204	0232-0249
BRUIN 350 2X4/4X4 04-06	FRONT	12X7	4/110	4+3	0230-0519	0232-0203	0232-0204	0232-0249
	REAR	12X8	4/110	2+6	0230-0521	0232-0203	0232-0204	0232-0249
	FRONT	14X7	4/110	4+3	0230-0527	0232-0203	0232-0204	0232-0249
	REAR	14X8	4/110	2+6	0230-0529	0232-0203	0232-0204	0232-0249
GRIZZLY 350 IRS 07-13	FRONT	12X7	4/110	4+3	0230-0519	0232-0203	0232-0204	0232-0249
	REAR	12X8	4/110	4+4	0230-0524	0232-0203	0232-0204	0232-0249
	FRONT	14X7	4/110	4+3	0230-0527	0232-0203	0232-0204	0232-0249
	REAR	14X8	4/110	4+4	0230-0532	0232-0203	0232-0204	0232-0249
	FRONT	15X7	4/110	4+3	0230-0535	0232-0203	0232-0204	0232-0249
	REAR	15X8	4/110	4+4	0230-0538	0232-0203	0232-0204	0232-0249
BIG BEAR 400 IRS '07-13	FRONT	12X7	4/110	4+3	0230-0519	0232-0203	0232-0204	0232-0249
	REAR	12X8	4/110	4+4	0230-0524	0232-0203	0232-0204	0232-0249
	FRONT	14X7	4/110	4+3	0230-0527	0232-0203	0232-0204	0232-0249
	REAR	14X8	4/110	4+4	0230-0532	0232-0203	0232-0204	0232-0249
	FRONT	15X7	4/110	4+3	0230-0535	0232-0203	0232-0204	0232-0249
	REAR	15X8	4/110	4+4	0230-0538	0232-0203	0232-0204	0232-0249
KODIAK 400/450 4X4 93-04	FRONT	12X7	4/110	4+3	0230-0519	0232-0203	0232-0204	0232-0249
	REAR	12X8	4/110	2+6	0230-0521	0232-0203	0232-0204	0232-0249
	FRONT	14X7	4/110	4+3	0230-0527	0232-0203	0232-0204	0232-0249
	REAR	14X8	4/110	2+6	0230-0529	0232-0203	0232-0204	0232-0249
KODIAK 400/450 4X4 05-06	FRONT	12X7	4/110	4+3	0230-0519	0232-0203	0232-0204	0232-0249
	REAR	12X8	4/110	4+4	0230-0524	0232-0203	0232-0204	0232-0249
	FRONT	14X7	4/110	4+3	0230-0527	0232-0203	0232-0204	0232-0249
	REAR	14X8	4/110	4+4	0230-0532	0232-0203	0232-0204	0232-0249
	FRONT	15X7	4/110	4+3	0230-0535	0232-0203	0232-0204	0232-0249
	REAR	15X8	4/110	4+4	0230-0538	0232-0203	0232-0204	0232-0249
GRIZZLY 400/450/550/700 4X4 07-13	FRONT	12X7	4/110	4+3	0230-0519	0232-0203	0232-0204	0232-0249
	REAR	12X8	4/110	4+4	0230-0524	0232-0203	0232-0204	0232-0249
	FRONT	14X7	4/110	4+3	0230-0527	0232-0203	0232-0204	0232-0249
	REAR	14X8	4/110	4+4	0230-0532	0232-0203	0232-0204	0232-0249
	FRONT	15X7	4/110	4+3	0230-0535	0232-0203	0232-0204	0232-0249
	REAR	15X8	4/110	4+4	0230-0538	0232-0203	0232-0204	0232-0249
GRIZZLY 600 4X4 98-01	FRONT	12X7	4/110	4+3	0230-0519	0232-0203	0232-0204	0232-0249
	REAR	12X8	4/110	2+6	0230-0521	0232-0203	0232-0204	0232-0249
	FRONT	14X7	4/110	4+3	0230-0527	0232-0203	0232-0204	0232-0249
	REAR	14X8	4/110	2+6	0230-0529	0232-0203	0232-0204	0232-0249
GRIZZLY 660 02-09	FRONT	12X7	4/110	4+3	0230-0519	0232-0203	0232-0204	0232-0249
	REAR	12X8	4/110	4+4	0230-0524	0232-0203	0232-0204	0232-0249
	FRONT	14X7	4/110	4+3	0230-0527	0232-0203	0232-0204	0232-0249
	REAR	14X8	4/110	4+4	0230-0532	0232-0203	0232-0204	0232-0249
	FRONT	15X7	4/110	4+3	0230-0535	0232-0203	0232-0204	0232-0249
	REAR	15X8	4/110	4+4	0230-0538	0232-0203	0232-0204	0232-0249
RHINO 450/660/700 04-13	FRONT	12X7	4/110	4+3	0230-0519	0232-0203	0232-0204	0232-0249
	REAR	12X8	4/110	4+4	0230-0524	0232-0203	0232-0204	0232-0249
	FRONT	14X7	4/110	4+3	0230-0527	0232-0203	0232-0204	0232-0249
	REAR	14X8	4/110	4+4	0230-0532	0232-0203	0232-0204	0232-0249
	FRONT	15X7	4/110	4+3	0230-0535	0232-0203	0232-0204	0232-0249
	REAR	15X8	4/110	4+4	0230-0538	0232-0203	0232-0204	0232-0249

¹ LIFT KIT NEEDED FOR 26" OR LARGER TIRES

² SPORTSMAN XP 2009 IS 5" WIDER WITH AFTER MARKET WHEELS

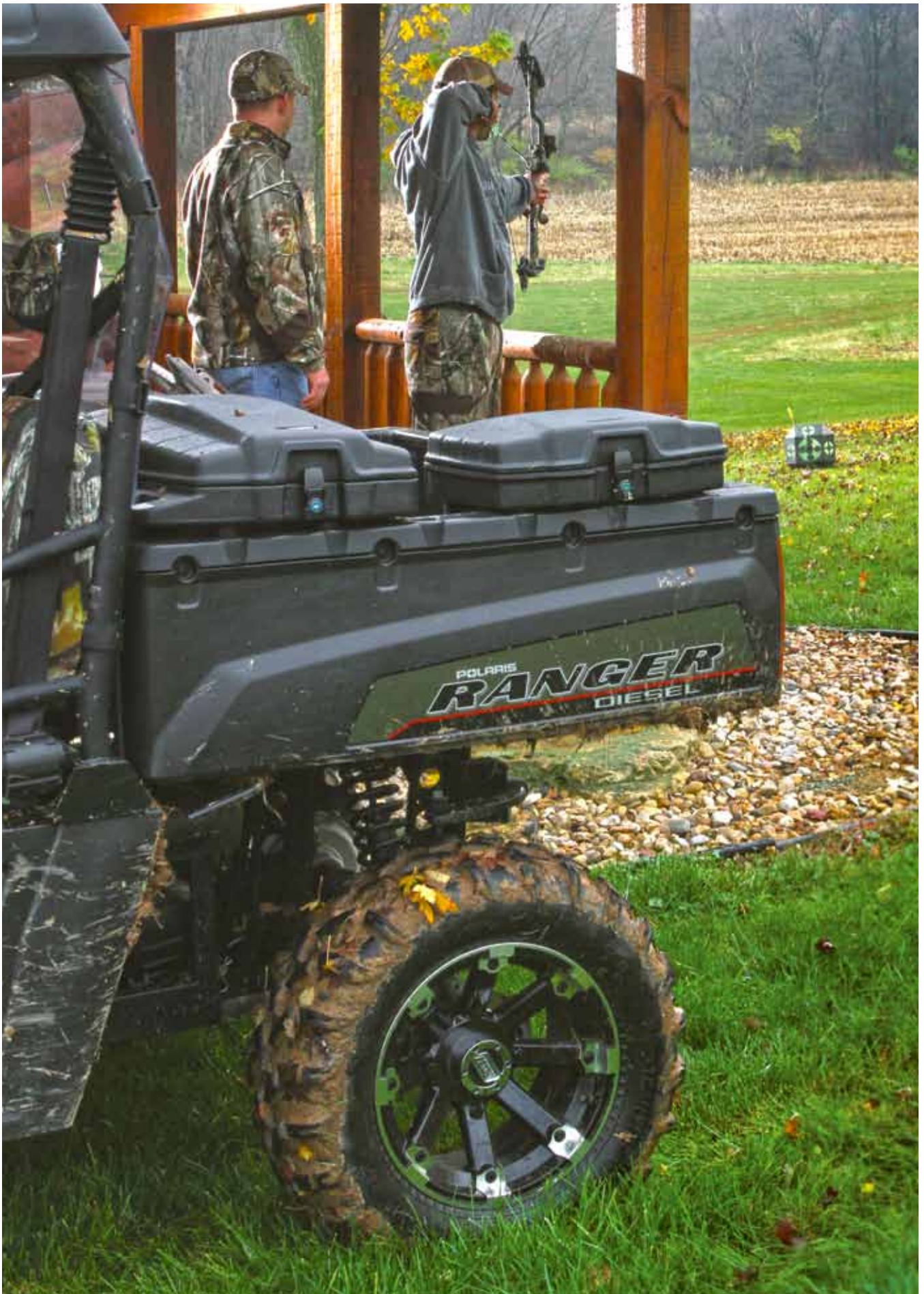

PLOWS

WINCHES

UTV

RACKS

LUGGAGE

BODY

CONTROLS

ELECTRICAL

WHEELS & TIRES

SUSPENSION & DRIVE

ENGINE

NRA
BY MOOSE

RIDER

TOWING

GARAGE

PROMO

387X wheels

387X ATV/UTV WHEELS > \$79.95-\$99.95

Built to meet the demands of the ATV/UTV market, Moose Utility Division is proud to introduce the 387X line of wheels. Whether it is in the woods, deep mud or sand, the 387X is prepared to take it on. Handles load capacities from 675 lbs. for the 12x7 front to 1,150 lbs. for the 12x8 rear which meet, or exceed all current market requirements. Separate yourself from the herd with a line of wheels that are 100% x-rayed on the production line to ensure quality and reliability. Available in gloss black or machined finish with chrome center caps and rivets. Center caps are included with each wheel, but lug nuts must be ordered separately. Imported.

MACHINED W/ BLACK



BLACK



FITS MODEL	POSITION	SIZE	BOLT PATTERN	OFFSET	MACHINED W/ BLACK WHEEL PART #	BLACK WHEEL PART #	LUG NUT CHROME (16-PK) PART #	LUG NUT BLACK (16-PK) PART #	CENTER CAP (4-PK) PART #
CAN-AM									
OUTLANDER 400/500/650/800/1000 03-13	FRONT	12X7	4/136	4+3	0230-0440	0230-0448	0232-0203	0232-0204	0232-0210
	REAR	12X8	4/136	4+4	0230-0445	0230-0453	0232-0203	0232-0204	0232-0210
	FRONT	14X7	4/136	4+3	0230-0456	0230-0464	0232-0203	0232-0204	0232-0210
	REAR	14X8	4/136	4+4	0230-0461	0230-0469	0232-0203	0232-0204	0232-0210
RENEGADE 500/800/100 09-13	FRONT	12X7	4/136	4+3	0230-0440	0230-0448	0232-0203	0232-0204	0232-0210
	REAR	12X8	4/136	4+4	0230-0445	0230-0453	0232-0203	0232-0204	0232-0210
	FRONT	14X7	4/136	4+3	0230-0456	0230-0464	0232-0203	0232-0204	0232-0210
	REAR	14X8	4/136	4+4	0230-0461	0230-0469	0232-0203	0232-0204	0232-0210
TRAXTER 4X4 99-06	FRONT	12X7	4/110	4+3	0230-0441	0230-0449	0232-0203	0232-0204	0232-0211
	REAR	12X8	4/110	2+6	0230-0443	0230-0451	0232-0203	0232-0204	0232-0211
	FRONT	14X7	4/110	4+3	0230-0457	0230-0465	0232-0203	0232-0204	0232-0211

CONTINUED ON NEXT PAGE

FITS MODEL	POSITION	SIZE	BOLT PATTERN	OFFSET	MACHINED W/ BLACK WHEEL PART#	BLACK WHEEL PART#	LUG NUT CHROME (16-PK) PART #	LUG NUT BLACK (16-PK) PART #	CENTER CAP (4-PK) PART #
387X WHEELS (CON'T)									
CAN-AM (CON'T)									
TRAXTER 4X4 99-06 (CON'T)	REAR	14X8	4/110	2+6	0230-0459	0230-0467	0232-0203	0232-0204	0232-0211
	FRONT	12X7	4/110	4+3	0230-0441	0230-0449	0232-0203	0232-0204	0232-0211
QUEST 650 01-06	REAR	12X8	4/110	2+6	0230-0443	0230-0451	0232-0203	0232-0204	0232-0211
	FRONT	14X7	4/110	4+3	0230-0457	0230-0465	0232-0203	0232-0204	0232-0211
	REAR	14X8	4/110	2+6	0230-0459	0230-0467	0232-0203	0232-0204	0232-0211
COMMANDER 800/1000 12-13	FRONT	12X7	4/136	4+3	0230-0440	0230-0448	0232-0203	0232-0204	0232-0210
	REAR	12X8	4/136	4+4	0230-0445	0230-0453	0232-0203	0232-0204	0232-0210
	FRONT	14X7	4/136	4+3	0230-0456	0230-0464	0232-0203	0232-0204	0232-0210
	REAR	14X8	4/136	4+4	0230-0461	0230-0469	0232-0203	0232-0204	0232-0210
HONDA									
TRX300 FOURTRAX 4X4 89-00	FRONT	12X7	4/110	4+3	0230-0441	0230-0449	0232-0203	0232-0204	0232-0211
	REAR	12X8	4/110	2+6	0230-0443	0230-0451	0232-0203	0232-0204	0232-0211
	FRONT	14X7	4/110	4+3	0230-0457	0230-0465	0232-0203	0232-0204	0232-0211
	REAR	14X8	4/110	2+6	0230-0459	0230-0467	0232-0203	0232-0204	0232-0211
TRX350 RANCHER S-ES 4X4 00-06	FRONT	12X7	4/110	4+3	0230-0441	0230-0449	0232-0203	0232-0204	0232-0211
	REAR	12X8	4/110	2+6	0230-0443	0230-0451	0232-0203	0232-0204	0232-0211
	FRONT	14X7	4/110	4+3	0230-0457	0230-0465	0232-0203	0232-0204	0232-0211
	REAR	14X8	4/110	2+6	0230-0459	0230-0467	0232-0203	0232-0204	0232-0211
TRX400/420 RANCHER 4X4 04-13	FRONT	12X7	4/110	4+3	0230-0441	0230-0449	0232-0203	0232-0204	0232-0211
	REAR	12X8	4/110	2+6	0230-0443	0230-0451	0232-0203	0232-0204	0232-0211
	FRONT	14X7	4/110	4+3	0230-0457	0230-0465	0232-0203	0232-0204	0232-0211
	REAR	14X8	4/110	2+6	0230-0459	0230-0467	0232-0203	0232-0204	0232-0211
TRX400 FOREMAN 4X4 96-06	FRONT	12X7	4/110	4+3	0230-0441	0230-0449	0232-0203	0232-0204	0232-0211
	REAR	12X8	4/110	2+6	0230-0443	0230-0451	0232-0203	0232-0204	0232-0211
	FRONT	14X7	4/110	4+3	0230-0457	0230-0465	0232-0203	0232-0204	0232-0211
	REAR	14X8	4/110	2+6	0230-0459	0230-0467	0232-0203	0232-0204	0232-0211
TRX450/500 FOREMAN S-ES 4X4 98-13	FRONT	12X7	4/110	4+3	0230-0441	0230-0449	0232-0203	0232-0204	0232-0211
	REAR	12X8	4/110	2+6	0230-0443	0230-0451	0232-0203	0232-0204	0232-0211
	FRONT	14X7	4/110	4+3	0230-0457	0230-0465	0232-0203	0232-0204	0232-0211
	REAR	14X8	4/110	2+6	0230-0459	0230-0467	0232-0203	0232-0204	0232-0211
TRX500 RUBICON 4X4 01-13	FRONT	12X7	4/110	4+3	0230-0441	0230-0449	0232-0203	0232-0204	0232-0211
	REAR	12X8	4/110	2+6	0230-0443	0230-0451	0232-0203	0232-0204	0232-0211
	FRONT	14X7	4/110	4+3	0230-0457	0230-0465	0232-0203	0232-0204	0232-0211
	REAR	14X8	4/110	2+6	0230-0459	0230-0467	0232-0203	0232-0204	0232-0211
TRX250 RECON 08-13	FRONT	12X7	4/110	4+3	0230-0441	0230-0449	0232-0203	0232-0204	0232-0211
	REAR	12X8	4/110	2+6	0230-0443	0230-0451	0232-0203	0232-0204	0232-0211
TRX650/700 RINCON 4X4 02-13	FRONT	12X7	4/110	4+3	0230-0441	0230-0449	0232-0203	0232-0204	0232-0211
	REAR	12X8	4/110	4+4	0230-0446	0230-0454	0232-0203	0232-0204	0232-0211
	FRONT	14X7	4/110	4+3	0230-0457	0230-0465	0232-0203	0232-0204	0232-0211
	REAR	14X8	4/110	4+4	0230-0462	0230-0470	0232-0203	0232-0204	0232-0211
TRX420AT/500AT RANCHER 09-13	FRONT	12X7	4/110	4+3	0230-0441	0230-0449	0232-0203	0232-0204	0232-0211
	REAR	12X8	4/110	4+4	0230-0446	0230-0454	0232-0203	0232-0204	0232-0211
	FRONT	14X7	4/110	4+3	0230-0457	0230-0465	0232-0203	0232-0204	0232-0211
	REAR	14X8	4/110	4+4	0230-0462	0230-0470	0232-0203	0232-0204	0232-0211
BIG RED 700 MUV 09-13	FRONT	12X7	4/110	4+3	0230-0441	0230-0449	0232-0209	-	0232-0211
	REAR	12X8	4/110	4+4	0230-0446	0230-0454	0232-0209	-	0232-0211
	FRONT	14X7	4/110	4+3	0230-0457	0230-0465	0232-0209	-	0232-0211
	REAR	14X8	4/110	4+4	0230-0462	0230-0470	0232-0209	-	0232-0211
KAWASAKI									
KLF300 BAYOU 89-05	FRONT	12X7	4/136	4+3	0230-0440	0230-0448	0232-0203	0232-0204	0232-0210
	REAR	12X8	4/136	2+6	0230-0442	0230-0450	0232-0203	0232-0204	0232-0210
	FRONT	14X7	4/136	4+3	0230-0456	0230-0464	0232-0203	0232-0204	0232-0210
	REAR	14X8	4/136	2+6	0230-0458	0230-0466	0232-0203	0232-0204	0232-0210
KLF400 BAYOU 93-05	FRONT	12X7	4/136	4+3	0230-0440	0230-0448	0232-0203	0232-0204	0232-0210
	REAR	12X8	4/136	2+6	0230-0442	0230-0450	0232-0203	0232-0204	0232-0210
	FRONT	14X7	4/136	4+3	0230-0456	0230-0464	0232-0203	0232-0204	0232-0210
	REAR	14X8	4/136	2+6	0230-0458	0230-0466	0232-0203	0232-0204	0232-0210
KVF360 PRAIRIE 02-07	FRONT	12X7	4/136	4+3	0230-0440	0230-0448	0232-0203	0232-0204	0232-0210
	REAR	12X8	4/136	2+6	0230-0442	0230-0450	0232-0203	0232-0204	0232-0210
	FRONT	14X7	4/136	4+3	0230-0456	0230-0464	0232-0203	0232-0204	0232-0210
	REAR	14X8	4/136	2+6	0230-0458	0230-0466	0232-0203	0232-0204	0232-0210
KVF400 PRAIRIE 97-06	FRONT	12X7	4/136	4+3	0230-0440	0230-0448	0232-0203	0232-0204	0232-0210
	REAR	12X8	4/136	2+6	0230-0442	0230-0450	0232-0203	0232-0204	0232-0210
	FRONT	14X7	4/136	4+3	0230-0456	0230-0464	0232-0203	0232-0204	0232-0210
	REAR	14X8	4/136	2+6	0230-0458	0230-0466	0232-0203	0232-0204	0232-0210
KVF650/700 PRAIRIE 02-06	FRONT	12X7	4/136	4+3	0230-0440	0230-0448	0232-0203	0232-0204	0232-0210
	REAR	12X8	4/136	2+6	0230-0442	0230-0450	0232-0203	0232-0204	0232-0210
	FRONT	14X7	4/136	4+3	0230-0456	0230-0464	0232-0203	0232-0204	0232-0210
	REAR	14X8	4/136	2+6	0230-0458	0230-0466	0232-0203	0232-0204	0232-0210
BRUTE FORCE 650 4X4 06-08 (STRAIGHT AXLE)	FRONT	12X7	4/136	4+3	0230-0440	0230-0448	0232-0203	0232-0204	0232-0210
	REAR	12X8	4/136	2+6	0230-0442	0230-0450	0232-0203	0232-0204	0232-0210
	FRONT	14X7	4/136	4+3	0230-0456	0230-0464	0232-0203	0232-0204	0232-0210
	REAR	14X8	4/136	2+6	0230-0458	0230-0466	0232-0203	0232-0204	0232-0210
BRUTE FORCE 650I 4X4 06-13 (IRS MODEL)	FRONT	12X7	4/110	4+3	0230-0441	0230-0449	0232-0203	0232-0204	0232-0211

CONTINUED ON NEXT PAGE

PLOWS

WINCHES

UTV

RACKS

LUGGAGE

BODY

CONTROLS

ELECTRICAL

WHEELS & TIRES

SUSPENSION & DRIVE

ENGINE

NRA BY MOOSE

RIDER

TOWING

GARAGE

PROMO

FITS MODEL	POSITION	SIZE	BOLT PATTERN	OFFSET	MACHINED W/ BLACK WHEEL PART#	BLACK WHEEL PART#	LUG NUT CHROME (16-PK) PART #	LUG NUT BLACK (16-PK) PART #	CENTER CAP (4-PK) PART #
387X WHEELS (CON'T)									
KAWASAKI (CON'T)									
BRUTE FORCE 650I 4X4 06-13 (IRS MODEL) (CON'T)	REAR	12X8	4/110	4+4	0230-0446	0230-0454	0232-0203	0232-0204	0232-0211
	FRONT	14X7	4/110	4+3	0230-0457	0230-0465	0232-0203	0232-0204	0232-0211
	REAR	14X8	4/110	4+4	0230-0462	0230-0470	0232-0203	0232-0204	0232-0211
BRUTE FORCE 750 4X4 05-13	FRONT	12X7	4/110	4+3	0230-0441	0230-0449	0232-0203	0232-0204	0232-0211
	REAR	12X8	4/110	4+4	0230-0446	0230-0454	0232-0203	0232-0204	0232-0211
	FRONT	14X7	4/110	4+3	0230-0457	0230-0465	0232-0203	0232-0204	0232-0211
	REAR	14X8	4/110	4+4	0230-0462	0230-0470	0232-0203	0232-0204	0232-0211
TERYX 750 08-13	FRONT	12X7	4/136	4+3	0230-0440	0230-0448	0232-0207	0232-0208	0232-0210
	REAR	12X8	4/136	4+4	0230-0445	0230-0453	0232-0207	0232-0208	0232-0210
	FRONT	14X7	4/136	4+3	0230-0456	0230-0464	0232-0207	0232-0208	0232-0210
	REAR	14X8	4/136	4+4	0230-0461	0230-0469	0232-0207	0232-0208	0232-0210
MULE 550/600/610 ALL YEARS	FRONT	12X7	4/136	4+3	0230-0440	0230-0448	0232-0203	0232-0204	0232-0210
	REAR	12X8	4/136	4+4	0230-0445	0230-0453	0232-0203	0232-0204	0232-0210
MULE 2500/3000/4010 SERIES ALL ¹	FRONT	12X7	4/136	4+3	0230-0440	0230-0448	0232-0207	0232-0208	0232-0210
	REAR	12X8	4/136	4+4	0230-0445	0230-0453	0232-0207	0232-0208	0232-0210
	FRONT	14X7	4/136	4+3	0230-0456	0230-0464	0232-0207	0232-0208	0232-0210
	REAR	14X8	4/136	4+4	0230-0461	0230-0469	0232-0207	0232-0208	0232-0210
KYMCO									
500MX SA 08-10/MXU IE 08-11/500 UXV 10-13	FRONT	12X7	4/110	4+3	0230-0441	0230-0449	0232-0203	0232-0204	0232-0211
	REAR	12X8	4/110	4+4	0230-0446	0230-0454	0232-0203	0232-0204	0232-0211
POLARIS									
SPORTSMAN 335 99-06	FRONT	12X7	4/156	4+3	0230-0439	0230-0447	0232-0205	0232-0206	0232-0210
	REAR	12X8	4/156	4+4	0230-0444	0230-0452	0232-0205	0232-0206	0232-0210
	FRONT	14X7	4/156	4+3	0230-0455	0230-0463	0232-0205	0232-0206	0232-0210
	REAR	14X8	4/156	4+4	0230-0460	0230-0468	0232-0205	0232-0206	0232-0210
SPORTSMAN 400/450 01-10	FRONT	12X7	4/156	4+3	0230-0439	0230-0447	0232-0205	0232-0206	0232-0210
	REAR	12X8	4/156	4+4	0230-0444	0230-0452	0232-0205	0232-0206	0232-0210
	FRONT	14X7	4/156	4+3	0230-0455	0230-0463	0232-0205	0232-0206	0232-0210
	REAR	14X8	4/156	4+4	0230-0460	0230-0468	0232-0205	0232-0206	0232-0210
SPORTSMAN 500 96-08	FRONT	12X7	4/156	4+3	0230-0439	0230-0447	0232-0205	0232-0206	0232-0210
	REAR	12X8	4/156	4+4	0230-0444	0230-0452	0232-0205	0232-0206	0232-0210
	FRONT	14X7	4/156	4+3	0230-0455	0230-0463	0232-0205	0232-0206	0232-0210
	REAR	14X8	4/156	4+4	0230-0460	0230-0468	0232-0205	0232-0206	0232-0210
MAGNUM 500 02-06	FRONT	12X7	4/156	4+3	0230-0439	0230-0447	0232-0205	0232-0206	0232-0210
	REAR	12X8	4/156	4+4	0230-0444	0230-0452	0232-0205	0232-0206	0232-0210
	FRONT	14X7	4/156	4+3	0230-0455	0230-0463	0232-0205	0232-0206	0232-0210
	REAR	14X8	4/156	4+4	0230-0460	0230-0468	0232-0205	0232-0206	0232-0210
SPORTSMAN 600 03-08	FRONT	12X7	4/156	4+3	0230-0439	0230-0447	0232-0205	0232-0206	0232-0210
	REAR	12X8	4/156	4+4	0230-0444	0230-0452	0232-0205	0232-0206	0232-0210
	FRONT	14X7	4/156	4+3	0230-0455	0230-0463	0232-0205	0232-0206	0232-0210
	REAR	14X8	4/156	4+4	0230-0460	0230-0468	0232-0205	0232-0206	0232-0210
SPORTSMAN 700 02-08	FRONT	12X7	4/156	4+3	0230-0439	0230-0447	0232-0205	0232-0206	0232-0210
	REAR	12X8	4/156	4+4	0230-0444	0230-0452	0232-0205	0232-0206	0232-0210
	FRONT	14X7	4/156	4+3	0230-0455	0230-0463	0232-0205	0232-0206	0232-0210
	REAR	14X8	4/156	4+4	0230-0460	0230-0468	0232-0205	0232-0206	0232-0210
SPORTSMAN 800 05-13	FRONT	12X7	4/156	4+3	0230-0439	0230-0447	0232-0205	0232-0206	0232-0210
	REAR	12X8	4/156	4+4	0230-0444	0230-0452	0232-0205	0232-0206	0232-0210
	FRONT	14X7	4/156	4+3	0230-0455	0230-0463	0232-0205	0232-0206	0232-0210
	REAR	14X8	4/156	4+4	0230-0460	0230-0468	0232-0205	0232-0206	0232-0210
RANGER 4X4 03-12	FRONT	12X7	4/156	4+3	0230-0439	0230-0447	0232-0205	0232-0206	0232-0210
	REAR	12X8	4/156	4+4	0230-0444	0230-0452	0232-0205	0232-0206	0232-0210
	FRONT	14X7	4/156	4+3	0230-0455	0230-0463	0232-0205	0232-0206	0232-0210
	REAR	14X8	4/156	4+4	0230-0460	0230-0468	0232-0205	0232-0206	0232-0210
RANGER XP 900 4X4 2013	FRONT	12X7	4/156	4+3	0230-0439	0230-0447	0232-0209	-	0232-0210
	REAR	12X8	4/156	4+4	0230-0444	0230-0452	0232-0209	-	0232-0210
	FRONT	14X7	4/156	4+3	0230-0455	0230-0463	0232-0209	-	0232-0210
	REAR	14X8	4/156	4+4	0230-0460	0230-0468	0232-0209	-	0232-0210
RANGER 400/400EV 10-13	FRONT	12X7	4/156	4+3	0230-0439	0230-0447	0232-0205	0232-0206	0232-0210
	REAR	12X8	4/156	4+4	0230-0444	0230-0452	0232-0205	0232-0206	0232-0210
	FRONT	14X7	4/156	4+3	0230-0455	0230-0463	0232-0205	0232-0206	0232-0210
	REAR	14X8	4/156	4+4	0230-0460	0230-0468	0232-0205	0232-0206	0232-0210
SPORTSMAN XP 550/700/800/850 09-13 ²	FRONT	12X7	4/156	4+3	0230-0439	0230-0447	0232-0203	0232-0204	0232-0210
	REAR	12X8	4/156	4+4	0230-0444	0230-0452	0232-0203	0232-0204	0232-0210
	FRONT	14X7	4/156	4+3	0230-0455	0230-0463	0232-0203	0232-0204	0232-0210
	REAR	14X8	4/156	4+4	0230-0460	0230-0468	0232-0203	0232-0204	0232-0210
RZR AND RZR-S 09-13	FRONT	12X7	4/156	4+3	0230-0439	0230-0447	0232-0205	0232-0206	0232-0210
	REAR	12X8	4/156	4+4	0230-0444	0230-0452	0232-0205	0232-0206	0232-0210
	FRONT	14X7	4/156	4+3	0230-0455	0230-0463	0232-0205	0232-0206	0232-0210
	REAR	14X8	4/156	4+4	0230-0460	0230-0468	0232-0205	0232-0206	0232-0210
SPORTSMAN X2 500/550/800/850 09-13	FRONT	12X7	4/156	4+3	0230-0439	0230-0447	0232-0205	0232-0206	0232-0210
	REAR	12X8	4/156	4+4	0230-0444	0230-0452	0232-0205	0232-0206	0232-0210
	FRONT	14X7	4/156	4+3	0230-0455	0230-0463	0232-0205	0232-0206	0232-0210
	REAR	14X8	4/156	4+4	0230-0460	0230-0468	0232-0205	0232-0206	0232-0210

CONTINUED ON NEXT PAGE

FITS MODEL	POSITION	SIZE	BOLT PATTERN	OFFSET	MACHINED W/ BLACK WHEEL PART#	BLACK WHEEL PART#	LUG NUT CHROME (16-PK) PART #	LUG NUT BLACK (16-PK) PART #	CENTER CAP (4-PK) PART #
387X WHEELS (CON'T)									
SUZUKI									
KING QUAD 400 (STRAIGHT AXLE) 4X4 08-12	FRONT	12X7	4/110	4+3	0230-0441	0230-0449	0232-0203	0232-0204	0232-0211
	REAR	12X8	4/110	2+6	0230-0443	0230-0451	0232-0203	0232-0204	0232-0211
	FRONT	14X7	4/110	4+3	0230-0457	0230-0465	0232-0203	0232-0204	0232-0211
	REAR	14X8	4/110	2+6	0230-0459	0230-0467	0232-0203	0232-0204	0232-0211
VINSON 500 4X4 02-08	FRONT	12X7	4/110	4+3	0230-0441	0230-0449	0232-0203	0232-0204	0232-0211
	REAR	12X8	4/110	2+6	0230-0443	0230-0451	0232-0203	0232-0204	0232-0211
	FRONT	14X7	4/110	4+3	0230-0457	0230-0465	0232-0203	0232-0204	0232-0211
	REAR	14X8	4/110	2+6	0230-0459	0230-0467	0232-0203	0232-0204	0232-0211
EIGER 400 4X4 02-07	FRONT	12X7	4/110	4+3	0230-0441	0230-0449	0232-0203	0232-0204	0232-0211
	REAR	12X8	4/110	2+6	0230-0443	0230-0451	0232-0203	0232-0204	0232-0211
	FRONT	14X7	4/110	4+3	0230-0457	0230-0465	0232-0203	0232-0204	0232-0211
	REAR	14X8	4/110	2+6	0230-0459	0230-0467	0232-0203	0232-0204	0232-0211
KING QUAD 450 05-13	FRONT	12X7	4/110	4+3	0230-0441	0230-0449	0232-0203	0232-0204	0232-0211
	REAR	12X8	4/110	4+4	0230-0446	0230-0454	0232-0203	0232-0204	0232-0211
	FRONT	14X7	4/110	4+3	0230-0457	0230-0465	0232-0203	0232-0204	0232-0211
	REAR	14X8	4/110	4+4	0230-0462	0230-0470	0232-0203	0232-0204	0232-0211
KING QUAD 700/750 05-13	FRONT	12X7	4/110	4+3	0230-0441	0230-0449	0232-0203	0232-0204	0232-0211
	REAR	12X8	4/110	4+4	0230-0446	0230-0454	0232-0203	0232-0204	0232-0211
	FRONT	14X7	4/110	4+3	0230-0457	0230-0465	0232-0203	0232-0204	0232-0211
	REAR	14X8	4/110	4+4	0230-0462	0230-0470	0232-0203	0232-0204	0232-0211
TWIN PEAKS 700 04-07	FRONT	12X7	4/136	4+3	0230-0440	0230-0448	0232-0203	0232-0204	0232-0210
	REAR	12X8	4/136	2+6	0230-0442	0230-0450	0232-0203	0232-0204	0232-0210
	FRONT	14X7	4/136	4+3	0230-0456	0230-0464	0232-0203	0232-0204	0232-0210
	REAR	14X8	4/136	2+6	0230-0458	0230-0466	0232-0203	0232-0204	0232-0210
YAMAHA									
GRIZZLY 350 (STRAIGHT AXLE) 4X4	FRONT	12X7	4/110	4+3	0230-0441	0230-0449	0232-0203	0232-0204	0232-0211
	REAR	12X8	4/110	2+6	0230-0443	0230-0451	0232-0203	0232-0204	0232-0211
	FRONT	14X7	4/110	4+3	0230-0457	0230-0465	0232-0203	0232-0204	0232-0211
	REAR	14X8	4/110	2+6	0230-0459	0230-0467	0232-0203	0232-0204	0232-0211
BIG BEAR 350/400 2X4/4X4 87-06	FRONT	12X7	4/110	4+3	0230-0441	0230-0449	0232-0203	0232-0204	0232-0211
	REAR	12X8	4/110	2+6	0230-0443	0230-0451	0232-0203	0232-0204	0232-0211
	FRONT	14X7	4/110	4+3	0230-0457	0230-0465	0232-0203	0232-0204	0232-0211
	REAR	14X8	4/110	2+6	0230-0459	0230-0467	0232-0203	0232-0204	0232-0211
WOLVERINE 350/450 4X4 95-08	FRONT	12X7	4/110	4+3	0230-0441	0230-0449	0232-0203	0232-0204	0232-0211
	REAR	12X8	4/110	2+6	0230-0443	0230-0451	0232-0203	0232-0204	0232-0211
	FRONT	14X7	4/110	4+3	0230-0457	0230-0465	0232-0203	0232-0204	0232-0211
	REAR	14X8	4/110	2+6	0230-0459	0230-0467	0232-0203	0232-0204	0232-0211
BRUIN 350 2X4/4X4 04-06	FRONT	12X7	4/110	4+3	0230-0441	0230-0449	0232-0203	0232-0204	0232-0211
	REAR	12X8	4/110	2+6	0230-0443	0230-0451	0232-0203	0232-0204	0232-0211
	FRONT	14X7	4/110	4+3	0230-0457	0230-0465	0232-0203	0232-0204	0232-0211
	REAR	14X8	4/110	2+6	0230-0459	0230-0467	0232-0203	0232-0204	0232-0211
GRIZZLY 350 IRS 07-13	FRONT	12X7	4/110	4+3	0230-0441	0230-0449	0232-0203	0232-0204	0232-0211
	REAR	12X8	4/110	4+4	0230-0446	0230-0454	0232-0203	0232-0204	0232-0211
	FRONT	14X7	4/110	4+3	0230-0457	0230-0465	0232-0203	0232-0204	0232-0211
	REAR	14X8	4/110	4+4	0230-0462	0230-0470	0232-0203	0232-0204	0232-0211
KODIAK 400/450 4X4 93-04	FRONT	12X7	4/110	4+3	0230-0441	0230-0449	0232-0203	0232-0204	0232-0211
	REAR	12X8	4/110	2+6	0230-0443	0230-0451	0232-0203	0232-0204	0232-0211
	FRONT	14X7	4/110	4+3	0230-0457	0230-0465	0232-0203	0232-0204	0232-0211
	REAR	14X8	4/110	2+6	0230-0459	0230-0467	0232-0203	0232-0204	0232-0211
GRIZZLY 600 GRIZZLY 4X4 98-01	FRONT	12X7	4/110	4+3	0230-0441	0230-0449	0232-0203	0232-0204	0232-0211
	REAR	12X8	4/110	2+6	0230-0443	0230-0451	0232-0203	0232-0204	0232-0211
	FRONT	14X7	4/110	4+3	0230-0457	0230-0465	0232-0203	0232-0204	0232-0211
	REAR	14X8	4/110	2+6	0230-0459	0230-0467	0232-0203	0232-0204	0232-0211
KODIAK 400/450 4X4 05-06	FRONT	12X7	4/110	4+3	0230-0441	0230-0449	0232-0203	0232-0204	0232-0211
	REAR	12X8	4/110	4+4	0230-0446	0230-0454	0232-0203	0232-0204	0232-0211
	FRONT	14X7	4/110	4+3	0230-0457	0230-0465	0232-0203	0232-0204	0232-0211
	REAR	14X8	4/110	4+4	0230-0462	0230-0470	0232-0203	0232-0204	0232-0211
GRIZZLY 400/450/550/700 4X4 07-13	FRONT	12X7	4/110	4+3	0230-0441	0230-0449	0232-0203	0232-0204	0232-0211
	REAR	12X8	4/110	4+4	0230-0446	0230-0454	0232-0203	0232-0204	0232-0211
	FRONT	14X7	4/110	4+3	0230-0457	0230-0465	0232-0203	0232-0204	0232-0211
	REAR	14X8	4/110	4+4	0230-0462	0230-0470	0232-0203	0232-0204	0232-0211
BIG BEAR 400 IRS 07-12	FRONT	12X7	4/110	4+3	0230-0441	0230-0449	0232-0203	0232-0204	0232-0211
	REAR	12X8	4/110	4+4	0230-0446	0230-0454	0232-0203	0232-0204	0232-0211
	FRONT	14X7	4/110	4+3	0230-0457	0230-0465	0232-0203	0232-0204	0232-0211
	REAR	14X8	4/110	4+4	0230-0462	0230-0470	0232-0203	0232-0204	0232-0211
GRIZZLY 660 02-09	FRONT	12X7	4/110	4+3	0230-0441	0230-0449	0232-0203	0232-0204	0232-0211
	REAR	12X8	4/110	4+4	0230-0446	0230-0454	0232-0203	0232-0204	0232-0211
	FRONT	14X7	4/110	4+3	0230-0457	0230-0465	0232-0203	0232-0204	0232-0211
	REAR	14X8	4/110	4+4	0230-0462	0230-0470	0232-0203	0232-0204	0232-0211
RHINO 450/660/700 04-13	FRONT	12X7	4/110	4+3	0230-0441	0230-0449	0232-0203	0232-0204	0232-0211
	REAR	12X8	4/110	4+4	0230-0446	0230-0454	0232-0203	0232-0204	0232-0211
	FRONT	14X7	4/110	4+3	0230-0457	0230-0465	0232-0203	0232-0204	0232-0211
	REAR	14X8	4/110	4+4	0230-0462	0230-0470	0232-0203	0232-0204	0232-0211

¹ LIFT KIT NEEDED FOR 26" OR LARGER TIRES ² SPORTSMAN XP 2009 IS 5" WIDER WITH AFTER MARKET WHEELS

PLOWS
WINCHES
UTV
RACKS
LUGGAGE
BODY
CONTROLS
ELECTRICAL
WHEELS & TIRES
SUSPENSION & DRIVE
ENGINE
NRA BY MOOSE
RIDER
TOWING
GARAGE
PROMO

MUD.

901K *tire* / 387K *wheel* KITS

901X / 387X TIRE & WHEEL KITS > \$221.95-\$242.95

Kits combine the Moose 901X tires mounted on the stylish and durable 387X wheels. The 901X with its offset V tread design and side lugs offers high performance in mud, snow and sand. 6 ply construction for superior durability and puncture resistance. Lugs are recessed in the center for added surface area for better traction. Pebbled design in between the lugs makes for better clean out between lugs when riding in sticky clay and mud. 387X wheels are 100% X-rayed on the production line to ensure quality and reliability. Wheels handle load capacities from 675 lbs. for the 12x7 front to 1,150 lbs. for the 12x8 rear which meet, or exceed all current market requirements. Front is 26 x 9-12, rears are 26 x 12-12. Available in gloss black or machined finish with chrome center caps and rivets. Center caps are included with each wheel, but lug nuts must be ordered separately. Imported.



FITS MODEL	POSITION	MACHINED W/ BLACK WHEEL		GLOSS BLACK WHEEL		LUG NUT CHROME (16-PK) PART #	LUG NUT BLACK (16-PK) PART #	CENTER CAP (4-PK) PART #
		LEFT PART #	RIGHT PART #	LEFT PART #	RIGHT PART #			
901X TIRE / 387X WHEEL KITS								
CAN-AM								
OUTLANDER 330/400/500/650/800 03-13	FRONT	0331-1153	0331-1154	0331-1167	0331-1168	0232-0203	0232-0204	0232-0210
	REAR	0331-1155	0331-1156	0331-1169	0331-1170	0232-0203	0232-0204	0232-0210
RENEGADE 500/800 09-13	FRONT	0331-1153	0331-1154	0331-1167	0331-1168	0232-0203	0232-0204	0232-0210
	REAR	0331-1155	0331-1156	0331-1169	0331-1170	0232-0203	0232-0204	0232-0210
TRAXTER 4X4 99-06	FRONT	0331-1149	0331-1150	0331-1163	0331-1164	0232-0203	0232-0204	0232-0211
	REAR	0331-1161	0331-1162	0331-1175	0331-1176	0232-0203	0232-0204	0232-0211
QUEST 650 01-06	FRONT	0331-1149	0331-1150	0331-1163	0331-1164	0232-0203	0232-0204	0232-0211
	REAR	0331-1161	0331-1162	0331-1175	0331-1176	0232-0203	0232-0204	0232-0211
COMMANDER 800/1000 11-13	FRONT	0331-1153	0331-1154	0331-1167	0331-1168	0232-0203	0232-0204	0232-0210
	REAR	0331-1155	0331-1156	0331-1169	0331-1170	0232-0203	0232-0204	0232-0210
HONDA								
TRX250 RECON 08-12	FRONT	0331-1149	0331-1150	0331-1163	0331-1164	0232-0203	0232-0204	0232-0211
	REAR	0331-1161	0331-1162	0331-1175	0331-1176	0232-0203	0232-0204	0232-0211
TRX300 FOURTRAX 89-00	FRONT	0331-1149	0331-1150	0331-1163	0331-1164	0232-0203	0232-0204	0232-0211
	REAR	0331-1161	0331-1162	0331-1175	0331-1176	0232-0203	0232-0204	0232-0211
TRX350 RANCHER 00-06	FRONT	0331-1149	0331-1150	0331-1163	0331-1164	0232-0203	0232-0204	0232-0211
	REAR	0331-1161	0331-1162	0331-1175	0331-1176	0232-0203	0232-0204	0232-0211
TRX400 FOREMAN 4X4 96-06	FRONT	0331-1149	0331-1150	0331-1163	0331-1164	0232-0203	0232-0204	0232-0211
	REAR	0331-1161	0331-1162	0331-1175	0331-1176	0232-0203	0232-0204	0232-0211
TRX400/420 RANCHER 04-12	FRONT	0331-1149	0331-1150	0331-1163	0331-1164	0232-0203	0232-0204	0232-0211
	REAR	0331-1161	0331-1162	0331-1175	0331-1176	0232-0203	0232-0204	0232-0211
TRX450/500 FOREMAN S-ES 4X4 98-12	FRONT	0331-1149	0331-1150	0331-1163	0331-1164	0232-0203	0232-0204	0232-0211
	REAR	0331-1161	0331-1162	0331-1175	0331-1176	0232-0203	0232-0204	0232-0211
TRX420AT/500AT RANCHER 09-13'	FRONT	0331-1149	0331-1150	0331-1163	0331-1164	0232-0203	0232-0204	0232-0211
	REAR	0331-1151	0331-1152	0331-1165	0331-1166	0232-0203	0232-0204	0232-0211
TRX500 RUBICON 4X4 01-13	FRONT	0331-1149	0331-1150	0331-1163	0331-1164	0232-0203	0232-0204	0232-0211
	REAR	0331-1161	0331-1162	0331-1175	0331-1176	0232-0203	0232-0204	0232-0211
TRX650/700 RINCON 4X4 02-13	FRONT	0331-1149	0331-1150	0331-1163	0331-1164	0232-0203	0232-0204	0232-0211
	REAR	0331-1151	0331-1152	0331-1165	0331-1166	0232-0203	0232-0204	0232-0211
BIG RED 700 MUV 09-13	FRONT	0331-1149	0331-1150	0331-1163	0331-1164	0232-0209	-	0232-0211
	REAR	0331-1151	0331-1152	0331-1165	0331-1166	0232-0209	-	0232-0211

CONTINUED ON NEXT PAGE

FITS MODEL	POSITION	MACHINED W/ BLACK WHEEL		GLOSS BLACK WHEEL		LUG NUT	LUG NUT	CENTER
		LEFT PART#	RIGHT PART#	LEFT PART#	RIGHT PART#	CHROME (16-PK) PART #	BLACK (16-PK) PART #	CAP (4-PK) PART #
901X TIRE / 387X WHEEL KITS (CON'T)								
KAWASAKI								
BRUTE FORCE 650 I 06-13	FRONT	0331-1149	0331-1150	0331-1163	0331-1164	0232-0203	0232-0204	0232-0211
	REAR	0331-1151	0331-1152	0331-1165	0331-1166	0232-0203	0232-0204	0232-0211
BRUTE FORCE 750 I 05-13	FRONT	0331-1149	0331-1150	0331-1163	0331-1164	0232-0203	0232-0204	0232-0211
	REAR	0331-1151	0331-1152	0331-1165	0331-1166	0232-0203	0232-0204	0232-0211
TERYX 750 08-13	FRONT	0331-1153	0331-1154	0331-1167	0331-1168	0232-0207	0232-0208	0232-0211
	REAR	0331-1155	0331-1156	0331-1169	0331-1170	0232-0207	0232-0208	0232-0211
MULE 2500/3000/4000 SERIES ²	FRONT	0331-1153	0331-1154	0331-1167	0331-1168	0232-0207	0232-0208	0232-0211
	REAR	0331-1155	0331-1156	0331-1169	0331-1170	0232-0207	0232-0208	0232-0211
KYMCO								
375 MXU-IE 08-13	FRONT	0331-1149	0331-1150	0331-1163	0331-1164	0232-0203	0232-0204	0232-0211
	REAR	0331-1151	0331-1152	0331-1165	0331-1166	0232-0203	0232-0204	0232-0211
500MUX SA 08-10	FRONT	0331-1149	0331-1150	0331-1163	0331-1164	0232-0203	0232-0204	0232-0211
	REAR	0331-1151	0331-1152	0331-1165	0331-1166	0232-0203	0232-0204	0232-0211
500UXV 12/500 MXU-IE 10-12	FRONT	0331-1149	0331-1150	0331-1163	0331-1164	0232-0203	0232-0204	0232-0211
	REAR	0331-1151	0331-1152	0331-1165	0331-1166	0232-0203	0232-0204	0232-0211
POLARIS								
SPORTSMAN 335 99-06	FRONT	0331-1157	0331-1158	0331-1171	0331-1172	0232-0205	0232-0206	0232-0210
	REAR	0331-1159	0331-1160	0331-1173	0331-1174	0232-0205	0232-0206	0232-0210
SPORTSMAN 400/450 01-11	FRONT	0331-1157	0331-1158	0331-1171	0331-1172	0232-0205	0232-0206	0232-0210
	REAR	0331-1159	0331-1160	0331-1173	0331-1174	0232-0205	0232-0206	0232-0210
SPORTSMAN 500/550 96-13	FRONT	0331-1157	0331-1158	0331-1171	0331-1172	0232-0205	0232-0206	0232-0210
	REAR	0331-1159	0331-1160	0331-1173	0331-1174	0232-0205	0232-0206	0232-0210
MAGNUM 500 02-06	FRONT	0331-1157	0331-1158	0331-1171	0331-1172	0232-0205	0232-0206	0232-0210
	REAR	0331-1159	0331-1160	0331-1173	0331-1174	0232-0205	0232-0206	0232-0210
SPORTSMAN 600 03-08	FRONT	0331-1157	0331-1158	0331-1171	0331-1172	0232-0205	0232-0206	0232-0210
	REAR	0331-1159	0331-1160	0331-1173	0331-1174	0232-0205	0232-0206	0232-0210
SPORTSMAN 700 02-08	FRONT	0331-1157	0331-1158	0331-1171	0331-1172	0232-0205	0232-0206	0232-0210
	REAR	0331-1159	0331-1160	0331-1173	0331-1174	0232-0205	0232-0206	0232-0210
SPORTSMAN 800/850 05-12	FRONT	0331-1157	0331-1158	0331-1171	0331-1172	0232-0205	0232-0206	0232-0210
	REAR	0331-1159	0331-1160	0331-1173	0331-1174	0232-0205	0232-0206	0232-0210
RZR / RZR S 09-13	FRONT	0331-1157	0331-1158	0331-1171	0331-1172	0232-0205	0232-0206	0232-0211
	REAR	0331-1159	0331-1160	0331-1173	0331-1174	0232-0205	0232-0206	0232-0211
SPORTSMAN 500/550/800 X2 09-13	FRONT	0331-1157	0331-1158	0331-1171	0331-1172	0232-0205	0232-0206	0232-0211
	REAR	0331-1159	0331-1160	0331-1173	0331-1174	0232-0205	0232-0206	0232-0211
RANGER 4X4 & RANGER XP 03-13	FRONT	0331-1157	0331-1158	0331-1171	0331-1172	0232-0205	0232-0206	0232-0210
	REAR	0331-1159	0331-1160	0331-1173	0331-1174	0232-0205	0232-0206	0232-0210
RANGER 900 XP 2013	FRONT	0331-1157	0331-1158	0331-1171	0331-1172	0232-0209	-	0232-0210
	REAR	0331-1159	0331-1160	0331-1173	0331-1174	0232-0209	-	0232-0210
SUZUKI								
KING QUAD 400 08-13	FRONT	0331-1149	0331-1150	0331-1163	0331-1164	0232-0203	0232-0204	0232-0211
	REAR	0331-1161	0331-1162	0331-1175	0331-1176	0232-0203	0232-0204	0232-0211
VINSON 500 4X4 02-08	FRONT	0331-1149	0331-1150	0331-1163	0331-1164	0232-0203	0232-0204	0232-0211
	REAR	0331-1161	0331-1162	0331-1175	0331-1176	0232-0203	0232-0204	0232-0211
EIGER 400 02-07	FRONT	0331-1149	0331-1150	0331-1163	0331-1164	0232-0203	0232-0204	0232-0211
	REAR	0331-1161	0331-1162	0331-1175	0331-1176	0232-0203	0232-0204	0232-0211
KING QUAD 450/500/750 05-13	FRONT	0331-1149	0331-1150	0331-1163	0331-1164	0232-0203	0232-0204	0232-0211
	REAR	0331-1151	0331-1152	0331-1165	0331-1176	0232-0203	0232-0204	0232-0211
YAMAHA								
GRIZZLY 350 4X4 08-13	FRONT	0331-1149	0331-1150	0331-1163	0331-1164	0232-0203	0232-0204	0232-0211
	REAR	0331-1161	0331-1162	0331-1175	0331-1176	0232-0203	0232-0204	0232-0211
GRIZZLY 350 IRS 07-13	FRONT	0331-1149	0331-1150	0331-1163	0331-1164	0232-0203	0232-0204	0232-0211
	REAR	0331-1151	0331-1152	0331-1165	0331-1166	0232-0203	0232-0204	0232-0211
BIG BEAR 350/400 87-06	FRONT	0331-1149	0331-1150	0331-1163	0331-1164	0232-0203	0232-0204	0232-0211
	REAR	0331-1161	0331-1162	0331-1175	0331-1176	0232-0203	0232-0204	0232-0211
WOLVERINE 350/450 95-09	FRONT	0331-1149	0331-1150	0331-1163	0331-1164	0232-0203	0232-0204	0232-0211
	REAR	0331-1161	0331-1162	0331-1175	0331-1176	0232-0203	0232-0204	0232-0211
BRUIN 350 2X4/4X4 04-06	FRONT	0331-1149	0331-1150	0331-1163	0331-1164	0232-0203	0232-0204	0232-0211
	REAR	0331-1161	0331-1162	0331-1175	0331-1176	0232-0203	0232-0204	0232-0211
BIG BEAR 400 07-13	FRONT	0331-1149	0331-1150	0331-1163	0331-1164	0232-0203	0232-0204	0232-0211
	REAR	0331-1151	0331-1152	0331-1165	0331-1166	0232-0203	0232-0204	0232-0211
KODIAK 400/450 4X4 93-04	FRONT	0331-1149	0331-1150	0331-1163	0331-1164	0232-0203	0232-0204	0232-0211
	REAR	0331-1161	0331-1162	0331-1175	0331-1176	0232-0203	0232-0204	0232-0211
KODIAK 400/450 4X4 05-06	FRONT	0331-1149	0331-1150	0331-1163	0331-1164	0232-0203	0232-0204	0232-0211
	REAR	0331-1151	0331-1152	0331-1165	0331-1166	0232-0203	0232-0204	0232-0211
GRIZZLY 600 4X4 98-01	FRONT	0331-1149	0331-1150	0331-1163	0331-1164	0232-0203	0232-0204	0232-0211
	REAR	0331-1161	0331-1162	0331-1175	0331-1176	0232-0203	0232-0204	0232-0211
GRIZZLY 400/450/550/700 07-13	FRONT	0331-1149	0331-1150	0331-1163	0331-1164	0232-0203	0232-0204	0232-0211
	REAR	0331-1151	0331-1152	0331-1165	0331-1166	0232-0203	0232-0204	0232-0211
GRIZZLY 660 02-09	FRONT	0331-1149	0331-1150	0331-1163	0331-1164	0232-0203	0232-0204	0232-0211
	REAR	0331-1151	0331-1152	0331-1165	0331-1166	0232-0203	0232-0204	0232-0211
RHINO 450/660/700 04-13	FRONT	0331-1149	0331-1150	0331-1163	0331-1164	0232-0203	0232-0204	0232-0211
	REAR	0331-1151	0331-1152	0331-1165	0331-1166	0232-0203	0232-0204	0232-0211

¹ INDEPENDENT REAR SUSPENSION

² REQUIRES A LIFT KIT

PLOWS
WINCHES
UTV
RACKS
LUGGAGE
BODY
CONTROLS
ELECTRICAL
WHEELS & TIRES
SUSPENSION & DRIVE
ENGINE
NRA BY MOOSE
RIDER
TOWING
GARAGE
PROMO

M.U.D.





- PROMO
- GARAGE
- TOWING
- RIDER
- NRA BY MOOSE
- ENGINE
- SUSPENSION & DRIVE**
- WHEELS & TIRES
- ELECTRICAL
- CONTROLS
- BODY
- LUGGAGE
- RACKS
- UTV
- WINCHES
- PLOWS

BALL JOINT AND KING PIN KITS > \$18.95-\$52.95

Ball Joint kits offer a considerable cost savings over OEM. Steel housing on some applications replace aluminum joints standard on OEM parts. POM-M90 bearing cup isolates steel rod from housing. OEM does not supply replacement ball joints on many applications. King pin kits are for smaller ATVs where ball joints are not used. Bearings are all hardened steel. Made in the USA.



FITS MODEL	BALL JOINT LOWER PART #	BALL JOINT UPPER PART #	KING PIN KIT PART #
BALL JOINT & KING PIN KITS			
ARCTIC CAT			
250 2X4 99-05	0430-0456	0430-0456	-
250 4X4 01-05	0430-0456	0430-0456	-
300 2X4 98-04	0430-0456	0430-0456	-
300 4X4 98-05	0430-0456	0430-0456	-
350 UTILITY 4X4 11	0430-0456	0430-0456	-
366 FIS W/AT 08-11	0430-0456	0430-0456	-
375 2X4 W/AT 02	0430-0456	0430-0456	-
375 4X4 W/AT 02	0430-0456	0430-0456	-
400 2X4 98-01	0430-0456	0430-0456	-
400 2X4 FIS W/AT 03-04	0430-0456	0430-0456	-
400 2X4 FIS W/MT 03-04	0430-0456	0430-0456	-
400 4X4 98-00	0430-0456	0430-0456	-
400 4X4 W/AT 03-04	0430-0456	0430-0456	-
400 4X4 W/MT 01-04	0430-0456	0430-0456	-
400 DVX 04-08	-	0430-0265	-
400 FIS 4X4 TRV 09-11	0430-0456	0430-0456	-
400 FIS 4X4 W/AT 03-08	0430-0456	0430-0456	-
400 FIS 4X4 W/MT 02-08	0430-0456	0430-0456	-
400 TBX 4X4 04-06	0430-0456	0430-0456	-
400 TRV 07	0430-0456	0430-0456	-
400 VP 4X4 06	0430-0456	0430-0456	-
425 UTILITY 4X4 11	0430-0456	0430-0456	-
425I 4X4 12	0430-0456	0430-0456	-
450 HI 10-11	0430-0456	0430-0456	-
450I EFI 12	0430-0456	0430-0456	-
450I TRV EFI 12	0430-0456	0430-0456	-
450XC 4X4 11	0430-0456	0430-0456	-
454 2X4 97-98	0430-0456	0430-0456	-
454 4X4 96-98	0430-0456	0430-0456	-
500 4X4 98-99	0430-0456	0430-0456	-
500 4X4 W/AT 00-02	0430-0456	0430-0456	-
500 4X4 W/MT 00-01	0430-0456	0430-0456	-
500 FIS 4X4 W/AT 02-09	0430-0456	0430-0456	-
500 FIS 4X4 W/MT 02	0430-0456	0430-0456	-
500 FIS 4X4 W/MT 04-09	0430-0456	0430-0456	-
500 FIS TBX 4X4 02-06	0430-0456	0430-0456	-
500 FIS TRV 4X4 03-06	0430-0456	0430-0456	-
500 FIS TRV 4X4 08	0430-0456	0430-0456	-
550 GT EFI 4X4 12	0430-0456	0430-0456	-
550 HI FIS 4X4 09-11	0430-0456	0430-0456	-
550 I EFI 4X4 12	0430-0456	0430-0456	-
550 TRV 4X4 W/AT 09-11	0430-0456	0430-0456	-
550I TRV GT EFI 4X4 12	0430-0456	0430-0456	-
550 PROWLER XT 09-13	0430-0456	0430-0456	-
650 4X4 HI 05-11	0430-0456	0430-0456	-
650 4X4 HI MUD PRO 10-11	0430-0456	0430-0456	-
650 4X4 W/AT V2 04-06	0430-0456	0430-0456	-
650I 4X4 12	0430-0456	0430-0456	-
650 PROWLER XT 06-09	0430-0456	0430-0456	-
700 DIESEL 08-11	0430-0456	0430-0456	-
700 EFI 4X4 07-12	0430-0456	0430-0456	-
700 EFI HI MUDPRO 09-12	0430-0456	0430-0456	-
700 EFI HI W/AT 08-11	0430-0456	0430-0456	-
700 GT EFI 12	0430-0456	0430-0456	-
700 HI TRV 08-11	0430-0456	0430-0456	-
700I TRV GT EFI 12	0430-0456	0430-0456	-
700 PROWLER HDX 12	0430-0456	0430-0456	-
700 PROWLER XTX 08-12	0430-0456	0430-0456	-
1000I GT 12	0430-0456	0430-0456	-
H2 MUDPRO 10-11	0430-0456	0430-0456	-
H2 THUNDERCAT 08-11	0430-0456	0430-0456	-
1000 PROWLER XTX 11-12	0430-0456	0430-0456	-
PROWLER H2 1000 XTX 09-13	0430-0456	0430-0456	-

FITS MODEL	BALL JOINT LOWER PART #	BALL JOINT UPPER PART #	KING PIN KIT PART #
BALL JOINT & KING PIN KITS (CON'T)			
CAN-AM			
OUTLANDER 330 04-05	-	0430-0562	-
OUTLANDER 400 03-05	-	0430-0562	-
OUTLANDER 400 06-13	0430-0606	0430-0562	-
OUTLANDER 500 07-13	0430-0606	0430-0562	-
OUTLANDER 500 PSTEERING 10-13	0430-0606	0430-0562	-
QUEST 500 02-03	0430-0605	0430-0605	-
RENEGADE 500 08-13	0430-0605	0430-0605	-
RENEGADE 500 PSTEERING 12-13	0430-0605	0430-0605	-
TRAXTER 500 99-05	0430-0605	0430-0605	-
OUTLANDER 650 07-13	0430-0606	0430-0605	-
OUTLANDER 650 PSTEERING 10-13	0430-0606	0430-0605	-
QUEST 650 02-04	0430-0605	0430-0605	-
TRAXTER 650 04-05	0430-0605	0430-0605	-
OUTLANDER 800 06-13	0430-0606	0430-0605	-
OUTLANDER 800 PSTEERING 10-13	0430-0606	0430-0605	-
OUTLANDER STD XT 800 12	0430-0664	-	-
RENEGADE 800 07-11	0430-0605	0430-0605	-
RENEGADE 800 XXC 12-13	0430-0664	-	-
RENEGADE 800 PSTEERING 10-11	0430-0605	0430-0605	-
OUTLANDER STD XT 1000 12-13	0430-0664	-	-
RENEGADE 1000 XXC 12-13	0430-0664	-	-
COMMANDER 800 11-13	0430-0664	-	-
COMMANDER 1000 11-13	0430-0664	-	-
HONDA			
TRX125 87-88	-	-	0430-0258
TRX200 90-91	-	-	0430-0259
TRX200 96-97	-	-	0430-0259
TRX200D 90-97	-	-	0430-0259
TRX200SX 86-88	-	-	0430-0256
TRX250 RECON 97-13	0430-0254	0430-0255	-
TRX300 FOURTRAX 300 88-92	-	0430-0308	-
TRX300 FOURTRAX 300 93-00	0430-0255	0430-0255	-
TRX300FW FOURTRAX 4X4 88-00	0430-0255	0430-0255	-
TRX350FE/FM/TE/TM 00-06	0430-0255	0430-0261	-
TRX400FA/FGA 04-07	0430-0255	0430-0261	-
TRX400FW FOURTRAX FOREMAN 4X4 95-03	0430-0255	0430-0255	-
TRX420FA 09-12	0430-0255	0430-0261	-
TRX420FE/FM 07-13	0430-0255	0430-0261	-
TRX420FPA 09-13	0430-0255	0430-0261	-
TRX420FPE 11-13	0430-0255	0430-0261	-
TRX420FPM 11-13	0430-0255	0430-0261	-
TRX420TE/TM 07-10	0430-0255	0430-0261	-
TRX450ES 98-01	0430-0261	0430-0261	-
TRX450FE/FM 02-04	0430-0261	0430-0261	-
TRX450S 98-01	0430-0261	0430-0261	-
TRX500FA 01-12	0430-0261	0430-0261	-
TRX500FE/FM 05-13	0430-0261	0430-0261	-
TRX500FGA 04-09	0430-0261	0430-0261	-
TRX500FPA 09-13	0430-0261	0430-0261	-
TRX500FPE/FPM 08-12	0430-0261	0430-0261	-
TRX500TM 05-06	0430-0261	0430-0261	-
TRX650 RINCON 03-05	0430-0261	0430-0261	-
TRX680 RINCON 06-13	0430-0261	0430-0261	-
KAWASAKI			
KLF220 BAYOU 88-02	-	-	0430-0257
KLF250 BAYOU 03	-	-	0430-0257
KEF300 LAKOTA 95-03	0430-0262	0430-0263	-
KLF300A BAYOU 86-87	0430-0264	0430-0264	-
KLF300B BAYOU 88-04	0430-0264	0430-0264	-
KLF300C BAYOU 4X4 89-04	0430-0262	0430-0263	-
KVF300A PRAIRIE 4X4 99-00	0430-0262	0430-0562	-
KVF300A PRAIRIE 4X4 01-02	0430-0266	0430-0562	-
KVF300B PRAIRIE 2X4 99-00	0430-0262	0430-0562	-
KVF300B PRAIRIE 2X4 01-02	0430-0266	0430-0562	-
KVF360A & C PRAIRIE 4X4 03-13	0430-0308	0430-0562	-
KVF360B PRAIRIE 03-10	0430-0308	0430-0562	-
KLF400 BAYOU 93-99	0430-0262	0430-0263	-
KVF400A PRAIRIE 4X4 97-98	0430-0262	0430-0562	-
KVF400B PRAIRIE 98	0430-0262	0430-0562	-
KVF400C PRAIRIE 4X4 99-00	0430-0262	0430-0562	-
KVF400C PRAIRIE 4X4 01-02	0430-0266	0430-0562	-
KVF400D PRAIRIE 99-00	0430-0262	0430-0562	-
KVF400D PRAIRIE 01-02	0430-0266	0430-0562	-
MULE 600 05-12	0430-0663	-	-

CONTINUED ON NEXT PAGE

FITS MODEL	BALL JOINT LOWER PART #	BALL JOINT UPPER PART #	KING PIN KIT PART #
BALL JOINT & KING PIN KITS (CON'T)			
KAWASAKI (CON'T)			
MULE 610 4X4 05-08	0430-0663	-	-
MULE 610 4X4 10-13	0430-0663	-	-
MULE 610 4X4 VIN JK1AFE1 9B547191 AND LOWER 09	0430-0663	-	-
MULE 610 4X4 VIN JK1AFE1 9B547192 AND ABOVE 09	0430-0663	-	-
MULE 2500 94-95	0430-0663	-	-
MULE 2500 97-00	0430-0663	-	-
MULE 2510 4X4 93	0430-0663	-	-
MULE 2510 4X4 95	0430-0663	-	-
MULE 2510 4X4 97-00	0430-0663	-	-
MULE 2520 93	0430-0663	-	-
MULE 2520 95	0430-0663	-	-
MULE 2520 97-00	0430-0663	-	-
MULE 3000 01-08	0430-0663	-	-
MULE 3010 4X4 01-08	0430-0663	-	-
MULE 3020 01-03	0430-0663	-	-
MULE 4000 09-13	0430-0663	-	-
MULE 4010 4X4 09-13	0430-0663	-	-
KVF650 BRUTE FORCE 05-12	0430-0308	0430-0562	-
KVF650 I BRUTE FORCE 06-13	0430-0308	0430-0308	-
KVF650 PRAIRIE 02-03	0430-0308	0430-0562	-
KFX700 V-FORCE 04-09	0430-0308	0430-0308	-
KVF700 PRAIRIE 04-06	0430-0308	0430-0562	-
KVF750 BRUTE FORCE 05-13	0430-0308	0430-0308	-
KVF750 BRUTE FORCE EPS 13	0430-0308	0430-0308	-
TERYX 750 4X4 08-13	0430-0308	0430-0308	-
MULE 2510 DIESEL 00-02	0430-0308	-	-
MULE 3010 DIESEL 03	0430-0308	-	-
MULE 3010 DIESEL 06	0430-0308	-	-
MULE 4010 4X4 DIESEL 10	0430-0663	-	-
MULE 4010 4X4 DIESEL 11-12	0430-0308	-	-
POLARIS			
PHOENIX 200 05-13	0430-0273	0430-0273	-
SAWTOOTH 200 07	0430-0273	0430-0273	-
TRAIL BLAZER 250 90-99	0430-0272	-	-
TRAIL BLAZER 250 00-06	0430-0272	-	-
TRAIL BOSS 250 88-93	0430-0272	-	-
TRAIL BOSS 250 4X4 89-93	0430-0272	-	-
XPLORER 250 4X4 00-02	0430-0272	-	-
BIG BOSS 250 4X6 89-92	0430-0272	-	-
BIG BOSS 250 6X6 91-93	0430-0272	-	-
300 2X4 94-95	0430-0272	-	-
300 4X4 94	0430-0272	-	-
HAWKEYE 2X4 06-11	0430-0563	-	-
HAWKEYE 4X4 06-07	0430-0563	-	-
SPORTSMAN 300 4X4 08-10	0430-0563	-	-
TRAIL BOSS 300 4X4 95	0430-0272	-	-
XPLORER 300 4X4 96-99	0430-0272	-	-
XPRESS 300 96-99	0430-0272	-	-
BIG BOSS 300 6X6 94	0430-0272	-	-
MAGNUM 325 2X4/4X4 00-02	0430-0272	-	-
MAGNUM 325 4X4 HDS 01-02	0430-0272	-	-
TRAIL BOSS 325 00-02	0430-0272	-	-
XPEDITION 325 00-02	0430-0272	-	-
ATP 330 4X4 04-05	0430-0272	-	-
MAGNUM 330 2X4/4X4 03-05	0430-0272	-	-
TRAIL BLAZER 330 08-13	0430-0272	-	-
TRAIL BOSS 330 03-13	0430-0272	-	-
SPORTSMAN 335 99-00	0430-0272	-	-
WORKER 335 1999	0430-0272	-	-
350L 2X4/2X4 93	0430-0272	-	-
SPORTSMAN 350 4X4 93	0430-0272	-	-
TRAIL BOSS 350L 2X4 90-92	0430-0272	-	-
TRAIL BOSS 350L 4X4 90-92	0430-0272	-	-
BIG BOSS 350L 6X6 93	0430-0272	-	-
SCRAMBLER 380 2X4 00	0430-0272	-	-
400L 2X4 94-95	0430-0272	-	-
400L 4X4 94	0430-0272	-	-
SPORTSMAN 400 4X4 94-97	0430-0272	-	-
SPORTSMAN 400 4X4 01-05	0430-0272	-	-
SPORTSMAN 400 HO 4X4 08-10	0430-0563	-	-
SPORTSMAN 400 HO 4X4 11-13	0430-0272	-	-
TRAIL BLAZER 400 03	0430-0272	-	-

FITS MODEL	BALL JOINT LOWER PART #	BALL JOINT UPPER PART #	KING PIN KIT PART #
BALL JOINT & KING PIN KITS (CON'T)			
POLARIS (CON'T)			
XPLORER 400L 4X4 95-99	0430-0272	-	-
XPLORER 400L 4X4 00-02	0430-0272	-	-
XPRESS 400L 2X4 96-97	0430-0272	-	-
BIG BOSS 400L 6X6 94-97	0430-0272	-	-
MAGNUM 400L 6X6 96-97	0430-0272	-	-
RANGER 4X4 400 10-12	0430-0272	-	-
MAGNUM 425 2X4 95-98	0430-0272	-	-
MAGNUM 425 4X4 98	0430-0272	-	-
XPEDITION 425 00-02	0430-0272	-	-
SPORTSMAN 450 06-07	0430-0272	-	-
DIESEL 455 4X4 99-01	0430-0272	-	-
MAGNUM 500 2X4 HDS 02	0430-0272	-	-
MAGNUM 500 4X4 99-02	0430-0272	-	-
MAGNUM 500 4X4 HDS 01-03	0430-0272	-	-
SPORTSMAN 500 4X4 96-98	0430-0272	-	-
SPORTSMAN 500 4X4 00	0430-0272	-	-
SPORTSMAN 500 4X4 99	0430-0272	-	-
SPORTSMAN 500 4X4 HO 01-03	0430-0272	-	-
SPORTSMAN 500 4X4 HO 05-08	0430-0272	-	-
SPORTSMAN 500 4X4 HO 04	0430-0272	-	-
SPORTSMAN 500 EFI 09-10	0430-0272	-	-
SPORTSMAN 500 HO 08-12	0430-0272	-	-
SPORTSMAN 500 X2 06-09	0430-0272	-	-
SPORTSMAN TOURING 500 EFI 08-12	0430-0272	-	-
XPLORER 500 97	0430-0272	-	-
BIG BOSS 500 6X6 98-99	0430-0272	-	-
BIG BOSS 500 6X6 00-03	0430-0272	-	-
SPORTSMAN 500 6X6 00-08	0430-0272	-	-
SPORTSMAN 550 12-13	0430-0563	0430-0563	-
SPORTSMAN 550 EPS 10-12	0430-0563	0430-0563	-
SPORTSMAN 550 X2 10	0430-0563	0430-0563	-
SPORTSMAN 550 X2 12-13	0430-0563	0430-0563	-
SPORTSMAN 550 X2 11	0430-0563	0430-0563	-
SPORTSMAN TOURING EPS 550 11-12	0430-0563	0430-0563	-
XP 550 09	0430-0563	0430-0563	-
SPORTSMAN 600 4X4 03-05	0430-0272	-	-
SPORTSMAN 700 4X4 02-04	0430-0272	-	-
SPORTSMAN 700 TWIN EFI, SPORTSMAN 700 TWIN 05	0430-0272	-	-
SPORTSMAN 700 TWIN, SPORTSMAN 700 TWIN EFI 06-07	0430-0272	-	-
SPORTSMAN MV7 05	0430-0272	-	-
SPORTSMAN X2 700 TWIN EFI 08	0430-0272	-	-
SPORTSMAN 800 EFI 05-13	0430-0272	-	-
SPORTSMAN TOURING 800 EFI 08-09	0430-0272	-	-
SPORTSMAN X2 800 EFI 07-09	0430-0272	-	-
SPORTSMAN 800 EFI 6X6 09-12	0430-0272	-	-
SPORTSMAN TOURING EPS 850 10-12	0430-0563	0430-0563	-
SPORTSMAN X2 850 11	0430-0563	0430-0563	-
SPORTSMAN XP 850 09	0430-0563	0430-0563	-
SPORTSMAN XP 850 EPS 10-12	0430-0563	0430-0563	-
RANGER 4X4 800 EFI 11	0430-0563	0430-0563	-
RANGER 4X4 800 EFI CREW 10-12	0430-0563	0430-0563	-
RANGER 6X6 800 10-12	0430-0563	0430-0563	-
RANGER XP 800 12	0430-0563	0430-0563	-
RANGER 4X4 700 05-06	0430-0272	-	-
RANGER 4X4 700 07-08	0430-0272	-	-
RANGER 4X4 700 09	0430-0563	0430-0563	-
RANGER 4X4 700 CREW 08-09	0430-0272	-	-
RANGER 6X6 700 EFI 06-09	0430-0272	-	-
RANGER 4X4 CREW DIESEL 900 11	0430-0563	0430-0563	-
RANGER 4X4 DIESEL 900 11-12	0430-0563	0430-0563	-
RANGER 2X4 500 08-09	0430-0272	-	-
RANGER 4X4 500 99	0430-0272	-	-
RANGER 4X4 500 04-08	0430-0272	-	-
RANGER 4X4 500 09-10	0430-0563	0430-0563	-
RANGER 4X4 500 11-12	0430-0272	-	-
RANGER 6X6 500 02	0430-0272	-	-
RANGER 6X6 500 04	0430-0272	-	-
RANGER SERIES 10-11 4X4 & 6X6 07	0430-0272	-	-
RZR 570 EFI 12	0430-0563	0430-0563	-
RZR 4/EPS RGE 11	0430-0563	0430-0563	-
RZR S 800 09-12	0430-0563	0430-0563	-
RZR 800 08-09	0430-0563	0430-0563	-

CONTINUED ON NEXT PAGE

PLOWS
WINCHES
UTV
RACKS
LUGGAGE
BODY
CONTROLS
ELECTRICAL
WHEELS & TIRES
SUSPENSION & DRIVE
ENGINE
NRA BY MOOSE
RIDER
TOWING
GARAGE
PROMO

FITS MODEL	BALL JOINT LOWER PART #	BALL JOINT UPPER PART #	KING PIN KIT PART #
BALL JOINT & KING PIN KITS (CON'T)			
POLARIS (CON'T)			
RZR 800 10-12	0430-0563	0430-0563	-
RANGER RZR XP 900 11-13	0430-0563	0430-0563	-
SUZUKI			
LT-80 87-06	-	-	0430-0251
LT-125 83-87	-	-	0430-0253
LT-160 03-04	-	-	0430-0253
LT-160E 89-92	-	-	0430-0253
LT-F160 91-01	-	-	0430-0253
LT-185 84-87	-	-	0430-0253
LT-230E 87-93	0430-0267	0430-0268	-
LT-230GE 85-86	0430-0267	0430-0269	-
LT-230S 85-88	0430-0267	0430-0268	-
LT-F230 86-87	0430-0267	0430-0269	-
LT-250EF 85-86	0430-0267	0430-0269	-
LT-250S 89-90	-	0430-0268	-
LT-4WD 250 87-98	0430-0267	0430-0267	-
LT-F250 88-98	0430-0267	0430-0267	-
LT-F250 OZARK 02-04	-	0430-0561	-
LT-F250 OZARK 05-12	-	0430-0265	-
LT-F250, LT-F250F (EXCEPT OZARK) 99-01	0430-0267	0430-0267	-
LT-F250F (EXCEPT OZARK) 02	0430-0267	0430-0267	-
LT-F4WD 250 97-98	0430-0267	0430-0267	-
LT-300E 87-89	0430-0267	0430-0269	-
LT-F300F KING QUAD 99-02	0430-0267	0430-0267	-
LT-F4WD KING QUAD 300 91-98	0430-0267	0430-0267	-
LT-A400 2WD KING QUAD 08-09	0430-0270	0430-0270	-
LT-A400 EIGER 2WD 02-04	0430-0270	0430-0270	-
LT-A400 EIGER 2WD 07	0430-0270	0430-0270	-
LT-A400F EIGER 4WD 02-07	0430-0270	0430-0270	-
LT-F400 2WD KING QUAD 08-12	0430-0270	0430-0270	-
LT-F400F 4WD KING QUAD 08-12	0430-0270	0430-0270	-
LTA-450 X KING QUAD 07-10	0430-0265	0430-0265	-
LT-A500F QUAD MASTER AUTO 00-01	0430-0267	-	-
LT-A500F VINSON 02-07	0430-0270	0430-0270	-
LT-A500X 09-12	0430-0265	0430-0265	-
LT-F500F QUAD RUNNER 98-01	0430-0267	-	-
LT-F500F VINSON 02	0430-0267	-	-
LT-F500F VINSON 03-07	0430-0270	0430-0270	-
LTA-700 X KING QUAD 05-07	0430-0265	0430-0265	-
LTV-700F TWIN PEAKS 04-06	0430-0308	0430-0562	-
LTA-750 X KING QUAD 08-12	0430-0265	0430-0265	-
YAMAHA			
YFM80 BADGER 92-01	-	-	0430-0248
YFM80 GRIZZLY 05-08	-	-	0430-0248
YFM100 89-91	-	-	0430-0248
YFA1 91-04	-	-	0430-0248
YFM125 GRIZZLY 04-13	-	-	0430-0248
YFM200 MOTO-4 85-89	-	-	0430-0249
YFM225 MOTO-4 86-88	-	-	0430-0249
YFB250 TIMBERWOLF 92-98	-	0430-0562	-
YFB250FW TIMBERWOLF 94-00	-	0430-0562	-
YFM250 BEARTRACKER 99-04	-	0430-0562	-
YFM250 BIG BEAR 07-09	-	0430-0562	-
YFM250B BRUIN 05-06	-	0430-0562	-
YFM250 MOTO-4 89-91	-	-	0430-0250
YFM350 GRIZZLY IRS 07-11	0430-0255	0430-0255	-
YFM350BA BRUIN 2WD/4WD 04-06	0430-0255	0430-0255	-
YFM350FEW GRIZZLY 4WD 07-12	0430-0255	0430-0255	-
YFM350GW GRIZZLY 2WD 07-11	0430-0255	0430-0255	-
YFM35X WOLVERINE 06-09	0430-0255	0430-0255	-
YFM350ER MOTO-4 87-88	-	-	0430-0249
YFM350ER MOTO-4 89-95	-	-	0430-0250
YFM400 BIG BEAR 2WD 00-04	0430-0255	0430-0255	-
YFM400 BIG BEAR 4WD 00-06	0430-0255	0430-0255	-
YFM400 BIG BEAR IRS 07-12	0430-0255	0430-0255	-
YFM400 GRIZZLY IRS 07-08	0430-0255	0430-0255	-
YFM400 KODIAK 2WD 03-04	0430-0255	0430-0255	-
YFM400 KODIAK 4WD 03-06	0430-0255	0430-0255	-
YFM450 GRIZZLY IRS 07-13	0430-0255	0430-0255	-
YFM450 KODIAK 03-06	0430-0255	0430-0255	-
YFM450FX WOLVERINE 4X4 06-10	0430-0255	0430-0255	-
YFM550 GRIZZLY 09-12	0430-0604	0430-0271	-
YFM600 GRIZZLY 98-01	-	0430-0562	-
YFM600 GRIZZLY 02	0430-0309	-	-

FITS MODEL	BALL JOINT LOWER PART #	BALL JOINT UPPER PART #	KING PIN KIT PART #
BALL JOINT & KING PIN KITS (CON'T)			
YAMAHA (CON'T)			
YFM660 GRIZZLY 02-08	0430-0309	-	-
YFM700 GRIZZLY 07	0430-0604	0430-0271	-
YFM700 GRIZZLY EPS 10	0430-0604	0430-0271	-
YFM700 GRIZZLY 08-09	0430-0604	0430-0271	-
YFM700 GRIZZLY 11-13	0430-0604	0430-0271	-
RHINO 450 06-09	0430-0255	0430-0255	-
RHINO 660 04-07	0430-0255	0430-0255	-
RHINO 700 08-13	0430-0255	0430-0255	-



FRONT

CV HALFSHAFTS > \$177.95-\$218.95

Heavy-duty fully assembled outboard joint and boot assembly. Includes axle bar, inboard puncture resistant boot, clamps and grease. Polaris halfshafts include axle bar, inboard universal joint and yoke assembly. Made in the USA.

FITS MODEL	LEFT HAND AXLE PART #	RIGHT HAND AXLE PART #
FRONT CV HALFSHAFTS		
ARCTIC CAT		
250 01 4X4 18 TEETH ON BAR	-	0214-0269
250 02-04 4X4	0214-0715	0214-0715
300 98-00 4X4	-	0214-0269
300 01 4X4 18 TEETH ON BAR	-	0214-0269
300 02-04 4X4	0214-0715	0214-0715
375 02 4X4	0214-0715	0214-0715
400 98-00 4X4	0214-0269	0214-0269
400 01 4X4 18 TEETH ON BAR	-	0214-0269
400 02-04 4X4 W/ FIS	0214-0267	0214-0267
400 02-04 4X4 EXC. FIS MACHINES WITH FULLY INDEPENDENT SUSPENSION	0214-0715	0214-0715
400 05 4X4 EXC. VALUE PACKAGE	0214-0268	0214-0268
400 06 4X4 EXC. VALUE PACKAGE	0214-0347	0214-0347
400 07-08 4X4	0214-0347	0214-0347
454 98 4X4 FROM #13001	0214-0269	0214-0269
500 98-99 4X4	0214-0269	0214-0269
500 00 4X4	-	0214-0269
500 01 4X4 18 TEETH ON BAR	-	0214-0269
500 02 4X4 W/ FIS	0214-0267	0214-0267
500 02 4X4 EXC. FIS MACHINES WITH FULLY INDEPENDENT SUSPENSION	0214-0715	0214-0715
500 03-04 4X4	0214-0267	0214-0267
500 05 4X4	0214-0268	0214-0268
500 06-08 4X4	0214-0347	0214-0347
650 04 4X4	0214-0267	0214-0267
650 05 4X4	0214-0268	0214-0268
650 06-08 4X4 EXC. PROWLER XT	0214-0347	0214-0347
650 06-08 4X4 PROWLER XT	0214-0346	0214-0346
700 07-08 4X4	0214-0347	0214-0347
CAN-AM		
OUTLANDER 330 04-05 4X4	0214-0534	0214-0534
OUTLANDER 400 06-08 4X4	0214-0535	0214-0535
OUTLANDER 400 03-05 4X4	0214-0534	0214-0534
OUTLANDER 500 07-08 4X4	0214-0535	0214-0535
OUTLANDER 650 06-08 4X4	0214-0535	0214-0535
OUTLANDER 800 06-08 4X4	0214-0535	0214-0535
QUEST 500 02-04 4X4	0214-0608	0214-0608
QUEST 650 02-04 4X4	0214-0608	0214-0608
RENEGADE 500 08 4X4	0214-0535	0214-0535
RENEGADE 800 07-08 4X4	0214-0535	0214-0535
TRAXTER 02-05 4X4	0214-0608	0214-0608
TRAXTER 01 4X4-7459/7460/7461/7468/7472/7481	0214-0608	0214-0608
TRAXTER 01 4X4-AUTOSHIFT-EXC. 7431/7432	0214-0608	0214-0608
TRAXTER 01 4X4-FOOTSHIFT 7473/7474	0214-0608	0214-0608
TRAXTER 01 4X4-XL 7448-FROM SERIAL NO. V000709	0214-0608	0214-0608
TRAXTER 01 4X4-XL 7467/7468/7472/7481/7489	0214-0608	0214-0608
HONDA		
TRX300 FOURTRAX 93-00 4X4	0214-0151	0214-0151
TRX300 FOURTRAX 88-92 4X4	0214-0105	0214-0105
TRX350 RANCHER 06 4X4	0214-0592	0214-0592
TRX350 RANCHER 00-05 4X4	0214-0152	0214-0152

CONTINUED ON NEXT PAGE

FITS MODEL	LEFT HAND AXLE PART #	RIGHT HAND AXLE PART #
FRONT CV HALFSHAFTS (CON'T)		
HONDA (CON'T)		
TRX400 FOREMAN 95-01 4X4	-	0214-0105
TRX420 RANCHER ES 07-08 4X4	0214-0593	0214-0593
TRX450 FOREMAN 98-04 4X4	0214-0148	0214-0155
TRX500 FOREMAN 08 4X4	0214-0530	0214-0531
TRX500 FOREMAN 07 4X4-EXC. ES W/ POWER STEERING	0214-0397	0214-0398
TRX500 FOREMAN 07 4X4 -ES W/ POWER STEERING	0214-0530	0214-0531
TRX500 FOREMAN 05-06 4X4	0214-0397	0214-0398
TRX500 RUBICON 08 4X4	0214-0530	0214-0531
TRX500 RUBICON 05-07 4X4	0214-0397	0214-0398
TRX500 RUBICON 01-04 4X4	0214-0158	0214-0159
TRX650 RINCON 05 4X4	0214-0397	0214-0398
TRX650 RINCON 03-04 4X4	0214-0158	0214-0159
TRX680 RINCON 08 4X4	0214-0530	0214-0531
TRX680 RINCON 06-07 4X4	0214-0397	0214-0398
JOHN DEERE		
BUCK 04-06 4X4	0214-0608	0214-0608
KAWASAKI		
PRAIRIE 300 99-02 4X4	0214-0405	0214-0405
PRAIRIE 360 09-12 4X4	0214-0507	0214-0507
PRAIRIE 360 06-08 4X4	0214-0150	0214-0150
PRAIRIE 360 03-05 4X4	0214-0271	0214-0271
PRAIRIE 400 97-02 4X4	0214-0106	0214-0106
PRAIRIE 650 02-03 4X4	0214-0271	0214-0271
PRAIRIE 700 04-06 4X4	0214-0150	0214-0150
BRUTE FORCE 650I 06-12 4X4	0214-0191	0214-0191
BRUTE FORCE 750I 08-11 4X4	0214-0606	0214-0606
BRUTE FORCE 750I 12 4X4	0214-0191	0214-0191
BRUTE FORCE 750I 05-07 4X4	0214-0191	0214-0191
TERYX 750 09-12 4X4-FROM SERIAL # 9B500713	0214-0607	0214-0607
BAYOU 300 89-04 4X4	0214-0270	0214-0270
BAYOU 400 93-99 4X4	0214-0270	0214-0270
BRUTE FORCE 650 10-12 4X4	0214-0507	0214-0507
BRUTE FORCE 650 05-09 4X4	0214-0150	0214-0150
MULE 2510 00-02 4WD-620CC & 950CC DIESEL	0214-0345	0214-0345
MULE 2510 93-99 4WD-620CC	0214-0406	0214-0406
MULE 3010 01-08 4WD-620CC & 950CC DIESEL	0214-0345	0214-0345
MULE 4010 09-12 4WD-620CC & 950CC DIESEL	0214-0508	0214-0508
MULE 610 09 4WD-400CC-TO VIN #JKIAFEA1 9B547191	0214-0407	0214-0407
MULE 610 05-08 4WD-400CC	0214-0407	0214-0407
POLARIS		
HAWKEYE 300 06-07 4X4	0214-0711	0214-0711
SPORTSMAN 300 08-10 4X4	0214-0711	0214-0711
SPORTSMAN 400 05 4X4	0214-0533	0214-0533
SPORTSMAN 400 08-10 4X4-HO	0214-0711	0214-0711
SPORTSMAN 450 06 4X4	0214-0707	0214-0707
SPORTSMAN 450 07 4X4-AFTER 7/25/06	0214-0710	0214-0710
SPORTSMAN 500 05 4X4	0214-0533	0214-0533
SPORTSMAN 500 06 4X4	0214-0707	0214-0707
SPORTSMAN 500 07 4X4-AFTER 7/25/06	0214-0710	0214-0710
SPORTSMAN 500 08-10 4X4	0214-0710	0214-0710
SPORTSMAN X2 500 06-07 4X4-AFTER 7/25/06	0214-0710	0214-0710
SPORTSMAN X2 500 08-09 4X4	0214-0710	0214-0710
SPORTSMAN X2 550 10 4X4	0214-0596	0214-0596
SPORTSMAN XP 550 09-10 4X4	0214-0596	0214-0596
SPORTSMAN 600 05 4X4	0214-0533	0214-0533
SPORTSMAN 700 05 4X4	0214-0533	0214-0533
SPORTSMAN 700 06 4X4	0214-0707	0214-0707
SPORTSMAN 700 07 4X4-AFTER 7/25/06	0214-0710	0214-0710
SPORTSMAN 800 05 4X4	0214-0533	0214-0533
SPORTSMAN 800 06 4X4-OB HOUSING STAMPED *NEAPCO*	0214-0533	0214-0533
SPORTSMAN 800 06 4X4-OB HOUSING STAMPED *GKN*	0214-0707	0214-0707
SPORTSMAN 800 07 4X4-AFTER 7/25/06	0214-0710	0214-0710
SPORTSMAN 800 08 4X4	0214-0710	0214-0710
SPORTSMAN 800 09-10 4X4	0214-0710	0214-0710
SPORTSMAN 800 09-10 6X6	0214-0710	0214-0710
SPORTSMAN X2 800 07 4X4-AFTER 7/25/06	0214-0710	0214-0710
SPORTSMAN X2 800 08-09 4X4	0214-0710	0214-0710
SPORTSMAN XP850 09-10 4X4	0214-0596	0214-0596
RANGER EV-ELECTRIC VEHICLE 10	0214-0598	0214-0598
RANGER 500 06-07 4X4	0214-0352	0214-0352
RANGER 500 08 4X4	0214-0597	0214-0597
RANGER 500 09-10 4X4	0214-0712	0214-0712
RANGER XP 700 08 4X4	0214-0597	0214-0597
RANGER XP 700 06-07 4X4	0214-0352	0214-0352
RANGER XP 700 09 4X4	0214-0712	0214-0712

FITS MODEL	LEFT HAND AXLE PART #	RIGHT HAND AXLE PART #
FRONT CV HALFSHAFTS (CON'T)		
POLARIS		
RANGER 700 06-07 6X6	0214-0352	0214-0352
RANGER 700 08-09 4X4-EFI CREW	0214-0597	0214-0597
RANGER 700 08-09 6X6	0214-0597	0214-0597
RANGER 800 10 4X4	0214-0712	0214-0712
RANGER 800 10 6X6	0214-0712	0214-0712
RANGER 900 13	0214-0595	0214-0595
RZR 570 12-13	0214-0538	0214-0538
RZR 800 11-13 4-SEATER	0214-0595	0214-0595
RZR 800 11-13	0214-0538	0214-0538
RZR 800 11-13 S SERIES	0214-0595	0214-0595
SUZUKI		
EIGER 400 03-04 4X4-W/ 68LAC OB	0214-0401	0214-0403
EIGER 400 02 4X4	0214-0401	0214-0403
KING QUAD 300 99-02 4X4	0214-0275	0214-0275
KING QUAD 300 96-98 4X4-W/ 68LAC IB	0214-0275	0214-0275
KING QUAD 300 96-98 4X4-W/ 71LAC IB	0214-0402	0214-0402
KING QUAD 300 91-93 4X4	0214-0402	0214-0402
KING QUAD 700 05 4X4-AT	0214-0532	0214-0532
Q.U.V. 620 05 4X4	0214-0345	0214-0345
QUADMASTER 500 01 4X4	0214-0401	0214-0401
QUADMASTER 500 00 4X4	0214-0275	0214-0275
QUADRUNNER 250 99-02 4X4	0214-0399	0214-0399
QUADRUNNER 250 97-98 4X4-W/ 68LAC IB	0214-0275	0214-0399
QUADRUNNER 250 97-98 4X4-W/ 71LAC IB	0214-0400	0214-0400
QUADRUNNER 250 88-96 4X4	0214-0400	0214-0400
QUADRUNNER 300 94-95 4X4	0214-0402	0214-0402
QUADRUNNER 500 01-02 4X4	0214-0401	0214-0401
QUADRUNNER 500 98-00 4X4	0214-0275	0214-0275
TWIN PEAKS 700 04-05 4X4	0214-0150	0214-0150
YAMAHA		
TIMBERWOLF 250 94-00 4X4	0214-0102	0214-0102
WOLVERINE 350 01-05 4X4	0214-0149	0214-0149
WOLVERINE 350 95-00 4X4	0214-0103	0214-0103
WOLVERINE 450 SPORT 06-08 4X4	0214-0192	0214-0192
BIG BEAR 350 98-99 4X4	0214-0103	0214-0103
BIG BEAR 350 97 4X4-W/ 68AC IB	0214-0102	0214-0102
BIG BEAR 350 97 4X4-W/ 68LAC IB	0214-0103	0214-0103
BIG BEAR 350 89-96 4X4	0214-0102	0214-0102
BIG BEAR 350 87-88 4X4	0214-0387	0214-0387
BIG BEAR 400 07-08 4X4-W/ IRS	0214-0528	0214-0529
BIG BEAR 400 02-06 4X4-EXC. IRS	0214-0350	0214-0350
BIG BEAR 400 00-01 4X4-EXC. IRS	0214-0103	0214-0103
BRUIN 350 04-06 4X4	0214-0192	0214-0192
GRIZZLY 350 07-08 4X4-EXC. IRS	0214-0192	0214-0192
GRIZZLY 350 07-08 4X4-W/ IRS	0214-0528	0214-0529
GRIZZLY 400 07 4X4	0214-0192	0214-0192
GRIZZLY 450 08 4X4	0214-0528	0214-0529
GRIZZLY 450 07 4X4	0214-0194	0214-0194
GRIZZLY 600 99-01 4X4	0214-0107	0214-0107
GRIZZLY 600 98 4X4	0214-0388	0214-0388
GRIZZLY 660 04-08 4X4	0214-0153	0214-0153
GRIZZLY 660 03 4X4-W/ 68 LAC OB	0214-0153	0214-0153
GRIZZLY 660 03 4X4-W/ UJ 68 OB	0214-0104	0214-0104
GRIZZLY 660 02 4X4	0214-0154	0214-0154
GRIZZLY 700 07-08 4X4	0214-0536	0214-0536
KODIAK 400 03-06 4X4	0214-0192	0214-0192
KODIAK 400 00-02 4X4	0214-0349	0214-0349
KODIAK 400 99 4X4	0214-0103	0214-0103
KODIAK 400 93-98 4X4	0214-0102	0214-0102
KODIAK 450 03-06 4X4	0214-0194	0214-0194
RHINO 450 06-07 4X4	0214-0348	0214-0348
RHINO 660 06-07 4X4	0214-0348	0214-0348
RHINO 660 05 4X4	0214-0396	0214-0396
RHINO 660 04 4X4	0214-0391	0214-0391
RHINO 700 SE 08-09 4X4	0214-0591	0214-0591

PLOWS
WINCHES
UTV
RACKS
LUGGAGE
BODY
CONTROLS
ELECTRICAL
WHEELS & TIRES
SUSPENSION & DRIVE
ENGINE
NRA BY MOOSE
RIDER
TOWING
GARAGE
PROMO

REAR

CV HALFSHAFTS > \$177.95-\$218.95

Heavy-duty fully assembled outboard joint and boot assembly. Includes axle bar, inboard puncture resistant boot, clamps and grease. Polaris halfshafts include axle bar, inboard universal joint and yoke assembly.

Made in the USA.



FITS MODEL	LEFT HAND AXLE PART #	RIGHT HAND AXLE PART #
REAR CV HALFSHAFTS		
ARCTIC CAT		
250 02-04 2X4	0214-0353	0214-0353
250 02-04 4X4	0214-0353	0214-0353
250 01 2X4- 19 TEETH ON BAR	0214-0353	0214-0353
250 01 4X4- 19 TEETH ON BAR	0214-0353	0214-0353
300 03-04 4X4	0214-0353	0214-0353
300 02 2X4	0214-0353	0214-0353
300 02 4X4	0214-0353	0214-0353
300 01 2X4- 19 TEETH ON BAR	0214-0353	0214-0353
300 01 4X4- 19 TEETH ON BAR	0214-0353	0214-0353
400 06-08 4X4-	0214-0347	0214-0347
400 05 4X4	0214-0268	0214-0268
400 02-04 2X4	0214-0267	0214-0267
400 02-04 4X4	0214-0267	0214-0267
500 06-08 4X4	0214-0347	0214-0347
500 05 4X4	0214-0268	0214-0268
500 03-04 4X4	0214-0267	0214-0267
650 06-08 4X4- EXC. PROWLER XT	0214-0347	0214-0347
650 06-08 4X4- PROWLER XT	0214-0346	0214-0346
650 05 4X4	0214-0268	0214-0268
700 07-08 4X4	0214-0347	0214-0347
CAN-AM		
OUTLANDER 500 07 4X4	0214-0717	0214-0716
OUTLANDER 650 06-07 4X4	0214-0717	0214-0716
OUTLANDER 800 06-07 4X4	0214-0717	0214-0716
RENEGADE 800 07 4X4	0214-0717	0214-0716
HONDA		
TRX680 RINCON 06-08 4X4	0214-0160	0214-0160
TRX650 RINCON 03-05 4X4	0214-0160	0214-0160
KAWASAKI		
BRUTE FORCE 650I 09-12 4X4	0214-0505	0214-0505
BRUTE FORCE 650I 06-08 4X4	0214-0193	0214-0193
BRUTE FORCE 750I 08-12 4X4	0214-0505	0214-0505
BRUTE FORCE 750I 05-07 4X4	0214-0193	0214-0193
TERYX 750 08-12 4X4 (NOT FOR 4 MODEL)	0214-0506	0214-0506
POLARIS-MIDDLES		
RANGER 700 09 6X6	0214-0604	0214-0604
RANGER 700 08 6X6	0214-0601	0214-0601
RANGER 800 10 6X6	0214-0604	0214-0604
POLARIS		
HAWKEYE 300 06-07 2X4	0214-0404	0214-0404
HAWKEYE 300 06-07 4X4	0214-0404	0214-0404
HAWKEYE 300 08-10 2X4	0214-0404	0214-0404
SPORTSMAN 300 08-10 4X4	0214-0404	0214-0404
SPORTSMAN 335 00 4X4-SOME APPLICATIONS USE U-JOINTS	0214-0272	0214-0272
SPORTSMAN 400 01-02 4X4	0214-0272	0214-0272
SPORTSMAN 400 03-05 4X4	0214-0273	0214-0273
SPORTSMAN 400 08-10 4X4-HO	0214-0404	0214-0404
SPORTSMAN 450 06-07 4X4	0214-0708	0214-0708
SPORTSMAN 500 08-10 4X4-EXC. TOURING	0214-0599	0214-0599
SPORTSMAN 500 08-10 4X4-TOURING	0214-0600	0214-0600
SPORTSMAN 500 99-02 4X4	0214-0272	0214-0272
SPORTSMAN 500 03-05 4X4	0214-0273	0214-0273
SPORTSMAN 500 06-07 4X4	0214-0708	0214-0708
SPORTSMAN X2 500 06-07 4X4	0214-0709	0214-0709
SPORTSMAN X2 500 08-09 4X4	0214-0600	0214-0600
SPORTSMAN X2 550 10 4X4	0214-0605	0214-0605
SPORTSMAN XP 550 10 4X4-EPS	0214-0605	0214-0605
SPORTSMAN XP550 10 4X4-EXC. EPS	0214-0602	0214-0602
SPORTSMAN XP550 09 4X4	0214-0603	0214-0603
SPORTSMAN 600 03-05 4X4	0214-0273	0214-0273
SPORTSMAN 700 02 4X4	0214-0594	0214-0594
SPORTSMAN 700 03-05 4X4	0214-0273	0214-0273
SPORTSMAN 700 06-07 4X4	0214-0708	0214-0708
SPORTSMAN 800 05 4X4	0214-0273	0214-0273
SPORTSMAN 800 08 4X4 EXC.TOURING	0214-0599	0214-0599
SPORTSMAN 800 08 4X4-TOURING	0214-0600	0214-0600
SPORTSMAN 800 09 4X4-EXC.TOURING	0214-0599	0214-0599
SPORTSMAN 800 09 4X4-TOURING	0214-0600	0214-0600

FITS MODEL	LEFT HAND AXLE PART #	RIGHT HAND AXLE PART #
REAR CV HALFSHAFTS		
POLARIS (CONT)		
SPORTSMAN 800 09 6X6	0214-0599	0214-0599
SPORTSMAN 800 10 4X4	0214-0599	0214-0599
SPORTSMAN 800 10 6X6	0214-0599	0214-0599
SPORTSMAN X2 800 08-09 4X4	0214-0600	0214-0600
SPORTSMAN XP850 10 4X4-EPS	0214-0605	0214-0605
SPORTSMAN XP850 10 4X4-EXC. EPS	0214-0602	0214-0602
SPORTSMAN XP850 09 4X4	0214-0603	0214-0603
SPORTSMAN 800 06-07 4X4	0214-0708	0214-0708
SPORTSMAN X2 800 07 4X4	0214-0709	0214-0709
RANGER 500 08 2X4	0214-0601	0214-0601
RANGER 500 08 4X4	0214-0601	0214-0601
RANGER 500 09 2X4	0214-0604	0214-0604
RANGER 500 09 4X4	0214-0604	0214-0604
RANGER 500 10 4X4	0214-0714	0214-0714
RANGER 700 08 4X4-EFI CREW	0214-0601	0214-0601
RANGER 700 09 4X4-EFI CREW	0214-0604	0214-0604
RANGER XP 700 09 4X4	0214-0604	0214-0604
RANGER XP 700 08 4X4	0214-0601	0214-0601
RANGER 800 10 6X6	0214-0604	0214-0604
RANGER 800 10 4X4	0214-0714	0214-0714
RZR 08-10 4X4	0214-0539	0214-0539
RZR S "SPORT" 09-10 4X4	0214-0713	0214-0713
SUZUKI		
KING QUAD 700 05 4X4-AT	0214-0274	0214-0274
YAMAHA		
GRIZZLY 350 07-08 4X4-W/ IRS	0214-0351	0214-0351
GRIZZLY 400 07 4X4	0214-0351	0214-0351
GRIZZLY 450 08 4X4	0214-0351	0214-0351
GRIZZLY 450 07 4X4	0214-0351	0214-0351
GRIZZLY 660 06-08 4X4	0214-0389	-
GRIZZLY 660 03-05 4X4	0214-0156	0214-0157
GRIZZLY 660 02 4X4	0214-0277	0214-0276
GRIZZLY 700 07-08 4X4	0214-0537	0214-0537
KODIAK 400 05-06 4X4	0214-0351	0214-0351
KODIAK 450 05-06 4X4	0214-0351	0214-0351
RHINO 450 06 4X4	0214-0393	0214-0394
RHINO 660 06-07 4X4	0214-0393	0214-0394
RHINO 660 05 4X4	0214-0395	0214-0527
RHINO 660 04 4X4	0214-0390	0214-0392
RHINO 700 SE 08-09 4X4	0214-0393	0214-0526

COMPLETE FRONT

AXLE ASSEMBLIES > \$231.95-\$394.95

Fully assembled outboard CV Joint. Heavy-duty puncture resistant boot and axle bar. Some models come with a universal joint & yoke assembly or a fully assembled inboard CV joint. Made in the USA.



FITS MODEL	LEFT AXLE PART #	RIGHT AXLE PART #
COMPLETE FRONT AXLE ASSEMBLIES		
ARCTIC CAT		
300 02-04 4X4	-	0214-0697
375 02 4X4	0214-0697	0214-0697
400 02-04 4X4-W/ FIS	0214-0617	0214-0617
400 02-04 4X4-EXC. FIS MACHINES WITH FULLY INDEPENDENT SUSPENSION	0214-0697	0214-0697
400 06 4X4-FIS-MACHINES WITH FULLY INDEPENDENT SUSPENSION	0214-0702	0214-0701
400 06 4X4-TBX	0214-0701	0214-0701
400 06 4X4-TRV	0214-0701	0214-0701
400 07-08 4X4-FIS-MACHINES WITH FULLY-INDEPENDENT SUSPENSION	0214-0702	0214-0701
400 07-08 4X4- TRV	0214-0701	0214-0701
500 02 4X4-W/ FIS	0214-0617	0214-0617
500 02 4X4-TBX	0214-0697	0214-0697
500 03-04 4X4	0214-0617	0214-0617
500 06 4X4-FIS-MACHINES WITH FULLY INDEPENDENT SUSPENSION	0214-0702	0214-0701
500 06 4X4-TBX	0214-0702	0214-0701
500 06 4X4-TRV	0214-0701	0214-0701
500 07-08 4X4	0214-0702	0214-0701
650 04 4X4	-	0214-0617
650 06-08 4X4-EXC. PROWLER XT	0214-0702	0214-0701
700 07-08 4X4	0214-0702	0214-0701

CONTINUED ON NEXT PAGE

FITS MODEL	LEFT AXLE PART #	RIGHT AXLE PART #
COMPLETE FRONT AXLE ASSEMBLIES (CON'T)		
HONDA		
TRX350 RANCHER 06 4X4	0214-0680	0214-0680
TRX450 FOREMAN 98-04 4X4	0214-0678	0214-0679
TRX500 FOREMAN 05-06 4X4	0214-0681	0214-0682
TRX500 FOREMAN 07 4X4-EXC. ES W/ POWER STEERING	0214-0681	0214-0682
TRX500 FOREMAN 07 4X4-ES W/ POWER STEERING	0214-0683	0214-0684
TRX500 FOREMAN 08-09 4X4	0214-0683	0214-0684
TRX500 RUBICON 01-04 4X4	0214-0611	0214-0612
TRX500 RUBICON 05-07 4X4	0214-0681	0214-0682
TRX500 RUBICON 08-09 4X4	0214-0683	0214-0684
TRX650 RINCON 05 4X4	0214-0681	0214-0682
TRX680 RINCON 06-07 4X4	0214-0681	0214-0682
TRX680 RINCON 08-09 4X4	0214-0683	0214-0684
KAWASAKI		
PRAIRIE 360 06-08 4X4	0214-0703	-
PRAIRIE 360 09-12 4X4	0214-0524	0214-0525
BRUTE FORCE 650 05-09 4X4	0214-0703	-
BRUTE FORCE 650 10-12 4X4	0214-0524	0214-0525
BRUTE FORCE 650I 06-12 4X4	0214-0522	0214-0523
PRAIRIE 700 04-06 4X4	0214-0703	-
BRUTE FORCE 750I 05-07 4X4	0214-0522	0214-0523
BRUTE FORCE 750I 08-11 4X4	-	0214-0704
BRUTE FORCE 750I 12 4X4	0214-0522	0214-0523
MULE 610 05-12 4WD- 400CC	0214-0521	0214-0521
MULE 2510 00-02 4WD-620CC & 950CC DIESEL	0214-0519	0214-0519
MULE 3010 01-08 4WD-620CC & 950CC DIESEL	0214-0519	0214-0519
MULE 4010 09-12 4WD-620CC & 950CC DIESEL	0214-0519	0214-0519
TERYX 750 08-12 4X4	0214-0618	0214-0618
POLARIS		
250 93 4X4	0214-0338 ¹	0214-0338 ¹
250 93 6X6	0214-0338 ¹	0214-0338 ¹
TRAIL BOSS 250 91 4X4	0214-0338 ¹	0214-0338 ¹
TRAIL BOSS 250 92 4X4-W/ USA OB	0214-0338 ¹	0214-0338 ¹
BIG BOSS 250 91 6X6	0214-0338 ¹	0214-0338 ¹
BIG BOSS 250 92 6X6-W/ USA OB	0214-0338 ¹	0214-0338 ¹
XPLORER 250 00-02 4X4	0214-0279 ¹	0214-0279 ¹
300 94 4X4	0214-0338 ¹	0214-0338 ¹
300 94 6X6	0214-0338 ¹	0214-0338 ¹
HAWKEYE 300 06-07 4X4	0214-0689	0214-0689
SPORTSMAN 300 08-10 4X4	0214-0689	0214-0689
XPLORER 300 97 4X4-FROM 1/1/97	0214-0101 ¹	0214-0101 ¹
XPLORER 300 98-99 4X4	0214-0101 ¹	0214-0101 ¹
MAGNUM 325 00 4X4	0214-0101 ¹	0214-0101 ¹
MAGNUM 325 01-02 4X4-EXC.HDS (VISCO-LOK)	0214-0101 ¹	0214-0101 ¹
XPEDITION 325 00-02 4X4	0214-0101 ¹	0214-0101 ¹
ATP 330 04 4X4	0214-0278 ¹	0214-0278 ¹
MAGNUM 330 03 4X4-EXC. HDS (VISCO-LOK)	0214-0278 ¹	0214-0278 ¹
MAGNUM 330 04 4X4-EXC.HDS (VISCO-LOK)	0214-0278 ¹	0214-0278 ¹
SPORTSMAN 335 99-00 4X4	0214-0101 ¹	0214-0101 ¹
350L 90 4X4	0214-0338 ¹	0214-0338 ¹
350L 93 4X4	0214-0338 ¹	0214-0338 ¹
350L 93 6X6	0214-0338 ¹	0214-0338 ¹
TRAIL BOSS 350L 90-91 4X4	0214-0338 ¹	0214-0338 ¹
TRAIL BOSS 350L 92 4X4-W/ USA OB	0214-0338 ¹	0214-0338 ¹
SCRAMBLER 400 00-02 4X4	0214-0279 ¹	0214-0279 ¹
SCRAMBLER 400 95-96 4X4-W/ USA OB	0214-0384 ¹	0214-0384 ¹
SCRAMBLER 400 98 4X4	0214-0101 ¹	0214-0101 ¹
SCRAMBLER 400 99 4X4-W/ BTB OB	0214-0101 ¹	0214-0101 ¹
SCRAMBLER 400 99 4X4-W/ USA OB	0214-0279 ¹	0214-0279 ¹
SPORTSMAN 400 01 4X4	0214-0101 ¹	0214-0101 ¹
SPORTSMAN 400 02-03 4X4	0214-0279 ¹	0214-0279 ¹
SPORTSMAN 400 04 4X4-W/ FEMALE SPLINE ON IB YOKE	0214-0279 ¹	0214-0279 ¹
SPORTSMAN 400 04 4X4-W/ MALE SPLINE ON IB YOKE	0214-0278 ¹	0214-0278 ¹
SPORTSMAN 400 05 4X4	0214-0386	0214-0386
SPORTSMAN 400 08-10 4X4	0214-0689	0214-0689
SPORTSMAN 400 95-96 4X4-W/ USA OB	0214-0384 ¹	0214-0384 ¹
SPORTSMAN 400 97 4X4	0214-0101 ¹	0214-0101 ¹
400L 94 6X6	0214-0338 ¹	0214-0338 ¹
BIG BOSS 400L 97 6X6-FROM 1/1/97	0214-0101 ¹	0214-0101 ¹
XPLORER 400 95-96 4X4-W/ USA OB	0214-0384 ¹	0214-0384 ¹
XPLORER 400 97 4X4-FROM 1/1/97	0214-0101 ¹	0214-0101 ¹
XPLORER 400 98 4X4	0214-0101 ¹	0214-0101 ¹
XPLORER 400 99-02 4X4	0214-0279 ¹	0214-0279 ¹
MAGNUM 425 95-96 4X4-W/ USA OB	0214-0384 ¹	0214-0384 ¹
MAGNUM 425 95-96 6X6-W/ USA OB	0214-0384 ¹	0214-0384 ¹
MAGNUM 425 97 4X4-FROM 1/1/97	0214-0101 ¹	0214-0101 ¹

FITS MODEL	LEFT AXLE PART #	RIGHT AXLE PART #
COMPLETE FRONT AXLE ASSEMBLIES (CON'T)		
POLARIS (CON'T)		
MAGNUM 425 97 6X6-FROM 1/1/97	0214-0101 ¹	0214-0101 ¹
MAGNUM 425 98 4X4	0214-0101 ¹	0214-0101 ¹
XPEDITION 425 00-01 4X4	0214-0101 ¹	0214-0101 ¹
XPEDITION 425 02 4X4	0214-0279 ¹	0214-0279 ¹
SPORTSMAN 450 06 4X4	0214-0386	0214-0386
SPORTSMAN 450 07 4X4-AFTER 7/25/06	0214-0616	0214-0616
ATP 500 H.O. 04 4X4	0214-0278 ¹	0214-0278 ¹
BIG BOSS 500 98-99 6X6	0214-0101 ¹	0214-0101 ¹
MAGNUM 500 01 4X4-EXC. HDS (VISCO-LOK)	0214-0101 ¹	0214-0101 ¹
MAGNUM 500 02 2X4-HDS (VISCO-LOK)	0214-0279 ¹	0214-0279 ¹
MAGNUM 500 02 4X4-EXC. HDS (VISCO-LOK)	0214-0383 ¹	0214-0383 ¹
MAGNUM 500 99-00 4X4	0214-0101 ¹	0214-0101 ¹
SCRAMBLER 500 97 4X4-FROM 1/1/97	0214-0101 ¹	0214-0101 ¹
SCRAMBLER 500 98 4X4	0214-0101 ¹	0214-0101 ¹
SCRAMBLER 500 99-09 4X4	0214-0279 ¹	0214-0279 ¹
SPORTSMAN 500 00-01 4X4	0214-0101 ¹	0214-0101 ¹
SPORTSMAN 500 00-01 6X6	0214-0101 ¹	0214-0101 ¹
SPORTSMAN 500 02-03 4X4	0214-0279 ¹	0214-0279 ¹
SPORTSMAN 500 02-03 6X6	0214-0279 ¹	0214-0279 ¹
SPORTSMAN 500 04 4X4-W/ FEMALE SPLINE ON IB YOKE	0214-0278 ¹	0214-0278 ¹
SPORTSMAN 500 04 4X4-W/ MALE SPLINE ON IB YOKE	0214-0278 ¹	0214-0278 ¹
SPORTSMAN 500 04 6X6	0214-0279 ¹	0214-0279 ¹
SPORTSMAN 500 05-06 4X4	0214-0386	0214-0386
SPORTSMAN 500 05-06 6X6	0214-0279 ¹	0214-0386
SPORTSMAN 500 07 4X4-AFTER 7/25/06	0214-0616	0214-0616
SPORTSMAN 500 07 6X6	0214-0279 ¹	0214-0279 ¹
SPORTSMAN 500 96 4X4-W/ USA OB	0214-0384 ¹	0214-0384 ¹
SPORTSMAN 500 97 4X4	0214-0279 ¹	0214-0279 ¹
SPORTSMAN 500 98-99 4X4	0214-0101 ¹	0214-0101 ¹
SPORTSMAN X2 500 07 4X4-AFTER 7/25/06	0214-0616	0214-0616
SPORTSMAN X2 500 08-09 4X4	0214-0616	0214-0616
SPORTSMAN X2 550 10 4X4	0214-0690	0214-0690
SPORTSMAN 600 03-04 4X4	0214-0278 ¹	0214-0278 ¹
SPORTSMAN 600 05 4X4	0214-0386	0214-0386
SPORTSMAN 700 02 4X4-FROM 5/1/02	0214-0278 ¹	0214-0278 ¹
SPORTSMAN 700 02 4X4-TO 5/1/02	0214-0383 ¹	0214-0383 ¹
SPORTSMAN 700 03-04 4X4	0214-0278 ¹	0214-0278 ¹
SPORTSMAN 700 05-06 4X4	0214-0386	0214-0386
SPORTSMAN 700 07 4X4-AFTER 7/25/06	0214-0616	0214-0616
SPORTSMAN 800 05-06 4X4	0214-0386	0214-0386
SPORTSMAN 800 07 4X4-AFTER 7/25/06	0214-0616	0214-0616
SPORTSMAN 800 08-10 4X4	0214-0616	0214-0616
SPORTSMAN 850 10 4X4	0214-0690	0214-0690
SPORTSMAN X2 800 07 4X4-AFTER 7/25/06	0214-0616	0214-0616
SPORTSMAN X2 800 08-09 4X4	0214-0616	0214-0616
SPORTSMAN XP 550 09-10 4X4	0214-0690	0214-0690
SPORTSMAN XP 850 09-10 4X4	0214-0690	0214-0690
XPLORER 500 97 4X4	0214-0279 ¹	0214-0279 ¹
RANGER 02 4X4-SERIES 10	0214-0336 ¹	0214-0336 ¹
RANGER 02 6X6-SERIES 10	0214-0336 ¹	0214-0336 ¹
RANGER 03-04 4X4-SERIES 11	0214-0336 ¹	0214-0336 ¹
RANGER 03-04 6X6-SERIES 11	0214-0336 ¹	0214-0336 ¹
RANGER 400 10-13 4X4	0214-0693	0214-0693
RANGER 500 04-05 4X4	0214-0516	0214-0516
RANGER 500 04-05 6X6	0214-0336 ¹	0214-0336 ¹
RANGER 500 06-07 4X4	0214-0516	0214-0516
RANGER 500 08-08 4X4	0214-0614	-
RANGER 500 09-10 4X4	0214-0691	0214-0691
RANGER 500 11-13 4X4	0214-0693	0214-0693
RANGER 700 06-07 6X6	0214-0516	0214-0516
RANGER 700 08-09 4X4	0214-0614	0214-0614
RANGER 700 08-09 6X6	0214-0614	0214-0614
RANGER 800 10 4X4	0214-0691	0214-0691
RANGER 800 10 6X6	0214-0691	0214-0691
RANGER 99-01 6X6-SERIES 99	0214-0385 ¹	0214-0385 ¹
RANGER XP 700 06-07 4X4	0214-0516	0214-0516
RANGER XP 700 08 4X4	0214-0614	0214-0614
RANGER XP 700 09 4X4	0214-0691	0214-0691
RANGER 900 XP 13	0214-0692	0214-0692
RZR 570 12-13	0214-0517	0214-0517
RZR 800 11-13 4 SEATER	0214-0692	0214-0692
RZR 800 11-13 S	0214-0517	0214-0517
RZR 800 11-13	0214-0692	0214-0692
RZR 800 08-10 4X4	0214-0517	0214-0517

CONTINUED ON NEXT PAGE

PLOWS
WINCHES
UTV
RACKS
LUGGAGE
BODY
CONTROLS
ELECTRICAL
WHEELS & TIRES
SUSPENSION & DRIVE
ENGINE
NRA BY MODEL
RIDER
TOWING
GARAGE
PROMO

FITS MODEL	LEFT AXLE PART #	RIGHT AXLE PART #
COMPLETE FRONT AXLE ASSEMBLIES (CON'T)		
POLARIS (CON'T)		
RZR 800 S "SPORT" 09-10 4X4	0214-0692	0214-0692
YAMAHA		
TIMBERWOLF 250 94-00 4X4	0214-0510	0214-0510
WOLVERINE 350 95-00 4X4	0214-0511	0214-0511
BIG BEAR 350 98-99 4X4	0214-0511	0214-0511
BIG BEAR 350 97 4X4-W/ 68AC IB INBOARD CV JOINT HAS NUMBERS STAMPED INTO THE BELL TO HELP IDENTIFY	0214-0510	0214-0510
BIG BEAR 350 97 4X4-W/ 68LAC IB INBOARD CV JOINT HAS NUMBERS STAMPED INTO THE BELL TO HELP IDENTIFY	0214-0511	0214-0511
BIG BEAR 350 89-96 4X4	0214-0510	0214-0510
TIMBER 350 04-06 4X4	0214-0512	0214-0512
GRIZZLY 350 07-08 4X4-EXC. IRS	0214-0512	0214-0512
KODIAK 400 03-06 4X4	0214-0512	0214-0512
KODIAK 400 99 4X4	0214-0511	0214-0511
KODIAK 400 93-98 4X4	0214-0510	0214-0510
BIG BEAR 400 00-01 4X4-EXC. IRS	0214-0511	0214-0511
BIG BEAR 400 02-06 4X4-EXC. IRS	0214-0677	0214-0677
GRIZZLY 400 07 4X4	0214-0512	0214-0512
WOLVERINE 450 SPORT 06-08 4X4	0214-0512	0214-0512
GRIZZLY 600 99-01 4X4	0214-0609	0214-0609
GRIZZLY 660 03-08 4X4	0214-0339	0214-0282
GRIZZLY 700 07-08 4X4	0214-0513	0214-0513
RHINO 450 06-07 4X4	0214-0341	0214-0342
RHINO 660 05 4X4	0214-0675	0214-0676
RHINO 660 06-07 4X4	0214-0341	0214-0342
RHINO 660 04 4X4	0214-0281	-
RHINO 700 SE 08-09 4X4	0214-0610	0214-0610
* INCLUDES INNER U-JOINT		



COMPLETE REAR AXLE ASSEMBLIES > \$247.95-\$394.95

Fully assembled outboard CV joint. Heavy-duty puncture resistant boot and axle bar. Some models come with a universal joint & yoke assembly or a fully assembled inboard CV joint. Made in the USA.

FITS MODEL	LEFT AXLE PART #	RIGHT AXLE PART #
COMPLETE REAR AXLE ASSEMBLIES		
ARCTIC CAT		
400 02-04 2X4 & 4X4	0214-0617	0214-0617
400 05 4X4	0214-0698	0214-0698
400 06-08 4X4	0214-0700	0214-0700
500 03-04 4X4	0214-0617	0214-0617
500 05 4X4	0214-0698	0214-0698
500 06-08 4X4	0214-0700	0214-0700
650 04-05 4X4	0214-0698	0214-0698
650 06-08 4X4-PROWLER XT	0214-0699	0214-0699
650 06-08 4X4-EXC. PROWLER XT	0214-0700	0214-0700
700 07-08 4X4	0214-0700	0214-0700
KAWASAKI		
BRUTE FORCE 650I 06-12 4X4	0214-0520	0214-0520
BRUTE FORCE 750I 05-12 4X4	0214-0520	0214-0520
TERYX 750 08-09 4X4	0214-0705	0214-0706
POLARIS		
HAWKEYE 300 08-10 2X4	0214-0613	0214-0613
HAWKEYE 300 06-07 2X4	0214-0613	0214-0613
HAWKEYE 300 06-07 4X4	0214-0613	0214-0613
SPORTSMAN 300 08-10 4X4	0214-0613	0214-0613
SPORTSMAN 335 00 4X4	0214-0283	0214-0283
SPORTSMAN 400 08-10 4X4	0214-0613	0214-0613
SPORTSMAN 400 03-05 4X4	0214-0286	0214-0286
SPORTSMAN 400 01-02 4X4	0214-0283	0214-0283
SPORTSMAN 450 06-07 4X4	0214-0286	0214-0286
SPORTSMAN 500 03-07 4X4	0214-0286	0214-0286
SPORTSMAN 500 99-02 4X4	0214-0283	0214-0283
SPORTSMAN X2 500 06-07 4X4	0214-0688	0214-0688
SPORTSMAN X2 500 08-09 4X4	0214-0622	0214-0622
SPORTSMAN X2 550 10 4X4	0214-0615	0214-0615
SPORTSMAN XP 550 09 4X4	0214-0623	0214-0623
SPORTSMAN XP 550 10 4X4	0214-0615	0214-0615
SPORTSMAN XP 550 10 4X4-EXC. EPS	0214-0629	0214-0629
SPORTSMAN 600 03-05 4X4	0214-0286	0214-0286
SPORTSMAN 700 02 4X4	0214-0685	0214-0685

FITS MODEL	LEFT AXLE PART #	RIGHT AXLE PART #
COMPLETE REAR AXLE ASSEMBLIES (CON'T)		
POLARIS (CON'T)		
SPORTSMAN 700 03-07 4X4	0214-0286	0214-0286
SPORTSMAN 800 05-07 4X4	0214-0286	0214-0286
SPORTSMAN 800 08 4X4-EXC. TOURING	0214-0626	0214-0626
SPORTSMAN 800 08 4X4-TOURING	0214-0622	0214-0622
SPORTSMAN 800 09 4X4-EXC. TOURING	0214-0626	0214-0626
SPORTSMAN 800 09 4X4-TOURING	0214-0622	0214-0622
SPORTSMAN 800 09 6X6	0214-0626	0214-0626
SPORTSMAN 800 10 4X4	0214-0626	0214-0626
SPORTSMAN 800 10 6X6	0214-0626	0214-0626
SPORTSMAN X2 800 07 4X4	0214-0688	0214-0688
SPORTSMAN X2 800 08-09 4X4	0214-0622	0214-0622
SPORTSMAN 850 10 4X4	0214-0615	0214-0615
SPORTSMAN XP 850 09 4X4	0214-0623	0214-0623
SPORTSMAN XP 850 10 4X4	0214-0629	0214-0629
RANGER 500 05-07 2X4	0214-0686	0214-0687
RANGER 500 05-07 4X4	0214-0686	0214-0687
RANGER 500 08 2X4	0214-0695	0214-0696
RANGER 500 08 4X4	0214-0695	0214-0696
RANGER 500 09 2X4	0214-0694	0214-0628
RANGER 500 09 4X4	0214-0694	0214-0628
RANGER 500 10 4X4	0214-0630	-
RANGER 700 08 4X4	0214-0695	0214-0696
RANGER 700 09 4X4	0214-0694	0214-0628
RANGER 700 09 6X6	0214-0627	0214-0627
RANGER XP 700 05-07 4X4	0214-0686	0214-0687
RANGER XP 700 08 4X4	0214-0695	0214-0696
RANGER XP 700 09 4X4	0214-0694	0214-0628
RANGER 700 MILITARY SPECS 08 / AFTER 1/10/08	-	0214-0625
RANGER 800 10 6X6	0214-0627	0214-0627
RANGER 800 10 6X6	0214-0694	0214-0628
RANGER 800 10 4X4	0214-0630	0214-0630
RZR S "SPORT" 09-10 4X4	0214-0624	0214-0624
RZR 08-10 4X4	0214-0518	0214-0518
YAMAHA		
GRIZZLY 350 07-08 4X4	0214-0509	0214-0509
GRIZZLY 400 07 4X4	0214-0509	0214-0509
GRIZZLY 450 07-08 4X4	0214-0509	0214-0509
GRIZZLY 660 06-08 4X4	0214-0340	-
GRIZZLY 660 03-05 4X4	0214-0280	0214-0285
GRIZZLY 660 02 4X4	0214-0379	0214-0380
GRIZZLY 700 07-08 4X4	0214-0514	0214-0514
KODIAK 400 05-06 4X4	0214-0509	0214-0509
KODIAK 450 05-06 4X4	0214-0509	0214-0509
RHINO 450 06 4X4	0214-0343	0214-0344
RHINO 660 06-07 4X4	0214-0343	0214-0344
RHINO 660 05 4X4	0214-0381	0214-0382
RHINO 660 04 4X4	0214-0284	0214-0337
RHINO 700 SE 08-09 4X4	0214-0343	0214-0515





HEAVY DUTY AXLES W/ VOODOO AXLE TECHNOLOGY >\$495.95

If you're ATV or UTV has a lift kit or extended A-arms, and requires long travel suspension, you need Moose Heavy Duty Axles-With Voodoo Axle Technology. Our revolutionary design provides ultra-high strength and the ability to operate at angles other can't. To accommodate suspension travel the axles utilize a slip spline that allows the axle to compress and extend 2". This helps to prevent disengagement of the inner CV joint from the transaxle when the suspension is at full droop. Telescoping axle bars are carried on linear motion ball bearings for smooth action that won't bind under load. Typical axles use inboard CV joints that must both operate at an angle and allow suspension travel. This dual purpose design limits articulation angle to about 25°, while travel is limited to 1.25"-1.5", which is inadequate for ATV's and UTV's with lift kits, or long travel suspension. These axles utilize fixed Rzeppa inner CV joints that allow 45° of articulation, while a slip spline in the axle shaft provides 2" of travel. Made in the USA.

FITS MODEL	LEFT HAND AXLE PART #	RIGHT HAND AXLE PART #
FRONT HEAVY DUTY AXLES		
ARCTIC CAT		
PROWLER 650 06-08 4X4-PROWLER XT	0214-0762	0214-0763
CAN-AM		
COMMANDER 800R 13 4X4	0214-0770	0214-0769
COMMANDER 1000R 13 4X4	0214-0770	0214-0769
KAWASAKI		
BRUTE FORCE 650 I 06-13	0214-0743	0214-0744
BRUTE FORCE 750 I 05-13	0214-0743	0214-0744
TERYX 750 12 4X4-EXC. TERYX4	0214-0767	0214-0767
TERYX 750 08-11 4X4	0214-0767	0214-0767
POLARIS		
RANGER 800 11-13 4X4	0214-0761	0214-0761
RANGER 800 11-13 6X6	0214-0761	0214-0761
RANGER 900 13 4X4-XP	0214-0755	0214-0755
RZR 800 08-13 (NOT FOR S & 4 MODEL)		
RZR 800 09-13 4X4-S SERIES	0214-0755	0214-0755
RZR 800 11-13 4X4-4 SEATER	0214-0755	0214-0755
RZR 900 11-13 4X4	0214-0758	0214-0758
YAMAHA		
GRIZZLY 550 09-11	0214-0738	0214-0738
GRIZZLY 660 03-08 4X4	0214-0747	0214-0748
GRIZZLY 700 07-10	0214-0738	0214-0738
RHINO 450 06-07 4X4	0214-0751	0214-0752
RHINO 660 06-07 4X4	0214-0751	0214-0752

FITS MODEL	LEFT HAND AXLE PART #	RIGHT HAND AXLE PART #
REAR HEAVY DUTY AXLES		
ARCTIC CAT		
PROWLER 650 06-08 4X4-PROWLER XT	0214-0764	0214-0764
CAN-AM		
COMMANDER 800R 13 4X4	0214-0768	0214-0768
COMMANDER 1000R 13 4X4	0214-0768	0214-0768
KAWASAKI		
BRUTE FORCE 650 I 06-13	0214-0742	0214-0742
BRUTE FORCE 750 I 05-13	0214-0742	0214-0742
TERYX 750 12 4X4-EXC. TERYX4	0214-0765	0214-0766
TERYX 750 08-11 4X4	0214-0765	0214-0766
POLARIS		
RANGER 800 11-13 4X4	0214-0757	0214-0757
RZR 570 12-13 4X4	0214-0760	0214-0760
RZR800 08-13 (NOT FOR S & 4 MODEL)	0214-0741	0214-0741
RZR 800 09-10 4X4-S SERIES	0214-0756	0214-0756
RZR 900 12-13 4X4	0214-0759	0214-0759
YAMAHA		
GRIZZLY 550 09-11	0214-0739	0214-0739
GRIZZLY 660 03-05 4X4	0214-0749	0214-0750
GRIZZLY 700 07-10	0214-0739	0214-0739
RHINO 450 06 4X4	0214-0753	0214-0754
RHINO 660 06-07 4X4	0214-0753	0214-0754

CV REBUILD KITS (INBOARD & OUTBOARD) >\$73.95-\$120.95

Improve OEM quality. Includes heavy-duty puncture-resistant boot, cage, race and balls, clamps and grease. Step-by-step instructions included. Imported.



FITS MODEL	OUTBOARD PART #	INBOARD PART #
CV REBUILD KITS		
ARCTIC CAT		
250 (FRONT AXLES) 01 4X4-18 TEETH ON BAR	-	0213-0325
250 (FRONT AXLES) 01 4X4-19 TEETH ON BAR	0213-0186	0213-0187
250 (FRONT AXLES) 02-05 4X4	0213-0186	0213-0187
250 (REAR AXLES) 99-00 2X4	-	0213-0325
250 (REAR AXLES) 01 ALL-18 TEETH ON BAR	-	0213-0325
250 (REAR AXLES) 01 ALL-19 TEETH ON BAR	0213-0186	0213-0187
250 (REAR AXLES) 02-05 ALL	0213-0186	0213-0187
300 (FRONT AXLES) 98-00 4X4	-	0213-0325
300 (FRONT AXLES) 01 4X4-18 TEETH ON BAR	-	0213-0325
300 (FRONT AXLES) 01 4X4-19 TEETH ON BAR	0213-0186	0213-0187
300 (FRONT AXLES) 02-05 4X4	0213-0186	0213-0187
300 (REAR AXLES) 98-00 ALL	-	0213-0325
300 (REAR AXLES) 01 ALL-18 TEETH ON BAR	-	0213-0325
300 (REAR AXLES) 01 ALL-19 TEETH ON BAR	0213-0186	0213-0187
300 (REAR AXLES) 02-05 ALL	0213-0186	0213-0187
400 (FRONT AXLES) 98-00 4X4	-	0213-0325
400 (FRONT AXLES) 01 4X4-18 TEETH ON BAR	-	0213-0325
400 (FRONT AXLES) 01 4X4-19 TEETH ON BAR	0213-0186	0213-0187
400 (FRONT AXLES) 02-08 4X4	0213-0186	0213-0187
400 (REAR AXLES) 02-08 ALL	0213-0186	0213-0187
454 98 4X4-FROM #13001 (FRONT AXLES)	-	0213-0325
500 (FRONT AXLES) 98-00 4X4	-	0213-0325
500 (FRONT AXLES) 01 4X4-18 TEETH ON BAR	-	0213-0325
500 (FRONT AXLES) 01 4X4-19 TEETH ON BAR	0213-0186	0213-0187
500 (FRONT AXLES) 02-08 4X4	0213-0186	0213-0187
500 (REAR AXLES) 03-08 ALL	0213-0186	0213-0187
650 (FRONT AXLES) 04-08 4X4	0213-0186	0213-0187
650 (REAR AXLES) 04-08 4X4	0213-0186	0213-0187
700 (FRONT AXLES) 07-08 4X4	0213-0186	0213-0187
700 (REAR AXLES) 07-08 4X4	0213-0186	0213-0187
CAN-AM		
OUTLANDER 330 (FRONT AXLES) 04-05 4X4	0213-0188	0213-0326
OUTLANDER 330 (REAR AXLES) 04-05 ALL	-	0213-0418
OUTLANDER 400 (FRONT AXLES) 03-05 4X4	0213-0188	0213-0326
OUTLANDER 400 (FRONT AXLES) 07-08 4X4	0213-0416	0213-0420
OUTLANDER 400 (FRONT AXLES) 06 4X4	0213-0416	0213-0417
OUTLANDER 400 (REAR AXLES) 03-08 ALL	-	0213-0418
RENEGADE 500 (FRONT AXLES) 08 4X4	0213-0416	0213-0420
QUEST 500 02-04 4X4 (FRONT AXLES)	0213-0188	0213-0326
TRAXTER 95-05 4X4 (FRONT AXLES)	0213-0188	0213-0326
OUTLANDER 500 (FRONT AXLES) 07-08 4X4	0213-0416	0213-0420
OUTLANDER 500 (REAR AXLES) 07 4X4	-	0213-0419
OUTLANDER 650 (FRONT AXLES) 07-08 4X4	0213-0416	0213-0420
OUTLANDER 650 (FRONT AXLES) 06 4X4	0213-0416	0213-0417
OUTLANDER 650 (REAR AXLES) 06-07 4X4	-	0213-0419
QUEST 650 02-04 4X4 (FRONT AXLES)	0213-0188	0213-0326
OUTLANDER 800 (FRONT AXLES) 07-08 4X4	0213-0416	0213-0420
OUTLANDER 800 (FRONT AXLES) 06 4X4	0213-0416	0213-0417
OUTLANDER 800 (REAR AXLES) 06-07 4X4	-	0213-0419
RENEGADE 800 (FRONT AXLES) 07-08 4X4	0213-0416	0213-0420
RENEGADE 800 (REAR AXLES) 07 4X4	-	0213-0419
HONDA		
TRX300 FOURTRAX 88-00 4X4	0213-0327	0213-0328
TRX350 RANCHER 86-89 4X4	0213-0327	-
TRX350 RANCHER 00-05 4X4	0213-0327	0213-0189
TRX350 RANCHER 06 4X4	-	0213-0492
TRX400 FOREMAN 95-01 4X4	0213-0327	0213-0328
TRX400 FOREMAN 03 4X4	0213-0327	0213-0189
TRX420 RANCHER ES 07-08 4X4	0213-0415	0213-0492
TRX450 FOREMAN 98-04 4X4	0213-0327	0213-0189
TRX500 RUBICON 01-04 4X4	0213-0190	0213-0189
TRX500 RUBICON 05-07 4X4	0213-0190	0213-0492
TRX500 RUBICON 08 4X4	0213-0415	0213-0492
TRX500 FOREMAN 05-06 4X4	-	0213-0492
TRX500 FOREMAN 07 4X4-ES W/ POWER STEERING	0213-0415	0213-0492
TRX500 FOREMAN 07 4X4-EXC. ES W/ POWER STEERING	0213-0190	0213-0492
TRX500 FOREMAN 08 4X4	0213-0415	0213-0492

CONTINUED ON NEXT PAGE

PLOWS
WINCHES
UTV
RACKS
LUGGAGE
BODY
CONTROLS
ELECTRICAL
WHEELS & TIRES
SUSPENSION & DRIVE
ENGINE
NRA BY MOOSE
RIDER
TOWING
GARAGE
PROMO

FITS MODEL	OUTBOARD PART #	INBOARD PART #
CV REBUILD KITS (CON'T)		
HONDA (CON'T)		
TRX650 RINCON (FRONT AXLES) 03-04 4X4	0213-0190	0213-0189
TRX650 RINCON (FRONT AXLES) 05 4X4	0213-0190	0213-0492
TRX650 RINCON (REAR AXLES) 03-04 4X4	0213-0491	0213-0329
TRX680 RINCON (FRONT AXLES) 06-07 4X4	0213-0190	0213-0492
TRX680 RINCON (FRONT AXLES) 08 4X4	0213-0415	0213-0492
TRX680 RINCON (REAR AXLES) 08 4X4	0213-0491	0213-0329
KAWASAKI		
BAYOU 300 89-04 4X4	0213-0191	0213-0192
PRAIRIE 300 99-02 4X4	-	0213-0193
PRAIRIE 360 03-05 4X4	-	0213-0193
PRAIRIE 360 06 4X4	0213-0191	0213-0194
PRAIRIE 360 09-10 4X4	0213-0495	-
BAYOU 400 93-99 4X4	0213-0191	0213-0192
PRAIRIE 400 97-02 4X4	0213-0191	0213-0330
PRAIRIE 650 02-03 4X4	-	0213-0193
BRUTE FORCE 650 05-08 4X4	0213-0191	0213-0194
BRUTE FORCE 650 10-12 4WD	0213-0495	0213-0194
BRUTE FORCE 650I (FRONT AXLES) 06-08 4X4	0213-0195	0213-0194
BRUTE FORCE 650I (REAR AXLES) 06-08 4X4	0213-0196	0213-0197
BRUTE FORCE 650I (REAR AXLES) 09 4WD	0213-0493	0213-0494
PRAIRIE 700 04-06 4X4	0213-0191	0213-0194
BRUTE FORCE 750I (FRONT AXLES) 05-07 4X4	0213-0195	0213-0194
BRUTE FORCE 750I (REAR AXLES) 05-07 4X4	0213-0196	0213-0197
BRUTE FORCE 750I (FRONT AXLES) 08-12 4WD	0213-0421	-
BRUTE FORCE 750I (REAR AXLES) 08-12 4WD	0213-0493	0213-0494
MULE 610 05-07 4X4-400CC	0213-0195	0213-0330
MULE 2510 93-99 4X4-620CC	0213-0191	-
MULE 2510 00-02 4WD-620CC & 950CC DIESEL	0213-0191	0213-0192
MULE 3010 01-08 4WD-620CC & 950CC DIESEL	0213-0191	0213-0192
MULE 4010 09-10 4WD-620CC & 950CC DIESEL	0213-0495	-
TERYX 750 (REAR AXLES) 08-09 4X4	-	0213-0422
TERYX 750 (FRONT AXLES) 09 4X4-FROM SERIAL # 9B500713	0213-0493	-
POLARIS		
250 93 4X4	0213-0199	-
250 93 6X6	0213-0199	-
BIG BOSS 250 91 6X6	0213-0199	-
BIG BOSS 250 92 6X6-W/ USA OB	0213-0199	-
TRAIL BOSS 250 87 4X4-INNER RACE IN JOINT HAS EXTERNAL SNAP RING GROOVE	0213-0203	-
TRAIL BOSS 250 91 4X4	0213-0199	-
TRAIL BOSS 250 92 4X4-W/ USA OB	0213-0199	-
XPLORER 250 00-02 4X4	0213-0199	-
300 94 4X4	0213-0199	-
300 94 6X6	0213-0199	-
300 95 4X4	0213-0198	-
300 96 4X4	0213-0199	-
XPLORER 300 96-99 4X4	0213-0198	-
HAWKEYE 300 (FRONT AXLES) 06-07 4X4	0213-0497	0213-0442
HAWKEYE 300 (REAR AXLES) 06-07 4X4	0213-0497	0213-0442
HAWKEYE 300 (REAR AXLES) 06-10 2X4	0213-0497	0213-0442
SPORTSMAN 300 (FRONT & REAR AXLES) 08-10 4X4	0213-0497	0213-0442
MAGNUM 325 00 4X4	0213-0198	-
MAGNUM 325 01-02 4X4-EXC. HDS (VISCO-LOK)	0213-0198	-
MAGNUM 325 01-02 4X4-HDS (VISCO-LOK)	0213-0206	-
XPEDITION 325 00-02 4X4	0213-0198	-
ATP 330 04 4X4	0213-0199	-
ATP 330 05 4X4	0213-0204	0213-0496
MAGNUM 330 03-04 4X4-EXC. HDS (VISCO-LOK)	0213-0199	-
MAGNUM 330 03-04 4X4-HDS (VISCO-LOK)	0213-0206	-
MAGNUM 330 05-06 4X4	0213-0204	0213-0496
SPORTSMAN 335 (FRONT AXLES) 99-00 4X4	0213-0198	-
SPORTSMAN 335 (REAR AXLES) 00 4X4-SOME MODELS USE U-JOINTS	0213-0200	0213-0201
WORKER 335 99 4X4	0213-0198	-
350L 90 4X4	0213-0199	-
350L 93 4X4	0213-0199	-
350L 93 6X6	0213-0199	-
TRAIL BOSS 350L 1990 1991 4X4	0213-0199	-
TRAIL BOSS 350L 92 4X4-W/ USA OB	0213-0199	-
400L 94 4X4	0213-0199	-
400L 94 6X6	0213-0199	-
400L 95 6X6-W/ BTB OB	0213-0198	-
400L 95 6X6-W/ USA OB	0213-0199	-
BIG BOSS 400L 1997 1997 6X6	0213-0198	-
SCRAMBLER 400 95-96 4X4-W/ BTB OB	0213-0198	-
SCRAMBLER 400 95-96 4X4-W/ USA OB	0213-0199	-

FITS MODEL	OUTBOARD PART #	INBOARD PART #
CV REBUILD KITS (CON'T)		
POLARIS (CON'T)		
SCRAMBLER 400 97-98 4X4	0213-0198	-
SCRAMBLER 400 99 4X4-W/ BTB OB	0213-0198	-
SCRAMBLER 400 99 4X4-W/ USA OB	0213-0199	-
SCRAMBLER 400 00-02 4X4	0213-0199	-
SPORTSMAN 400 (FRONT AXLES) 94 4X4	0213-0199	-
SPORTSMAN 400 (FRONT AXLES) 95-96 4X4-W/ BTB OB	0213-0198	-
SPORTSMAN 400 (FRONT AXLES) 95-96 4X4-W/ USA OB	0213-0199	-
SPORTSMAN 400 (FRONT AXLES) 97-01 4X4	0213-0198	-
SPORTSMAN 400 (REAR AXLES) 01-02 4X4	0213-0200	0213-0201
SPORTSMAN 400 (FRONT AXLES) 02-04 4X4	0213-0199	-
SPORTSMAN 400 (REAR AXLES) 03-05 4X4	0213-0202	0213-0201
SPORTSMAN 400 (FRONT AXLES) 05 4X4	0213-0204	0213-0496
SPORTSMAN 400 (FRONT AXLES) 08-10 4X4	0213-0497	0213-0442
XPLORER 400 95-96 4X4-W/ USA OB	0213-0199	-
XPLORER 400 97-98 4X4	0213-0198	-
XPLORER 400 99-02 4X4	0213-0199	-
MAGNUM 425 95-96 4X4-W/ BTB OB	0213-0198	-
MAGNUM 425 95-96 4X4-W/ USA OB	0213-0199	-
MAGNUM 425 95-96 6X6-W/ BTB OB	0213-0198	-
MAGNUM 425 95-96 6X6-W/ USA OB	0213-0199	-
MAGNUM 425 97-98 4X4	0213-0198	-
MAGNUM 425 97-98 6X6	0213-0198	-
XPEDITION 425 00-01 4X4	0213-0198	-
XPEDITION 425 02 4X4	0213-0199	-
SPORTSMAN 450 (FRONT AXLES) 06-07 4X4-AFTER 7/25/06	0213-0253	0213-0331
SPORTSMAN 450 (FRONT AXLES) 06-07 4X4-BEFORE 7/25/06	0213-0206	0213-0207
SPORTSMAN 450 (REAR AXLES) 06-07 4X4	0213-0205	0213-0498
DIESEL 455 (FRONT AXLES) 99-02 4X4	0213-0198	-
DIESEL 455 (REAR AXLES) 99-02 4X4	0213-0200	0213-0201
ATP 500 H.O. 04 4X4	0213-0199	-
ATP 500 H.O. 05 4X4	0213-0204	0213-0496
ATV PRO 500 02 4X4-PPS	0213-0206	-
BIG BOSS 500 1998 1999 6X6	0213-0198	-
LUH 500 02 6X6	0213-0199	-
MAGNUM 500 99-00 4X4	0213-0198	-
MAGNUM 500 01 4X4-EXC. HDS (VISCO-LOK)	0213-0198	-
MAGNUM 500 01 4X4-HDS (VISCO-LOK)	0213-0206	-
MAGNUM 500 02 2X4-HDS (VISCO-LOK)	0213-0199	-
MAGNUM 500 02 4X4-EXC. HDS (VISCO-LOK)	0213-0199	-
MAGNUM 500 02 4X4-HDS (VISCO-LOK)	0213-0206	-
MAGNUM 500 03 4X4-HDS (VISCO-LOK)	0213-0206	-
OUTLAW 500 (REAR AXLES) 06-07 2X4-IRS	0213-0204	-
OUTLAW 500 (REAR AXLES) 06-07 2X4-IRS	-	0213-0441
SCRAMBLER 500 97-98 4X4	0213-0198	-
SCRAMBLER 500 99-07 4X4	0213-0199	-
SPORTSMAN 500 (FRONT AXLES) 96 4X4-W/ BTB OB	0213-0198	-
SPORTSMAN 500 (FRONT AXLES) 96 4X4-W/ USA OB	0213-0199	-
SPORTSMAN 500 (FRONT AXLES) 97 4X4	0213-0199	-
SPORTSMAN 500 (FRONT AXLES) 98-01 4X4	0213-0198	-
SPORTSMAN 500 (FRONT AXLES) 98-01 6X6	0213-0198	-
SPORTSMAN 500 (FRONT AXLES) 02-04 4X4	0213-0199	-
SPORTSMAN 500 (FRONT AXLES) 02-04 6X6	0213-0199	-
SPORTSMAN 500 (FRONT AXLES) 05 4X4	0213-0204	0213-0496
SPORTSMAN 500 (FRONT AXLES) 05 6X6	0213-0199	-
SPORTSMAN 500 (FRONT AXLES) 06 4X4	0213-0206	0213-0207
SPORTSMAN 500 (FRONT AXLES) 06 6X6	0213-0199	-
SPORTSMAN 500 (FRONT AXLES) 07 4X4-AFTER 7/25/06	0213-0253	0213-0331
SPORTSMAN 500 (FRONT AXLES) 07 4X4-BEFORE 7/25/06	0213-0206	0213-0207
SPORTSMAN 500 (FRONT AXLES) 07 6X6	0213-0199	-
SPORTSMAN 500 (REAR AXLES) 99-02 4X4	0213-0200	0213-0201
SPORTSMAN 500 (REAR AXLES) 03-05 4X4	0213-0202	0213-0201
SPORTSMAN 500 (REAR AXLES) 06-07 4X4	0213-0205	0213-0498
SPORTSMAN 500 (REAR AXLES) 08-10 4X4	-	0213-0500
SPORTSMAN X2 500 (FRONT AXLES) 07 4X4-AFTER 7/25/06	0213-0253	0213-0331
SPORTSMAN X2 500 (FRONT AXLES) 07 4X4-BEFORE 7/25/06	0213-0206	0213-0207
SPORTSMAN X2 500 (REAR AXLES) 06-07 4X4	0213-0205	0213-0498
SPORTSMAN X2 500 (REAR AXLES) 08-09 4X4	-	0213-0500
XPLORER 500 97 4X4	0213-0199	-
OUTLAW 525 (REAR AXLES) 07-09 2X4-IRS	-	0213-0441
OUTLAW 525 (REAR AXLES) 07 2X4-IRS	0213-0204	-
SPORTSMAN X2 550 (FRONT AXLES) 10 4X4	0213-0499	0213-0443
SPORTSMAN X2 550 (REAR AXLES) 10 4X4	0213-0444	0213-0445
SPORTSMAN XP 550 (FRONT AXLES) 09-10 4X4	0213-0499	0213-0443
SPORTSMAN XP 550 (REAR AXLES) 09 4X4-EPS W/ ELECTRONIC POWER STEERING	0213-0444	0213-0445

CONTINUED ON NEXT PAGE

FITS MODEL	OUTBOARD PART #	INBOARD PART #
CV REBUILD KITS (CON'T)		
POLARIS (CON'T)		
SPORTSMAN XP 550 (REAR AXLES) 09 4X4-EXC. EPS	-	0213-0500
SPORTSMAN XP 550 (REAR AXLES) 10 4X4	0213-0444	0213-0445
SPORTSMAN 600 (FRONT AXLES) 03-04 4X4	0213-0199	-
SPORTSMAN 600 (FRONT AXLES) 05 4X4	0213-0204	0213-0496
SPORTSMAN 600 (REAR AXLES) 03-05 4X4	0213-0202	0213-0201
SPORTSMAN 700 (FRONT AXLES) 02-04 4X4	0213-0199	-
SPORTSMAN 700 (FRONT AXLES) 05 4X4	0213-0204	0213-0496
SPORTSMAN 700 (FRONT AXLES) 06-07 4X4-AFTER 7/25/06	0213-0253	0213-0331
SPORTSMAN 700 (FRONT AXLES) 06-07 4X4-BEFORE 7/25/06	0213-0206	0213-0207
SPORTSMAN 700 (REAR AXLES) 02-05 4X4	0213-0202	0213-0201
SPORTSMAN 700 (REAR AXLES) 06-07 4X4	0213-0205	0213-0498
SPORTSMAN MV7 (FRONT AXLES) 05 4X4	0213-0204	-
SPORTSMAN MV7 (FRONT AXLES) 06 4X4	0213-0206	0213-0207
SPORTSMAN MV7 (FRONT AXLES) 07 4X4-AFTER 7/25/06	0213-0253	0213-0331
SPORTSMAN MV7(FRONT AXLES) 07 4X4- BEFORE 7/25/06	0213-0206	0213-0207
SPORTSMAN MV7(FRONT AXLES) 07 6X6	0213-0199	-
SPORTSMAN MV7 (REAR AXLES) 05 4X4	0213-0202	0213-0201
SPORTSMAN MV7 (REAR AXLES) 06-07 4X4	0213-0205	0213-0201
SPORTSMAN 800 (FRONT AXLES) 05 4X4	0213-0204	0213-0496
SPORTSMAN 800 (FRONT AXLES) 06 4X4-OB HOUSING STAMPED *NEAPCO*	0213-0204	0213-0496
SPORTSMAN 800 (FRONT AXLES) 06 4X4-OB HOUSING STAMPED *GKN*	0213-0206	0213-0207
SPORTSMAN 800 (FRONT AXLES) 07 4X4-AFTER 7/25/06	0213-0253	0213-0331
SPORTSMAN 800 (FRONT AXLES) 07 4X4-BEFORE 7/25/06	0213-0206	0213-0207
SPORTSMAN 800 (REAR AXLES) 05 4X4	0213-0202	0213-0201
SPORTSMAN 800 (REAR AXLES) 06-07 4X4	0213-0205	0213-0498
SPORTSMAN 800 (REAR AXLES) 08 4X4	-	0213-0500
SPORTSMAN 800 (REAR AXLES) 09-10 4X4	-	0213-0500
SPORTSMAN 800 (REAR AXLES) 09-10 6X6	-	0213-0500
SPORTSMAN X2 800 (FRONT AXLES) 07 4X4-AFTER 7/25/06	0213-0253	0213-0331
SPORTSMAN X2 800 (FRONT AXLES) 07 4X4-BEFORE 7/25/06	0213-0206	0213-0207
SPORTSMAN X2 800 (REAR AXLES) 07 4X4	0213-0205	0213-0498
SPORTSMAN X2 800 (REAR AXLES) 08-09 4X4	-	0213-0500
SPORTSMAN 850 (REAR AXLES) 10 4X4	0213-0444	0213-0445
SPORTSMAN 850 (FRONT AXLES) 10 4X4	0213-0499	0213-0443
SPORTSMAN XP 850 (FRONT AXLES) 09-10 4X4	0213-0499	0213-0443
SPORTSMAN XP 850 (REAR AXLES) 10 4X4	-	0213-0500
RANGER (FRONT AXLES) 99-01 SERIES 99	0213-0199	-
RANGER (FRONT AXLES) 02 SERIES 10	0213-0199	-
RANGER (FRONT AXLES) 03-04 SERIES 11	0213-0199	-
RANGER 400 (FRONT AXLES) 10-13	0213-0332	-
RANGER 500 (FRONT AXLES) 04-05 4X4	0213-0206	0213-0207
RANGER 500 (FRONT AXLES) 04-05 6X6	0213-0199	-
RANGER 500 (FRONT AXLES) 06-07 4X4	0213-0204	-
RANGER 500 (FRONT AXLES) 11-13	0213-0332	-
RANGER 500 (REAR AXLES) 05-06 2X4	0213-0202	0213-0498
RANGER 500 (REAR AXLES) 05-06 4X4	0213-0202	0213-0498
RANGER 500 (REAR AXLES) 07 2X4	0213-0202	0213-0498
RANGER 500 (REAR AXLES) 07 4X4-AFTER 8/26/06	0213-0205	0213-0498
RANGER 500 (REAR AXLES) 07 4X4-BEFORE 8/26/06	0213-0202	0213-0498
RANGER 500 (REAR AXLES) 10 4X4	-	0213-0500
RANGER 500 (REAR AXLES) 08-09 2X4	-	0213-0500
RANGER 500 (REAR AXLES) 08-09 4X4	-	0213-0500
RANGER 500 (FRONT AXLES) 06-07 4X4	-	0213-0496
RANGER 700 (FRONT AXLES) 06-07 6X6	0213-0204	-
RANGER 700 (MIDDLE AXLES) 06-07 6X6	0213-0202	0213-0201
RANGER 700 (MIDDLE AXLES) 06-07 6X6	-	0213-0498
RANGER 700 (MIDDLE AXLES) 08-09 6X6	-	0213-0500
RANGER 700 (FRONT AXLES) 06-07 6X6	-	0213-0496
RANGER 700 (REAR AXLES) 08-09 4X4	-	0213-0500
RANGER XP 700 (FRONT AXLES) 05 4X4	0213-0206	0213-0207
RANGER XP 700 (FRONT AXLES) 06-07 4X4	0213-0204	-
RANGER XP 700 (REAR AXLES) 05-06 4X4	0213-0202	0213-0201
RANGER XP 700 (REAR AXLES) 07 4X4-AFTER 8/26/06	0213-0205	0213-0201
RANGER XP 700 (REAR AXLES) 07 4X4-BEFORE 8/26/06	0213-0202	0213-0201
RANGER XP 700 (REAR AXLES) 07 4X4-AFTER 8/26/06	-	0213-0498
RANGER XP 700 (REAR AXLES) 07 4X4-BEFORE 8/26/06	-	0213-0498
RANGER XP 700 (REAR AXLES) 05-06 4X4	-	0213-0498
RANGER XP 700 (REAR AXLES) 08-09 4X4	-	0213-0500
RANGER XP 700 (FRONT AXLES) 06-07 4X4	-	0213-0496
RANGER 800 (FRONT AXLES) 11-13	0213-0444	0213-0445
RANGER 800 (MIDDLE AXLES) 10 6X6	-	0213-0500
RANGER 800 (REAR AXLES) 10 4X4	-	0213-0500
RANGER 800 (REAR AXLES) 10 6X6	-	0213-0500

FITS MODEL	OUTBOARD PART #	INBOARD PART #
CV REBUILD KITS (CON'T)		
POLARIS (CON'T)		
RANGER 900 (FRONT AXLES) DIESEL 13	0213-0444	0213-0445
RANGER 900 (FRONT AXLES) 13	0213-0332	-
RZR 570 (FRONT AXLES) 12-13	0213-0332	-
RZR 800 (FRONT AXLES) 08-13 4X4	0213-0332	-
RZR S "SPORT" (REAR AXLES) 09-10 4X4	-	0213-0500
SUZUKI		
QUAD RUNNER 250 87 4X4	0213-0208	-
QUAD RUNNER 250 1988 1996 4X4	0213-0208	0213-0334
QUAD RUNNER 250 97-98 4X4-W/ 68LAC IB	0213-0208	0213-0333
QUAD RUNNER 250 97-98 4X4-W/ 71LAC IB	0213-0208	0213-0334
QUAD RUNNER 250 99-02 4X4	0213-0208	0213-0333
QUAD RUNNER 300 94-95 4X4	0213-0208	0213-0334
KING QUAD 300 91-93 4X4	0213-0208	0213-0334
KING QUAD 300 96-98 4X4-W/ 68LAC IB	0213-0208	0213-0333
KING QUAD 300 96-98 4X4-W/ 71LAC IB	0213-0208	0213-0334
KING QUAD 300 99-02 4X4	0213-0208	0213-0333
EIGER 400 02 4X4	0213-0208	0213-0333
EIGER 400 03-04 4X4-W/ 68LAC 0B	0213-0208	0213-0333
EIGER 400 03-04 4X4-W/ UJ68 0B	0213-0210	0213-0211
EIGER 400 05-07 4X4	0213-0208	0213-0211
KING QUAD 400 08-11 4X4	0213-0506	-
KING QUAD 450 (FRONT AXLES) 07-10 4X4	0213-0505	0213-0502
KING QUAD 450 (REAR AXLES) 07-10 4X4	-	0213-0502
KING QUAD 450 (REAR AXLES) 09-10 4X4	0213-0505	-
KING QUAD 500 (FRONT AXLES) 09-11 4X4-EXC. POWER STEERING	0213-0505	0213-0502
KING QUAD 500 (FRONT AXLES) 09-11 4X4-W/ POWER STEERING	0213-0507	-
KING QUAD 500 (REAR AXLES) 09 4X4	0213-0504	-
KING QUAD 500 (REAR AXLES) 11 4X4	0213-0503	0213-0502
QUAD MASTER 500 99-02 4X4	0213-0208	0213-0333
QUAD RUNNER 500 98-02 4X4	0213-0208	0213-0333
VINSON 500 02 4X4-AT	0213-0208	0213-0333
VINSON 500 03-05 4X4	0213-0210	0213-0211
VINSON 500 06 4X4	0213-0208	0213-0211
Q.U.V. 620 (UTILITY VEHICLE) 05 4X4	0213-0208	-
KING QUAD 700 (FRONT AXLES) 05-06 4X4	-	0213-0501
KING QUAD 700 (FRONT AXLES) 05 4X4-AT	0213-0209	-
KING QUAD 700 (REAR AXLES) 05 4X4-AT	0213-0209	0213-0334
KING QUAD 700 (REAR AXLES) 07 4X4-OB HOUSING STAMPED *71LAC*- INNER RACE W/ 26 TEETH	-	0213-0502
KING QUAD 700 (REAR AXLES) 07 4X4-OB HOUSING STAMPED *UJ71A*- INNER RACE W/ 26 TEETH	-	0213-0502
TWIN PEAKS 700 04-05 4X4	0213-0208	0213-0211
KING QUAD 700 (REAR AXLES) 07 4X4-OB HOUSING STAMPED *UJ71A*- INNER RACE W/ 26 TEETH	0213-0503	-
KING QUAD 750 (FRONT AXLES) 08 4X4	0213-0505	0213-0502
KING QUAD 750 (FRONT AXLES) 09-11 4X4-EXC. POWER STEERING	0213-0505	0213-0502
KING QUAD 750 (FRONT AXLES) 09-11 4X4-W/ POWER STEERING	0213-0507	-
KING QUAD 750 (REAR AXLES) 08 4X4	0213-0503	0213-0502
KING QUAD 750 (REAR AXLES) 09-12 4X4-EXC. POWER STEERING	0213-0503	0213-0502
KING QUAD 750 (REAR AXLES) 09-12 4X4-W/ POWER STEERING	0213-0504	-
YAMAHA		
TIMBERWOLF 250 94-00 4X4	0213-0212	0213-0213
BIG BEAR 350 87-96 4X4	0213-0212	0213-0213
BIG BEAR 350 97 4X4-IB HOUSING STAMPED *68 AC*	0213-0212	0213-0213
BIG BEAR 350 97 4X4-IB HOUSING STAMPED *68 LAC*	0213-0212	0213-0214
BIG BEAR 350 98-99 4X4	0213-0212	0213-0214
BIG BEAR 400 (FRONT AXLES) 00-01 4X4-EXC. IRS	0213-0212	0213-0214
BIG BEAR 400 (FRONT AXLES) 02-06 4X4-EXC. IRS	0213-0212	0213-0213
BIG BEAR 400 (FRONT AXLES) 07-08 4X4-W/ IRS	0213-0508	0213-0217
BIG BEAR 400 (REAR AXLES) 07-08 4X4-W/ IRS	0213-0212	0213-0214
BRUIN 350 04-06 4X4	0213-0212	0213-0213
GRIZZLY 350 (FRONT AXLES) 07-08 4X4-EXC. IRS	0213-0212	0213-0213
GRIZZLY 350 (FRONT AXLES) 07-08 4X4-W/ IRS	0213-0508	0213-0217
GRIZZLY 350 (REAR AXLES) 07-08 4X4-W/ IRS	0213-0212	0213-0214
WOLVERINE 350 95-05 4X4	0213-0212	0213-0214
GRIZZLY 400 (FRONT AXLES) 07 4X4	0213-0212	0213-0213
GRIZZLY 400 (REAR AXLES) 07 4X4	0213-0212	0213-0214
KODIAK 400 (FRONT AXLES) 93-98 4X4	0213-0212	0213-0213
KODIAK 400 (FRONT AXLES) 99 4X4	0213-0212	0213-0214
KODIAK 400 (FRONT AXLES) 00-06 4X4	0213-0212	0213-0213
KODIAK 400 (REAR AXLES) 05-06 4X4	0213-0212	0213-0214
GRIZZLY 450 (FRONT AXLES) 07 4X4	0213-0212	0213-0214
GRIZZLY 450 (FRONT AXLES) 08 4X4	0213-0508	0213-0217
GRIZZLY 450 (REAR AXLES) 07-08 4X4	0213-0212	0213-0214
KODIAK 450 (FRONT AXLES) 03-06 4X4	0213-0212	0213-0214

PLOWS
WINCHES
UTV
RACKS
LUGGAGE
BODY
CONTROLS
ELECTRICAL
WHEELS & TIRES
SUSPENSION & DRIVE
ENGINE
NRA BY MOOSE
RIDER
TOWING
GARAGE
PROMO

FITS MODEL	OUTBOARD PART #	INBOARD PART #
CV REBUILD KITS (CON'T)		
YAMAHA (CON'T)		
KODIAK 450 (REAR AXLES) 05-06 4X4-(REAR AXLES)	0213-0212	0213-0214
RHINO 450 (FRONT AXLES) 06 4X4	0213-0218	0213-0217
RHINO 450 (REAR AXLES) 06 4X4	0213-0218	0213-0215
WOLVERINE 450 SPORT 06-08 4X4	0213-0212	0213-0213
GRIZZLY 600 98-01 4X4	-	0213-0215
GRIZZLY 660 (FRONT AXLES) 02 4X4	0213-0212	0213-0214
GRIZZLY 660 (FRONT AXLES) 03 4X4-08 HOUSING STAMPED *68 LAC*	0213-0212	0213-0217
GRIZZLY 660 (FRONT AXLES) 03 4X4-08 HOUSING STAMPED *UJ 68*	0213-0216	0213-0217
GRIZZLY 660 (FRONT AXLES) 04-08 4X4	0213-0212	0213-0217
GRIZZLY 660 (REAR AXLES) 03 4X4	0213-0216	0213-0214
GRIZZLY 660 (REAR AXLES) 04-08 4X4	0213-0212	0213-0214
GRIZZLY 700 (FRONT AXLES) 07-08 4X4	0213-0335	0213-0336
GRIZZLY 700 (REAR AXLES) 07-08 4X4	0213-0335	0213-0336
RHINO 660 (FRONT AXLES) 04 4X4	0213-0212	0213-0217
RHINO 660 (FRONT AXLES) 05-07 4X4	0213-0218	0213-0217
RHINO 660 (REAR AXLES) 04 4X4	0213-0212	0213-0214
RHINO 660 (REAR AXLES) 05-06 4X4	0213-0218	0213-0215
RHINO 660 (REAR AXLES) 07 4X4	0213-0218	-
RHINO 660 (REAR AXLES) 07 4X4	-	0213-0446
RHINO 700 (FRONT AXLES) 08 4X4	0213-0218	0213-0336
RHINO 700 (REAR AXLES) 08 4X4	0213-0218	-
RHINO 700 (REAR AXLES) 08-09 4X4	-	0213-0446

FRONT OUTBOARD/INBOARD CV JOINT KITS > \$112.95-\$154.95

Heavy-duty fully assembled outboard joint and boot assembly, comes with heavy-duty puncture resistant boot, clamps and grease. Made in the USA.



FITS MODEL	OUTBOARD PART #	INBOARD PART #
FRONT OUTBOARD/INBOARD CV JOINT KITS		
ARCTIC CAT		
250 05 4X4	0213-0179	0213-0478
250 02-04 4X4	0213-0156	0213-0478
250 01 4X4-INNER RACE W/ 18 TEETH	0213-0299	-
250 01 4X4-INNER RACE W/ 19 TEETH	0213-0156	0213-0477
300 05 4X4	0213-0179	0213-0478
300 02-04 4X4	0213-0156	0213-0478
300 01 4X4-INNER RACE W/ 18 TEETH	0213-0299	-
300 01 4X4-INNER RACE W/ 19 TEETH	0213-0156	0213-0477
300 98-00 4X4	0213-0299	-
375 02 4X4	0213-0156	0213-0478
400 06-08 4X4-EXC. FIS	0213-0300	0213-0480
400 06-08 4X4-FIS-LEFT SIDE-MACHINES WITH FULLY INDEPENDENT SUSPENSION	0213-0300	0213-0481
400 06-08 4X4-FIS-RIGHT SIDE-MACHINES WITH FULLY INDEPENDENT SUSPENSION	0213-0300	0213-0480
400 05 4X4-EXC. FIS	0213-0179	0213-0478
400 05 4X4-FIS-LEFT SIDE-MACHINES WITH FULLY INDEPENDENT SUSPENSION	0213-0179	0213-0479
400 05 4X4-FIS-RIGHT SIDE-MACHINES WITH FULLY INDEPENDENT SUSPENSION	0213-0179	0213-0478
400 02-04 4X4	0213-0156	0213-0478
400 01 4X4-INNER RACE W/ 18 TEETH	0213-0299	-
400 01 4X4-INNER RACE W/ 19 TEETH	0213-0156	0213-0477
400 98-00 4X4	0213-0299	-
454 98 4X4-FROM #13001	0213-0299	-
500 07-08 4X4-LEFT SIDE	0213-0300	0213-0481
500 07-08 4X4-RIGHT SIDE	0213-0300	0213-0480
500 06 4X4-FIS-LEFT SIDE-MACHINES WITH FULLY INDEPENDENT SUSPENSION	0213-0300	0213-0481
500 06 4X4-FIS-RIGHT SIDE-MACHINES WITH FULLY INDEPENDENT SUSPENSION	0213-0300	0213-0480
500 06 4X4-TBX-LEFT SIDE	0213-0300	0213-0481
500 06 4X4-TBX-RIGHT SIDE	0213-0300	0213-0480
500 06 4X4-TRV	0213-0300	0213-0480
500 05 4X4-FIS-LEFT SIDE-MACHINES WITH FULLY INDEPENDENT SUSPENSION	0213-0179	0213-0479
500 05 4X4-FIS-RIGHT SIDE-MACHINES WITH FULLY INDEPENDENT SUSPENSION	0213-0179	0213-0478
500 02-04 4X4	0213-0156	0213-0478
500 01 4X4-INNER RACE W/ 18 TEETH	0213-0299	-

FITS MODEL	OUTBOARD PART #	INBOARD PART #
FRONT OUTBOARD/INBOARD CV JOINT KITS (CON'T)		
ARCTIC CAT (CON'T)		
500 01 4X4-INNER RACE W/ 19 TEETH	0213-0156	0213-0477
500 98-00 4X4	0213-0299	-
650 06-08 4X4-LEFT SIDE-EXC. PROWLER XT	0213-0300	0213-0481
650 06-08 4X4-LEFT SIDE-PROWLER XT	0213-0300	0213-0480
650 06-08 4X4-RIGHT SIDE-EXC. PROWLER XT	0213-0300	0213-0480
650 06-08 4X4-RIGHT SIDE-PROWLER XT	0213-0300	0213-0481
650 05 4X4-LEFT SIDE	0213-0179	0213-0479
650 05 4X4-RIGHT SIDE	0213-0179	0213-0478
650 04 4X4-LEFT SIDE	0213-0156	0213-0479
650 04 4X4-RIGHT SIDE	0213-0156	0213-0478
700 07-08 4X4-LEFT SIDE	0213-0300	0213-0481
700 07-08 4X4-RIGHT SIDE	0213-0300	0213-0480
CAN-AM		
OUTLANDER 330 04-05 4X4	0213-0304	-
OUTLANDER 400 06-08 4X4	0213-0307	-
OUTLANDER 400 03-05 4X4	0213-0304	-
OUTLANDER 500 07-08 4X4	0213-0307	-
QUEST 500 02-04 4X4	0213-0306	-
RENEGADE 500 08 4X4	0213-0307	-
TRAXTER 500 02-05 4X4	0213-0306	-
TRAXTER 500 01 4X4-7459/7460/7467/7468/7472/7481	0213-0306	-
TRAXTER 500 01 4X4-AUTOSHIFT 7431/7432	0213-0305	-
TRAXTER 500 01 4X4-EXC. 7459/7460/7467/7468/7472/7481	0213-0305	-
TRAXTER 500 01 4X4-EXC. AUTOSHIFT 7431/7432	0213-0306	-
TRAXTER 500 01 4X4-FOOTSHIFT 7439/7440	0213-0305	-
TRAXTER 500 01 4X4-FOOTSHIFT 7473/7474	0213-0306	-
TRAXTER 500 01 4X4-XL 7448-FROM SERIAL NO. V000709	0213-0306	-
TRAXTER 500 01 4X4-XL 7448-UP TO SERIAL NO. V000708	0213-0305	-
TRAXTER 500 01 4X4-XL 7467/7468/7472/7481/7489	0213-0306	-
TRAXTER 500 99-00 4X4	0213-0305	-
OUTLANDER 650 06-08 4X4	0213-0307	-
QUEST 650 02-04 4X4	0213-0306	-
OUTLANDER 800 06-08 4X4	0213-0307	-
RENEGADE 800 07-08 4X4	0213-0307	-
HONDA		
TRX300 FOURTRAX 88-00 4X4	0213-0046	-
TRX350 FOURTRAX 87 4X4	0213-0046	-
TRX350 RANCHER 06 4X4	0213-0096	0213-0467
TRX350 RANCHER 00-05 4X4	0213-0096	-
TRX350D FOREMAN 87-89 4X4	0213-0046	-
TRX400 FOREMAN 95-03 4X4	0213-0046	-
TRX400 RANCHER 04-07 4X4	0213-0096	-
TRX400 RANCHER 95-03 4X4	0213-0046	-
TRX420 RANCHER 09 4X4-EXC. AT W/ POWER STEERING	0213-0399	-
TRX420 RANCHER 07-08 4X4	0213-0399	-
TRX450 FOREMAN 98-04 4X4	0213-0046	0213-0466
TRX500 FOREMAN 08-09 4X4	0213-0399	0213-0467
TRX500 FOREMAN 07 4X4-ES W/ POWER STEERING ES-ELECTRONIC SHIFT PROGRAM	0213-0399	0213-0467
TRX500 FOREMAN 07 4X4-EXC. ES W/ POWER STEERING ES-ELECTRONIC SHIFT PROGRAM	0213-0095	0213-0467
TRX500 FOREMAN 05-06 4X4	0213-0095	0213-0467
TRX500 RUBICON 08-09 4X4	0213-0399	0213-0467
TRX500 RUBICON 05-07 4X4	0213-0095	0213-0467
TRX500 RUBICON 01-04 4X4	0213-0095	0213-0466
TRX650 RINCON 05 4X4	0213-0095	0213-0467
TRX650 RINCON 03-04 4X4	0213-0095	-
TRX680 RINCON 08-09 4X4	0213-0399	0213-0467
TRX680 RINCON 06-07 4X4	0213-0095	0213-0467
JOHN DEERE		
BUCK 04-06 4X4	0213-0306	-
KAWASAKI		
BAYOU 300 89-04 4X4	0213-0050	0213-0404
PRAIRIE 360 09-10 4X4-LEFT SIDE	0213-0376	0213-0486
PRAIRIE 360 09-10 4X4-RIGHT SIDE	0213-0376	0213-0485
PRAIRIE 360 06-08 4X4-LEFT SIDE	0213-0097	0213-0486
PRAIRIE 360 06-08 4X4-RIGHT SIDE	0213-0097	0213-0485
PRAIRIE 360 03-05 4X4-LEFT SIDE	0213-0301	-
PRAIRIE 360 03-05 4X4-RIGHT SIDE	0213-0301	-
BAYOU 400 93-99 4X4	0213-0050	0213-0404
PRAIRIE 400 97-02 4X4	0213-0050	0213-0484
PRAIRIE 650 02-03 4X4-LEFT SIDE	0213-0301	-
PRAIRIE 650 02-03 4X4-RIGHT SIDE	0213-0301	-
BRUTE FORCE 650 10 4X4-LEFT SIDE	0213-0376	0213-0486
BRUTE FORCE 650 10 4X4-RIGHT SIDE	0213-0376	0213-0485

FITS MODEL	OUTBOARD PART #	INBOARD PART #
FRONT OUTBOARD/INBOARD CV JOINT KITS (CON'T)		
KAWASAKI (CON'T)		
BRUTE FORCE 650 05-09 4X4-LEFT SIDE	0213-0097	0213-0486
BRUTE FORCE 650 05-09 4X4-RIGHT SIDE	0213-0097	0213-0485
BRUTE FORCE 650I 06-09 4X4-LEFT SIDE	0213-0302	0213-0486
BRUTE FORCE 650I 06-09 4X4-RIGHT SIDE	0213-0302	0213-0485
PRAIRIE 700 04-06 4X4-LEFT SIDE	0213-0097	0213-0486
PRAIRIE 700 04-06 4X4-RIGHT SIDE	0213-0097	0213-0485
BRUTE FORCE 750I 08-10 4X4-LEFT SIDE	0213-0374	-
BRUTE FORCE 750I 08-10 4X4-RIGHT SIDE	0213-0374	0213-0488
BRUTE FORCE 750I 05-07 4X4-LEFT SIDE	0213-0302	0213-0486
BRUTE FORCE 750I 05-07 4X4-RIGHT SIDE	0213-0302	0213-0485
MULE 610 10 4WD-400CC	0213-0483	0213-0485
MULE 610 09 4WD-400CC-FROM VIN #JK1AFAE1 9B547192	0213-0483	0213-0485
MULE 610 09 4WD-400CC-TO VIN #JK1AFAE1 9B547191	0213-0483	0213-0484
MULE 610 05-08 4WD-400CC	0213-0483	0213-0484
MULE 2510 00-02 4WD-620CC & 950CC DIESEL	0213-0183	0213-0404
MULE 2510 93-99 4WD-620CC & 950CC DIESEL	0213-0183	-
MULE 3010 01-08 4WD-620CC & 950CC DIESEL	0213-0183	0213-0404
MULE 4010 09-10 4WD-620CC & 950CC DIESEL	0213-0377	-
TERYX 750 09 4X4-FROM SERIAL # 9B500713	0213-0378	0213-0487
POLARIS		
XPLORER 250 00-02 4X4	0213-0049	-
250 93 4X4	0213-0287	-
250 93 6X6	0213-0287	-
BIG BOSS 250 92 6X6-W/ USA OB	0213-0287	-
TRAIL BOSS 250 92 4X4-W/ USA OB	0213-0287	-
TRAIL BOSS 250 91 4X4	0213-0287	-
300 96 4X4	0213-0287	-
300 95 4X4	0213-0288	-
300 94 4X4	0213-0287	-
300 94 6X6	0213-0287	-
HAWKEYE 300 06-07 4X4	0213-0294	0213-0470
SPORTSMAN 300 08-10 4X4	0213-0294	0213-0470
XPLORER 300 98-99 4X4	0213-0047	-
XPLORER 300 97 4X4-FROM 1/1/97	0213-0047	-
XPLORER 300 97 4X4-TO 1/1/97	0213-0288	-
XPLORER 300 96 4X4	0213-0288	-
XPEDITION 325 00-02 4X4	0213-0047	-
MAGNUM 325 01-02 4X4-EXC. HDS (VISCO-LOK)	0213-0047	-
MAGNUM 325 01-02 4X4-HDS (VISCO-LOK)-LEFT SIDE	0213-0291	0213-0468
MAGNUM 325 01-02 4X4-HDS (VISCO-LOK)-RIGHT SIDE	0213-0291	0213-0469
MAGNUM 325 00 4X4	0213-0047	-
MAGNUM 330 05-06 4X4	0213-0258	0213-0259
MAGNUM 330 04 4X4-EXC. HDS (VISCO-LOK)	0213-0180	-
MAGNUM 330 04 4X4-HDS (VISCO-LOK)-LEFT SIDE	0213-0292	0213-0468
MAGNUM 330 04 4X4-HDS (VISCO-LOK)-RIGHT SIDE	0213-0292	0213-0469
MAGNUM 330 03 4X4-EXC. HDS (VISCO-LOK)	0213-0180	-
MAGNUM 330 03 4X4-HDS (VISCO-LOK)-LEFT SIDE	0213-0291	0213-0468
MAGNUM 330 03 4X4-HDS (VISCO-LOK)-RIGHT SIDE	0213-0291	0213-0469
ATP 330 05 4X4	0213-0258	0213-0259
ATP 330 04 4X4	0213-0180	-
SPORTSMAN 335 99-00 4X4	0213-0047	-
350L 93 4X4	0213-0287	-
350L 93 6X6	0213-0287	-
TRAIL BOSS 350 92 4X4-W/ USA OB	0213-0287	-
SPORTSMAN 400 08-10 4X4	0213-0294	0213-0470
SPORTSMAN 400 05 4X4	0213-0258	0213-0259
SPORTSMAN 400 04 4X4-W/ FEMALE SPLINE ON IB YOKE	0213-0049	-
SPORTSMAN 400 04 4X4-W/ MALE SPLINE ON IB YOKE	0213-0180	-
SPORTSMAN 400 02-03 4X4	0213-0049	-
SPORTSMAN 400 01 4X4	0213-0047	-
SPORTSMAN 400 97 4X4	0213-0047	-
SPORTSMAN 400 95-96 4X4-W/ BTB OB	0213-0288	-
SPORTSMAN 400 95-96 4X4-W/ USA OB	0213-0289	-
SPORTSMAN 400 94 4X4	0213-0287	-
SCRAMBLER 400 00-02 4X4	0213-0049	-
SCRAMBLER 400 99 4X4-W/ BTB OB	0213-0047	-
SCRAMBLER 400 99 4X4-W/ USA OB	0213-0049	-
SCRAMBLER 400 98 4X4	0213-0047	-
SCRAMBLER 400 97 4X4	0213-0288	-
SCRAMBLER 400 95-96 4X4-W/ BTB OB	0213-0288	-
SCRAMBLER 400 95-96 4X4-W/ USA OB	0213-0289	-
400L 95 6X6-W/ BTB OB	0213-0288	-
400L 95 6X6-W/ USA OB	0213-0287	-
400L 94 4X4	0213-0287	-
400L 94 6X6	0213-0287	-

FITS MODEL	OUTBOARD PART #	INBOARD PART #
FRONT OUTBOARD/INBOARD CV JOINT KITS (CON'T)		
POLARIS (CON'T)		
BIG BOSS 400L 97 6X6-FROM 1/1/97	0213-0047	-
BIG BOSS 400L 97 1997 6X6-TO 1/1/97	0213-0288	-
XPLORER 400 99-02 4X4	0213-0049	-
XPLORER 400 98 4X4	0213-0047	-
XPLORER 400 97 4X4-FROM 1/1/97	0213-0047	-
XPLORER 400 97 4X4-TO 1/1/97	0213-0288	-
XPLORER 400 95-96 4X4-W/ BTB OB	0213-0288	-
XPLORER 400 95-96 4X4-W/ USA OB	0213-0289	-
XPEDITION 425 02 4X4	0213-0049	-
XPEDITION 425 00-01 4X4	0213-0047	-
MAGNUM 425 98 4X4	0213-0047	-
MAGNUM 425 97 4X4-FROM 1/1/97	0213-0047	-
MAGNUM 425 97 4X4-TO 1/1/97	0213-0288	-
MAGNUM 425 97 6X6-FROM 1/1/97	0213-0047	-
MAGNUM 425 97 6X6-TO 1/1/97	0213-0288	-
MAGNUM 425 95-96 4X4-W/ BTB OB	0213-0288	-
MAGNUM 425 95-96 4X4-W/ USA OB	0213-0289	-
MAGNUM 425 95-96 6X6-W/ BTB OB	0213-0288	-
MAGNUM 425 95-96 6X6-W/ USA OB	0213-0289	-
SPORTSMAN 450 07 4X4-AFTER 7/25/06	0213-0257	0213-0471
SPORTSMAN 450 07 4X4-BEFORE 7/25/06	0213-0292	-
SPORTSMAN 450 06 4X4	0213-0292	-
XPLORER 500 97 4X4	0213-0049	-
ATP 500 H.O. 05 4X4	0213-0258	0213-0259
ATP 500 H.O. 04 4X4	0213-0180	-
BIG BOSS 500 98-99 6X6	0213-0047	-
DIESEL 99-02 4X4	0213-0047	-
MAGNUM 500 03 4X4-HDS (VISCO-LOK)-LEFT SIDE	0213-0292	0213-0468
MAGNUM 500 03 4X4-HDS (VISCO-LOK)-RIGHT SIDE	0213-0292	0213-0469
MAGNUM 500 02 4X4-EXC. HDS (VISCO-LOK)	0213-0155	-
MAGNUM 500 02 4X4-HDS (VISCO-LOK)-LEFT SIDE	0213-0291	0213-0468
MAGNUM 500 02 4X4-HDS (VISCO-LOK)-RIGHT SIDE	0213-0291	0213-0469
MAGNUM 500 01 4X4-EXC. HDS (VISCO-LOK)	0213-0047	-
MAGNUM 500 01 4X4-HDS (VISCO-LOK)-LEFT SIDE	0213-0291	0213-0468
MAGNUM 500 01 4X4-HDS (VISCO-LOK)-RIGHT SIDE	0213-0291	0213-0469
MAGNUM 500 99-00 4X4	0213-0047	-
SCRAMBLER 500 10 4X4	0213-0257	0213-0471
SCRAMBLER 500 99-09 4X4	0213-0049	-
SCRAMBLER 500 98 4X4	0213-0047	-
SCRAMBLER 500 97 4X4-FROM 1/1/97	0213-0047	-
SCRAMBLER 500 97 4X4-TO 1/1/97	0213-0288	-
SPORTSMAN 500 09-10 4X4	0213-0257	0213-0471
SPORTSMAN 500 08 4X4	0213-0257	0213-0471
SPORTSMAN 500 08 6X6	0213-0049	-
SPORTSMAN 500 07 4X4-AFTER 7/25/06	0213-0257	0213-0471
SPORTSMAN 500 07 4X4-BEFORE 7/25/06	0213-0292	-
SPORTSMAN 500 07 6X6	0213-0049	-
SPORTSMAN 500 06 4X4	0213-0292	-
SPORTSMAN 500 06 6X6	0213-0049	-
SPORTSMAN 500 05 4X4	0213-0258	0213-0259
SPORTSMAN 500 05 6X6	0213-0049	-
SPORTSMAN 500 04 4X4-W/ FEMALE SPLINE ON IB YOKE	0213-0049	-
SPORTSMAN 500 04 4X4-W/ MALE SPLINE ON IB YOKE	0213-0180	-
SPORTSMAN 500 04 6X6	0213-0049	-
SPORTSMAN 500 02-03 4X4	0213-0049	-
SPORTSMAN 500 02-03 6X6	0213-0049	-
SPORTSMAN 500 00-01 4X4	0213-0047	-
SPORTSMAN 500 00-01 6X6	0213-0047	-
SPORTSMAN 500 98-99 4X4	0213-0047	-
SPORTSMAN 500 97 4X4	0213-0049	-
SPORTSMAN 500 96 4X4-W/ BTB OB	0213-0288	-
SPORTSMAN 500 96 4X4-W/ USA OB	0213-0289	-
SPORTSMAN X2 500 08-09 4X4	0213-0257	0213-0471
SPORTSMAN X2 500 06-07 4X4-AFTER 7/25/06	0213-0257	0213-0471
SPORTSMAN X2 500 06-07 4X4-BEFORE 7/25/06	0213-0292	-
SPORTSMAN X2 550 10 4X4	0213-0432	0213-0473
SPORTSMAN XP 550 09-10 4X4	0213-0432	0213-0473
SPORTSMAN 600 05 4X4	0213-0258	0213-0259
SPORTSMAN 600 03-04 4X4	0213-0180	-
SPORTSMAN 700 07 4X4-AFTER 7/25/06	0213-0257	0213-0471
SPORTSMAN 700 07 4X4-BEFORE 7/25/06	0213-0292	-
SPORTSMAN 700 06 4X4	0213-0292	-
SPORTSMAN 700 05 4X4	0213-0258	0213-0259
SPORTSMAN 700 03-04 4X4	0213-0180	-
SPORTSMAN 700 02 4X4-FROM 5/1/02	0213-0180	-

CONTINUED ON NEXT PAGE

PLOWS
WINCHES
UTV
RACKS
LUGGAGE
BODY
CONTROLS
ELECTRICAL
WHEELS & TIRES
SUSPENSION & DRIVE
ENGINE
NRA BY MODEL
RIDER
TOWING
GARAGE
PROMO

FITS MODEL	OUTBOARD PART #	INBOARD PART #
FRONT OUTBOARD/INBOARD CV JOINT KITS (CON'T)		
POLARIS (CON'T)		
SPORTSMAN 700 02 4X4-TO 5/1/02	0213-0155	-
SPORTSMAN 800 08-10 4X4	0213-0257	0213-0471
SPORTSMAN 800 07 4X4-AFTER 7/25/06	0213-0257	0213-0471
SPORTSMAN 800 07 4X4-BEFORE 7/25/06	0213-0292	-
SPORTSMAN 800 06 4X4-08 HOUSING STAMPED *GKN*	0213-0292	-
SPORTSMAN 800 06 4X4-08 HOUSING STAMPED *NEAPCO*	0213-0258	0213-0259
SPORTSMAN 800 05 4X4	0213-0258	0213-0259
SPORTSMAN X2 800 08-09 4X4	0213-0257	0213-0471
SPORTSMAN X2 800 07 4X4-AFTER 7/25/06	0213-0257	0213-0471
SPORTSMAN X2 800 07 4X4-BEFORE 7/25/06	0213-0292	-
SPORTSMAN XP 850 09-10 4X4	0213-0432	0213-0473
RANGER 03-04 4X4-SERIES 11	0213-0155	-
RANGER 03-04 6X6-SERIES 11	0213-0155	-
RANGER 02 4X4-SERIES 10	0213-0155	-
RANGER 02 6X6-SERIES 10	0213-0155	-
RANGER 400 10 4X4	0213-0435	0213-0474
RANGER 500 09-10 4X4	0213-0434	0213-0471
RANGER 500 08 4X4	0213-0433	0213-0472
RANGER 500 06-07 4X4	0213-0256	0213-0259
RANGER 500 04-05 4X4	0213-0291	-
RANGER 500 04-05 6X6	0213-0155	-
RANGER 700 08-09 4X4	0213-0433	0213-0472
RANGER 700 08-09 6X6	0213-0433	0213-0472
RANGER 700 06-07 6X6	0213-0256	0213-0259
RANGER 700 (MIDDLE AXLES) 09 6X6	0213-0438	0213-0447
RANGER 700 (MIDDLE AXLES) 08 6X6	0213-0436	0213-0447
RANGER 700 (MIDDLE AXLES) 06-07 6X6	0213-0053	-
RANGER 800 10 4X4	0213-0434	0213-0471
RANGER 800 10 6X6	0213-0434	0213-0471
RANGER 800 (MIDDLE AXLES) 10 6X6	0213-0438	0213-0447
RANGER XP 700 09 4X4	0213-0434	0213-0471
RANGER XP 700 08 4X4	0213-0433	0213-0472
RANGER XP 700 06-07 4X4	0213-0256	0213-0259
RANGER XP 700 05 4X4	0213-0291	-
RZR 08-10 4X4	0213-0296	0213-0402
RZR S "SPORT" 09-10 4X4	0213-0296	0213-0402
SUZUKI		
QUAD RUNNER 250 87-02 4X4	0213-0181	-
KING QUAD 300 91-02 4X4	0213-0181	-
QUAD RUNNER 300 94-95 4X4	0213-0181	-
EIGER 400 05-07 4X4	0213-0181	-
EIGER 400 03-04 4X4-W/ 68LAC 08	0213-0181	-
EIGER 400 03-04 4X4-W/ WJ68 08	0213-0286	-
EIGER 400 02 4X4	0213-0181	-
QUAD MASTER 500 00-01 4X4	0213-0181	-
QUAD RUNNER 500 98-01 4X4	0213-0181	-
VINSON 500 06 4X4-AT	0213-0181	-
VINSON 500 03-05 4X4	0213-0286	-
VINSON 500 02 4X4-AT	0213-0181	-
KING QUAD 700 05 4X4	0213-0284	-
TWIN PEAKS 700 04-05 4X4	0213-0097	-
YAMAHA		
TIMBERWOLF 250 94-00 4X4	0213-0048	0213-0396
BIG BEAR 350 98-99 4X4	0213-0048	0213-0397
BIG BEAR 350 97 4X4-W/ 68 AC 18 INBOARD CV JOINT HAS NUMBERS STAMPED INTO THE BELL TO HELP IDENTIFY THE APPLICATION	0213-0048	0213-0396
BIG BEAR 350 97 4X4-W/ 68 LAC 18 INBOARD CV JOINT HAS NUMBERS STAMPED INTO THE BELL TO HELP IDENTIFY THE APPLICATION	0213-0048	0213-0397
BIG BEAR 350 89-96 4X4	0213-0048	0213-0396
BIG BEAR 350 87-88 4X4	0213-0272	0213-0396
BRUIN 350 04-06 4X4	0213-0099	0213-0398
GRIZZLY 350 07-08 4X4-EXC. IRS	0213-0099	0213-0398
GRIZZLY 350 07-08 4X4-W/ IRS	0213-0431	0213-0260
WOLVERINE 350 01-05 4X4	0213-0099	0213-0397
WOLVERINE 350 95-00 4X4	0213-0048	0213-0397
BIG BEAR 400 07-08 4X4-W/ IRS	0213-0431	0213-0260
BIG BEAR 400 02-06 4X4	0213-0048	0213-0398
BIG BEAR 400 00-01 4X4	0213-0048	0213-0397
GRIZZLY 400 07 4X4	0213-0099	0213-0398
KODIAK 400 00-06 4X4	0213-0099	0213-0398
KODIAK 400 99 4X4	0213-0048	0213-0397
KODIAK 400 93-98 4X4	0213-0048	0213-0396
GRIZZLY 450 08 4X4	0213-0431	0213-0260

FITS MODEL	OUTBOARD PART #	INBOARD PART #
FRONT OUTBOARD/INBOARD CV JOINT KITS (CON'T)		
YAMAHA (CON'T)		
GRIZZLY 450 07 4X4-LEFT SIDE	0213-0099	0213-0279
GRIZZLY 450 07 4X4-RIGHT SIDE	0213-0099	0213-0282
KODIAK 450 03-06 4X4-LEFT SIDE	0213-0099	0213-0279
KODIAK 450 03-06 4X4-RIGHT SIDE	0213-0099	0213-0282
WOLVERINE 450 SPORT 06 4X4	0213-0099	0213-0398
GRIZZLY 600 99-01 4X4	0213-0274	-
GRIZZLY 600 98 4X4	0213-0273	-
GRIZZLY 660 04-08 4X4-LEFT SIDE	0213-0098	0213-0280
GRIZZLY 660 04-08 4X4-RIGHT SIDE	0213-0098	0213-0260
GRIZZLY 660 03 4X4-W/ 68LAC 08-LEFT SIDE	0213-0098	0213-0280
GRIZZLY 660 03 4X4-W/ 68LAC 08-RIGHT SIDE	0213-0098	0213-0260
GRIZZLY 660 03 4X4-W/ WJ68 08-LEFT SIDE	0213-0154	0213-0280
GRIZZLY 660 03 4X4-W/ WJ68 08-RIGHT SIDE	0213-0154	0213-0260
GRIZZLY 660 02 4X4-LEFT SIDE	0213-0099	0213-0279
GRIZZLY 660 02 4X4-RIGHT SIDE	0213-0099	0213-0282
GRIZZLY 700 07-08 4X4	0213-0278	0213-0393
RHINO 450 06-07 4X4-LEFT SIDE	0213-0255	0213-0260
RHINO 450 06-07 4X4-RIGHT SIDE	0213-0255	0213-0280
RHINO 660 06-07 4X4-LEFT SIDE	0213-0255	0213-0260
RHINO 660 06-07 4X4-RIGHT SIDE	0213-0255	0213-0280
RHINO 660 05 4X4-LEFT SIDE	0213-0277	0213-0260
RHINO 660 05 4X4-RIGHT SIDE	0213-0277	0213-0280
RHINO 660 04 4X4-LEFT SIDE	0213-0254	0213-0260
RHINO 660 04 4X4-RIGHT SIDE	0213-0254	0213-0280
RHINO 700 SE 08-09 4X4	0213-0255	0213-0393

REAR OUTBOARD/INBOARD CV JOINT KITS > \$112.95-\$161.95

Heavy-duty fully assembled outboard joint and boot assembly, comes with heavy-duty puncture resistant boot, clamps and grease. Made in the USA.



FITS MODEL	OUTBOARD PART #	INBOARD PART #
REAR OUTBOARD/INBOARD CV JOINT KITS (CON'T)		
ARCTIC CAT		
250 05 2X4	0213-0179	0213-0476
250 05 4X4	0213-0179	0213-0476
250 02-04 2X4	0213-0156	0213-0476
250 02-04 4X4	0213-0156	0213-0476
250 01 2X4- INNER RACE W/ 18 TEETH	0213-0299	-
250 01 2X4- INNER RACE W/ 19 TEETH	0213-0156	0213-0476
250 01 4X4- INNER RACE W/ 18 TEETH	0213-0299	-
250 01 4X4- INNER RACE W/ 19 TEETH-	0213-0156	0213-0476
250 99-00 2X4	0213-0299	-
300 05 4X4	0213-0179	0213-0476
300 03-04 4X4	0213-0156	0213-0476
300 02 2X4	0213-0156	0213-0476
300 02 4X4	0213-0156	0213-0476
300 01 2X4- INNER RACE W/ 18 TEETH-	0213-0299	-
300 01 2X4- INNER RACE W/ 19 TEETH-	0213-0156	0213-0476
300 01 4X4- INNER RACE W/ 18 TEETH-	0213-0299	-
300 01 4X4- INNER RACE W/ 19 TEETH	0213-0156	0213-0476
300 98-00 2X4	0213-0299	-
300 98-00 4X4	0213-0299	-
400 06-08 4X4	0213-0300	0213-0482
400 05 4X4	0213-0179	0213-0482
400 02-04 2X4	0213-0156	0213-0478
400 02-04 4X4	0213-0156	0213-0478
500 06-08 4X4	0213-0300	0213-0482
500 05 4X4	0213-0179	0213-0482
500 03-04 4X4	0213-0156	0213-0478
650 06-08 4X4	0213-0300	0213-0482
650 05 4X4	0213-0179	0213-0482
650 04 4X4	0213-0179	0213-0482
700 07-08 4X4	0213-0300	0213-0482
CAN-AM		
OUTLANDER 330 04-05 ALL	0213-0308	-
OUTLANDER 400 03-08 ALL	0213-0308	-
OUTLANDER 500 07 4X4	0213-0309	-
OUTLANDER 650 06-07 4X4	0213-0309	-
OUTLANDER 800 06-07 4X4	0213-0309	-
RENEGADE 800 06-07 4X4	0213-0309	-

CONTINUED ON NEXT PAGE

FITS MODEL	OUTBOARD PART #	INBOARD PART #
REAR OUTBOARD/INBOARD CV JOINT KITS (CON'T)		
HONDA		
TRX650 RINCON 03-05 4X4	0213-0283	-
TRX680 RINCON 06-10 4X4	0213-0283	-
KAWASAKI		
BRUTE FORCE 650I 09 4X4	0213-0373	0213-0487
BRUTE FORCE 650I 06-08 4X4	0213-0303	0213-0405
BRUTE FORCE 750I 08-10 4X4	0213-0373	0213-0487
BRUTE FORCE 750I 05-07 4X4	0213-0303	0213-0405
TERYX 750 08-09 4X4-LEFT SIDE	0213-0375	0213-0489
TERYX 750 08-09 4X4-RIGHT SIDE	0213-0375	0213-0490
POLARIS		
SPORTSMAN 300 08-10 4X4	0213-0294	0213-0470
HAWKEYE 300 06-10 2X4	0213-0294	0213-0470
HAWKEYE 300 06-07 4X4	0213-0294	0213-0470
SPORTSMAN 335 00 4X4-SOME APPLICATIONS USE U-JOINTS	0213-0051	0213-0184
SPORTSMAN 400 08-10 4X4	0213-0294	0213-0470
SPORTSMAN 400 03-05 4X4	0213-0053	0213-0184
SPORTSMAN 400 01-02 4X4	0213-0051	0213-0184
SPORTSMAN 450 06-07 4X4	0213-0293	0213-0184
SPORTSMAN 500 08-10 4X4-EXC. TOURING	0213-0436	0213-0453
SPORTSMAN 500 08-10 4X4-TOURING-(REAR AXLES)	0213-0436	0213-0448
SPORTSMAN 500 06-07 4X4	0213-0293	0213-0184
SPORTSMAN 500 03-05 4X4	0213-0053	0213-0184
SPORTSMAN 500 99-02 4X4	0213-0051	0213-0184
SPORTSMAN X2 500 08-09 4X4	0213-0436	0213-0448
SPORTSMAN X2 500 06-07 4X4	0213-0293	0213-0298
OUTLAW 500 06-07 2X4-IRS	0213-0295	-
OUTLAW 525 07-09 2X4-IRS	0213-0295	-
SPORTSMAN X2 550 10 4X4	0213-0439	0213-0450
SPORTSMAN XP 550 10 4X4-EPS	0213-0439	0213-0450
SPORTSMAN XP 550 10 4X4-EXC. EPS	0213-0437	0213-0448
SPORTSMAN XP 550 09 4X4	0213-0437	0213-0448
DIESEL 00-02 4X4	0213-0051	0213-0184
SPORTSMAN 600 03-05 4X4	0213-0053	0213-0184
SPORTSMAN 700 06-07 4X4	0213-0293	0213-0184
SPORTSMAN 700 03-05 4X4	0213-0053	0213-0184
SPORTSMAN 700 02 4X4	0213-0290	0213-0184
SPORTSMAN 800 10 4X4	0213-0436	0213-0453
SPORTSMAN 800 08-09 4X4-EXC. TOURING	0213-0436	0213-0453
SPORTSMAN 800 08-09 4X4-TOURING	0213-0436	0213-0448
SPORTSMAN 800 06-07 4X4	0213-0293	0213-0184
SPORTSMAN 800 05 4X4	0213-0053	0213-0184
SPORTSMAN X2 800 08-09 4X4	0213-0436	0213-0448
SPORTSMAN X2 800 07 4X4	0213-0293	0213-0298
SPORTSMAN XP 850 10 4X4-EXC. TOURING	0213-0437	0213-0448
SPORTSMAN XP 850 10 4X4-TOURING	0213-0439	0213-0450
SPORTSMAN XP 850 09 4X4	0213-0437	0213-0448
RANGER 400 10 4X4	0213-0440	0213-0454
RANGER 500 10 4X4	0213-0438	0213-0455
RANGER 500 09 2X4-LEFT SIDE	0213-0438	0213-0451
RANGER 500 09 2X4-RIGHT SIDE	0213-0438	0213-0452
RANGER 500 09 4X4-LEFT SIDE	0213-0438	0213-0451
RANGER 500 09 4X4-RIGHT SIDE	0213-0438	0213-0452
RANGER 500 08 2X4-LEFT SIDE	0213-0436	0213-0456
RANGER 500 08 2X4-RIGHT SIDE	0213-0436	0213-0475
RANGER 500 08 4X4-LEFT SIDE	0213-0436	0213-0456
RANGER 500 08 4X4-RIGHT SIDE	0213-0436	0213-0475
RANGER 500 07 2X4-LEFT SIDE	0213-0053	0213-0400
RANGER 500 07 2X4-RIGHT SIDE	0213-0053	0213-0401
RANGER 500 07 4X4-AFTER 8/26/06-LEFT SIDE	0213-0293	0213-0400
RANGER 500 07 4X4-AFTER 8/26/06-RIGHT SIDE	0213-0293	0213-0401
RANGER 500 07 4X4-BEFORE 8/26/06-LEFT SIDE	0213-0053	0213-0400
RANGER 500 07 4X4-BEFORE 8/26/06-RIGHT SIDE	0213-0053	0213-0401
RANGER 500 05-06 2X4-LEFT SIDE	0213-0053	0213-0400
RANGER 500 05-06 2X4-RIGHT SIDE	0213-0053	0213-0401
RANGER 500 05-06 4X4-LEFT SIDE	0213-0053	0213-0400
RANGER 500 05-06 4X4-RIGHT SIDE	0213-0053	0213-0401
RANGER 700 09 4X4-LEFT SIDE	0213-0438	0213-0451
RANGER 700 09 4X4-RIGHT SIDE	0213-0438	0213-0452
RANGER 700 08 4X4-LEFT SIDE	0213-0436	0213-0456
RANGER 700 08 4X4-RIGHT SIDE	0213-0436	0213-0475
RANGER 800 10 4X4	0213-0438	0213-0455
RANGER 800 10 6X6-LEFT SIDE	0213-0438	0213-0451
RANGER 800 10 6X6-RIGHT SIDE	0213-0438	0213-0452
RANGER XP 700 09 4X4-LEFT SIDE	0213-0438	0213-0451
RANGER XP 700 09 4X4-RIGHT SIDE	0213-0438	0213-0452

FITS MODEL	OUTBOARD PART #	INBOARD PART #
REAR OUTBOARD/INBOARD CV JOINT KITS (CON'T)		
POLARIS (CON'T)		
RANGER XP 700 08 4X4-LEFT SIDE	0213-0436	0213-0456
RANGER XP 700 08 4X4-RIGHT SIDE	0213-0436	0213-0475
RANGER XP 700 07 4X4-AFTER 8/26/06-LEFT SIDE	0213-0293	0213-0400
RANGER XP 700 07 4X4-AFTER 8/26/06-RIGHT SIDE	0213-0293	0213-0401
RANGER XP 700 07 4X4-BEFORE 8/26/06-LEFT SIDE	0213-0053	0213-0400
RANGER XP 700 07 4X4-BEFORE 8/26/06-RIGHT SIDE	0213-0053	0213-0401
RANGER XP 700 05-06 4X4-LEFT SIDE	0213-0053	0213-0400
RANGER XP 700 05-06 4X4-RIGHT SIDE	0213-0053	0213-0401
RZR 08-10 4X4	0213-0297	0213-0403
RZR S "SPORT" 09-10 4X4	0213-0438	0213-0449
SUZUKI		
KING QUAD 700 05 4X4	0213-0285	-
YAMAHA		
GRIZZLY 350 07-08 4X4-W/ IRS	0213-0276	0213-0395
BIG BEAR 400 07-08 4X4-W/ IRS	0213-0276	0213-0395
GRIZZLY 400 07 4X4	0213-0276	0213-0395
KODIAK 400 05-06 4X4	0213-0276	0213-0395
KODIAK 450 05-06 4X4	0213-0276	0213-0395
GRIZZLY 450 07-08 4X4	0213-0276	0213-0395
GRIZZLY 660 04-08 4X4-LEFT SIDE	0213-0098	0213-0182
GRIZZLY 660 04-08 4X4-RIGHT SIDE	0213-0098	0213-0185
GRIZZLY 660 03 4X4-LEFT SIDE	0213-0154	0213-0182
GRIZZLY 660 03 4X4-RIGHT SIDE	0213-0154	0213-0185
GRIZZLY 660 02 4X4-LEFT SIDE	0213-0275	0213-0281
GRIZZLY 660 02 4X4-RIGHT SIDE	0213-0275	0213-0261
GRIZZLY 700 07-08 4X4	0213-0278	0213-0394
RHINO 450 06 4X4-LEFT SIDE	0213-0255	0213-0261
RHINO 450 06 4X4-RIGHT SIDE	0213-0255	0213-0281
RHINO 660 07 4X4-LEFT SIDE	0213-0255	-
RHINO 660 07 4X4-RIGHT SIDE	0213-0255	-
RHINO 660 06 4X4-LEFT SIDE	0213-0255	0213-0261
RHINO 660 06 4X4-RIGHT SIDE	0213-0255	0213-0281
RHINO 660 05 4X4-LEFT SIDE	0213-0277	0213-0261
RHINO 660 05 4X4-RIGHT SIDE	0213-0277	0213-0281
RHINO 660 04 4X4-LEFT SIDE	0213-0254	0213-0185
RHINO 660 04 4X4-RIGHT SIDE	0213-0254	0213-0182
RHINO 700 SE 08-09 4X4-LEFT SIDE	0213-0255	-
RHINO 700 SE 08-09 4X4-RIGHT SIDE	0213-0255	-



PLOWS
WINCHES
UTV
RACKS
LUGGAGE
BODY
CONTROLS
ELECTRICAL
WHEELS & TIRES
SUSPENSION & DRIVE
ENGINE
NRA BY MOOSE
RIDER
TOWING
GARAGE
PROMO



CV BOOT KITS > \$14.95

Replace those dangerously worn, inexpensive CV boots before dirt, dust and grime destroy expensive CV joints. Tougher than stock and complete with everything you need to complete the job. Heavy-duty puncture resistant boot. Comes with grease and clamps. Each complete assembly fits one side. Sold each. Made in the USA.

FITS MODEL	OUTBOARD PART #	INBOARD PART #
CV BOOT KITS		
ARCTIC CAT		
250 (FRONT AXLES) 01-05 4X4	0213-0159	0213-0044
250 (REAR AXLES) 99-00 2X4	0213-0159	0213-0044
250 (REAR AXLES) 01-05 2X4	0213-0159	0213-0044
250 (REAR AXLES) 01-05 4X4	0213-0159	0213-0044
300 (FRONT AXLES) 98-08 4X4	0213-0159	0213-0044
300 (REAR AXLES) 98-02 2X4	0213-0159	0213-0044
300 (REAR AXLES) 98-02 4X4	0213-0159	0213-0044
300 (REAR AXLES) 03-05 4X4	0213-0159	0213-0044
375 02 4X4-(FRONT AXLES)	0213-0159	0213-0044
400 (FRONT AXLES) 98-08 4X4	0213-0159	0213-0044
400 (REAR AXLES) 03-05 2X4	0213-0159	0213-0044
400 (REAR AXLES) 03-05 4X4	0213-0159	0213-0044
400 (REAR AXLES) 06-08 4X4	0213-0159	0213-0044
454 96-97 4X4-(FRONT AXLES)	0213-0039	0213-0044
454 98 4X4-BELOW SERIAL #13000	0213-0039	0213-0044
454 98 4X4-FROM SERIAL #13000	0213-0159	0213-0044
500 (FRONT AXLES) 98-08 4X4	0213-0159	0213-0044
500 (REAR AXLES) 03-08 4X4	0213-0159	0213-0044
650 (FRONT AXLES) 04-08 4X4	0213-0159	0213-0044
650 (REAR AXLES) 04-08 4X4	0213-0159	0213-0044
700 (FRONT AXLES) 07-08 4X4	0213-0159	0213-0044
700 (REAR AXLES) 07-08 4X4	0213-0159	0213-0044
CAN-AM		
OUTLANDER 330 (FRONT AXLES) 04-05 4X4	0213-0321	0213-0412
OUTLANDER 330 (REAR AXLES) 04-05 ALL	0213-0413	0213-0414
OUTLANDER 400 (FRONT AXLES) 03-05 4X4	0213-0321	0213-0412
OUTLANDER 400 (FRONT AXLES) 06-08 4X4	0213-0322	0213-0323
OUTLANDER 400 (REAR AXLES) 03-08 ALL	0213-0413	0213-0414
OUTLANDER 500 (FRONT AXLES) 07-08 4X4	0213-0322	0213-0323
OUTLANDER 500 (REAR AXLES) 07 4X4	0213-0324	0213-0324
QUEST 500 02-04 4X4-(FRONT AXLES)	0213-0321	0213-0412
RENEGADE 500 (FRONT AXLES) 08 4X4	0213-0322	0213-0323
TRAXTER 500 99-05 4X4-(FRONT AXLES)	0213-0321	0213-0412
OUTLANDER 650 (FRONT AXLES) 06-08 4X4	0213-0322	0213-0323
OUTLANDER 650 (REAR AXLES) 06-07 4X4	0213-0324	0213-0324
QUEST 650 02-04 4X4-(FRONT AXLES)	0213-0321	0213-0412
OUTLANDER 800 (FRONT AXLES) 06-08 4X4	0213-0322	0213-0323
OUTLANDER 800 (REAR AXLES) 06-07 4X4	0213-0324	0213-0324
RENEGADE 800 (FRONT AXLES) 07-08 4X4	0213-0322	0213-0323
RENEGADE 800 (REAR AXLES) 07 4X4	0213-0324	0213-0324
HONDA		
TRX300 FOURTRAX 88-00 4X4	0213-0039	0213-0041
TRX350 RANCHER 86-89 4X4	0213-0039	-
TRX350 RANCHER 00-03 4X4	0213-0039	0213-0042
TRX400 FOREMAN 95-01 4X4	0213-0039	0213-0041
TRX400 FOREMAN 03 4X4	0213-0039	0213-0042
TRX420 RANCHER ES 07-08 4X4	0213-0039	0213-0311
TRX450 FOREMAN 98-04 4X4	0213-0039	0213-0042
TRX500 FOREMAN 07 4X4-ES W/ POWER STEERING	0213-0039	0213-0311
TRX500 FOREMAN 07 4X4-EXC. ES W/ POWER STEERING	0213-0157	0213-0311
TRX500 FOREMAN 08 4X4	0213-0039	0213-0311
TRX500 RUBICON 01-04 4X4	0213-0157	0213-0042
TRX500 RUBICON 05-07 4X4	0213-0157	0213-0311
TRX500 RUBICON 08 4X4	0213-0039	0213-0311
TRX650 RINCON (FRONT AXLES) 03-04 4X4	0213-0157	0213-0042
TRX650 RINCON (FRONT AXLES) 05 4X4	0213-0157	0213-0311
TRX650 RINCON (REAR AXLES) 03-05 4X4	0213-0158	0213-0251
TRX680 RINCON (FRONT AXLES) 06-07 4X4	0213-0157	0213-0311
TRX680 RINCON (FRONT AXLES) 08 4X4	0213-0039	0213-0311
TRX680 RINCON (REAR AXLES) 06-08 4X4	0213-0158	0213-0251
KAWASAKI		
BAYOU 300 89-04 4X4	0213-0039	0213-0042
PRAIRIE 300 99-02 4X4	0213-0039	0213-0041
PRAIRIE 360 03-05 4X4	0213-0039	0213-0041

FITS MODEL	OUTBOARD PART #	INBOARD PART #
CV BOOT KITS (CON'T)		
KAWASAKI (CON'T)		
PRAIRIE 360 06-08 4X4	0213-0039	0213-0160
PRAIRIE 360 09-10 4X4	0213-0411	-
BAYOU 400 93-99 4X4	0213-0039	0213-0042
PRAIRIE 400 97-02 4X4	0213-0039	0213-0041
BRUTE FORCE 650 04-08 4X4	0213-0039	0213-0160
BRUTE FORCE 650I (FRONT AXLES) 06-08 4X4	0213-0252	0213-0160
BRUTE FORCE 650I (REAR AXLES) 06-08 4X4	0213-0252	0213-0319
BRUTE FORCE 650I (FRONT AXLES) 09 4X4	0213-0408	-
BRUTE FORCE 650I (REAR AXLES) 09 4X4	0213-0407	-
BRUTE FORCE 650 10 4X4	0213-0411	-
PRAIRIE 650 02-03 4X4	0213-0039	0213-0041
PRAIRIE 700 04-06 4X4	0213-0039	0213-0160
BRUTE FORCE 750I (FRONT AXLES) 05-07 4X4	0213-0252	0213-0160
BRUTE FORCE 750I (REAR AXLES) 05-07 4X4	0213-0252	0213-0319
BRUTE FORCE 750I (FRONT AXLES) 08-10 4X4	0213-0408	0213-0409
BRUTE FORCE 750I (REAR AXLES) 08-10 4X4	0213-0407	-
MULE 610 05-07 4WD-400CC	0213-0252	0213-0041
MULE 610 10 4WD-400CC	0213-0408	-
MULE 2010 90 4WD-540CC	0213-0039	-
MULE 2510 93-99 4WD-620CC	0213-0039	-
MULE 2510 00-02 4WD-620CC & 950CC DIESEL	0213-0039	0213-0042
MULE 3010 01-08 4WD-620CC & 950CC DIESEL	0213-0039	0213-0042
MULE 4010 09-10 4WD- 620CC & 950CC DIESEL	0213-0411	-
TERYX 750 (FRONT AXLES) 09 4X4-FROM SERIAL #98500713	0213-0407	-
TERYX 750 (REAR AXLES) 08-09 4X4	-	0213-0410
TERYX 750 (REAR AXLES) 08-09 4X4	0213-0430	-
KYMCO		
MXU 500 06-07 4X4	0213-0039	0213-0041
POLARIS		
250 93 4X4	0213-0100	-
250 93 6X6	0213-0100	-
BIG BOSS 250 91 6X6	0213-0040	-
BIG BOSS 250 92 6X6-W/ BTB 08	0213-0040	-
BIG BOSS 250 92 6X6-W/ USA 08	0213-0100	-
TRAIL BOSS 250 91 4X4	0213-0040	-
TRAIL BOSS 250 92 4X4-W/ BTB 08	0213-0040	-
TRAIL BOSS 250 92 4X4-W/ USA 08	0213-0100	-
XPLORER 250 00-02 4X4	0213-0100	-
300 94 4X4	0213-0100	-
300 94 6X6	0213-0100	-
300 95 4X4	0213-0040	-
300 96 4X4	0213-0100	-
HAWKEYE 300 (FRONT AXLES) 06-07 4X4	0213-0039	0213-0041
HAWKEYE 300 (REAR AXLES) 06-07 2X4	0213-0039	0213-0041
HAWKEYE 300 (REAR AXLES) 06-07 4X4	0213-0039	0213-0041
XPLORER 300 96-99 4X4	0213-0040	-
MAGNUM 325 00 4X4	0213-0040	-
MAGNUM 325 01-02 4X4-EXC. HDS (VISCO-LOK)	0213-0040	-
MAGNUM 325 01-02 4X4-HDS (VISCO-LOK)	0213-0040	0213-0315
XPEDITION 325 00-02 4X4	0213-0040	-
ATP 330 04 4X4	0213-0100	-
ATP 330 05 4X4	0213-0100	0213-0312
MAGNUM 330 03-04 4X4-EXC. HDS (VISCO-LOK)	0213-0100	-
MAGNUM 330 03-04 4X4-HDS (VISCO-LOK)	0213-0040	0213-0315
MAGNUM 330 05-06 4X4	0213-0100	0213-0312
SPORTSMAN 335 (FRONT AXLES) 99-00 4X4	0213-0040	-
SPORTSMAN 335 (REAR AXLES) 00 4X4 SOME MODELS USE U-JOINTS	0213-0045	0213-0043
WORKER 335 99 4X4	0213-0040	-
350L 90 4X4	0213-0040	-
350L 93 4X4	0213-0100	-
350L 93 6X6	0213-0100	-
TRAIL BOSS 350L 91 4X4	0213-0040	-
TRAIL BOSS 350L 92 4X4-W/ BTB 08	0213-0040	-
TRAIL BOSS 350L 92 4X4-W/ USA 08	0213-0100	-
400L 94 4X4	0213-0100	-
400L 94 6X6	0213-0100	-
400L 95-96 6X6-W/ BTB 08	0213-0040	-
400L 95-96 6X6-W/ USA 08	0213-0100	-
BIG BOSS 400L 97 6X6	0213-0040	-
SCRAMBLER 400 95-96 4X4-W/ BTB 08	0213-0040	-
SCRAMBLER 400 95-96 4X4-W/ USA 08	0213-0100	-
SCRAMBLER 400 97-98 4X4	0213-0040	-
SCRAMBLER 400 99 4X4-W/ BTB 08	0213-0040	-
SCRAMBLER 400 99 4X4-W/ USA 18	0213-0100	-
SCRAMBLER 400 00-02 4X4	0213-0100	-

CONTINUED ON NEXT PAGE

FITS MODEL	OUTBOARD PART #	INBOARD PART #
CV BOOT KITS (CON'T)		
POLARIS (CON'T)		
SPORTSMAN 400 (FRONT AXLES) 94 4X4	0213-0100	-
SPORTSMAN 400 (FRONT AXLES) 95-96 4X4-W/ BTB OB	0213-0040	-
SPORTSMAN 400 (FRONT AXLES) 95-96 4X4-W/ USA OB	0213-0100	-
SPORTSMAN 400 (FRONT AXLES) 97 4X4	0213-0040	-
SPORTSMAN 400 (FRONT AXLES) 01 4X4	0213-0040	-
SPORTSMAN 400 (FRONT AXLES) 02-04 4X4	0213-0100	-
SPORTSMAN 400 (FRONT AXLES) 05 4X4	0213-0100	0213-0312
SPORTSMAN 400 (REAR AXLES) 01-02 4X4	0213-0045	0213-0043
SPORTSMAN 400 (REAR AXLES) 03-05 4X4	0213-0178	0213-0043
XPLORER 400 95-96 4X4-W/ BTB OB	0213-0040	-
XPLORER 400 95-96 4X4-W/ USA OB	0213-0100	-
XPLORER 400 97-98 4X4	0213-0040	-
XPLORER 400 99-02 4X4	0213-0100	-
MAGNUM 425 95-96 4X4-W/ BTB OB	0213-0040	-
MAGNUM 425 95-96 4X4-W/ USA OB	0213-0100	-
MAGNUM 425 95-96 6X6-W/ BTB OB	0213-0040	-
MAGNUM 425 95-96 6X6-W/ USA OB	0213-0100	-
MAGNUM 425 97-98 4X4	0213-0040	-
MAGNUM 425 97-98 6X6	0213-0040	-
XPEDITION 425 00-01 4X4	0213-0040	-
XPEDITION 425 02 4X4	0213-0100	-
SPORTSMAN 450 (FRONT SHAFT) 06-07 4X4-AFTER 7/25/06	0213-0316	0213-0317
SPORTSMAN 450 (FRONT SHAFT) 06-07 4X4-BEFORE 7/25/06	0213-0040	0213-0318
SPORTSMAN 450 (REAR AXLES) 06-07 4X4	0213-0313	0213-0314
DIESEL 455 (FRONT AXLES) 99-02 4X4	0213-0040	-
DIESEL 455 (REAR AXLES) 00-02 4X4	0213-0045	0213-0043
ATP 500 H.O. 04 4X4	0213-0100	-
ATP 500 H.O. 05 4X4	0213-0100	0213-0312
ATV PRO 500 02 4X4-PPS	0213-0040	0213-0315
BIG BOSS 500 98 6X6	0213-0040	-
LUH 500 02 6X6	0213-0100	-
XPLORER 500 97 4X4	0213-0100	-
MAGNUM 500 99-00 4X4	0213-0040	-
MAGNUM 500 01 4X4-EXC. HDS (VISCO-LOK)	0213-0040	-
MAGNUM 500 02 2X4-HDS (VISCO-LOK)	0213-0100	-
MAGNUM 500 02 4X4-EXC. HDS (VISCO-LOK)	0213-0100	-
MAGNUM 500 02 4X4-HDS (VISCO-LOK)	0213-0040	0213-0315
MAGNUM 500 03 4X4	0213-0040	0213-0315
OUTLAW 500 (REAR AXLES) 06-07 2X4-IRS	0213-0100	-
SCRAMBLER 500 97-98 4X4	0213-0040	-
SCRAMBLER 500 99-07 4X4	0213-0100	-
SPORTSMAN 500 (FRONT AXLES) 96 4X4-W/ BTB OB	0213-0040	-
SPORTSMAN 500 (FRONT AXLES) 96 4X4-W/ USA OB	0213-0100	-
SPORTSMAN 500 (FRONT AXLES) 97 4X4	0213-0100	-
SPORTSMAN 500 (FRONT AXLES) 98-99 4X4	0213-0040	-
SPORTSMAN 500 (FRONT AXLES) 00-01 4X4	0213-0040	-
SPORTSMAN 500 (FRONT AXLES) 00-01 6X6	0213-0040	-
SPORTSMAN 500 (FRONT AXLES) 02-04 4X4	0213-0100	-
SPORTSMAN 500 (FRONT AXLES) 02-04 6X6	0213-0100	-
SPORTSMAN 500 (FRONT AXLES) 05 4X4	0213-0100	0213-0312
SPORTSMAN 500 (FRONT AXLES) 05 6X6	0213-0100	-
SPORTSMAN 500 (FRONT AXLES) 06 4X4	0213-0040	0213-0318
SPORTSMAN 500 (FRONT AXLES) 06 6X6	0213-0100	-
SPORTSMAN 500 (FRONT AXLES) 07 4X4-AFTER 7/25/06	0213-0316	0213-0317
SPORTSMAN 500 (FRONT AXLES) 07 4X4-BEFORE 7/25/06	0213-0040	0213-0318
SPORTSMAN 500 (FRONT AXLES) 07 6X6	0213-0100	-
SPORTSMAN 500 (REAR AXLES) 99-02 4X4	0213-0045	0213-0043
SPORTSMAN 500 (REAR AXLES) 03-05 4X4	0213-0178	0213-0043
SPORTSMAN 500 (REAR AXLES) 06-07 4X4	0213-0313	0213-0314
SPORTSMAN 500 (REAR AXLES) 08-10 4X4	0213-0426	0213-0429
SPORTSMAN X2 500 (FRONT AXLES) 07 4X4-AFTER 7/25/06	0213-0316	0213-0317
SPORTSMAN X2 500 (FRONT AXLES) 07 4X4-BEFORE 7/25/06	0213-0040	0213-0318
SPORTSMAN X2 500 (REAR AXLES) 07 4X4	0213-0313	0213-0314
SPORTSMAN X2 500 (REAR AXLES) 08-10 4X4	0213-0426	0213-0429
OUTLAW 525 (REAR AXLES) 07 2X4-IRS	0213-0100	-
SPORTSMAN XP 550 (REAR AXLES) 09 4X4	0213-0426	0213-0429
SPORTSMAN XP 550 (REAR AXLES) 10 4X4-EXC. EPS	0213-0426	0213-0429
SPORTSMAN X2 550 (REAR AXLES) 10 4X4	0213-0464	0213-0465
SPORTSMAN XP 550 (REAR AXLES) 10 4X4-EPS W/ ELECTRONIC POWER STEERING	0213-0464	0213-0465
SPORTSMAN X2 800 (FRONT AXLES) 07 4X4-AFTER 7/25/06	0213-0316	0213-0317
SPORTSMAN X2 800 (FRONT AXLES) 07 4X4-BEFORE 7/25/06	0213-0040	0213-0318
SPORTSMAN X2 800 (REAR AXLES) 07 4X4	0213-0313	0213-0314
SPORTSMAN 600 (FRONT AXLES) 03-04 4X4	0213-0100	-
SPORTSMAN 600 (FRONT AXLES) 05 4X4	0213-0100	0213-0312

FITS MODEL	OUTBOARD PART #	INBOARD PART #
CV BOOT KITS (CON'T)		
POLARIS (CON'T)		
SPORTSMAN 600 (REAR AXLES) 03-05 4X4	0213-0178	0213-0043
SPORTSMAN 700 (FRONT AXLES) 02-04 4X4	0213-0100	-
SPORTSMAN 700 (FRONT AXLES) 05 4X4	0213-0100	0213-0312
SPORTSMAN 700 (FRONT AXLES) 06-07 4X4-AFTER 7/25/06	0213-0316	0213-0317
SPORTSMAN 700 (FRONT AXLES) 06-07 4X4-BEFORE 7/25/06	0213-0040	0213-0318
SPORTSMAN 700 (REAR AXLES) 02-05 4X4	0213-0178	0213-0043
SPORTSMAN 700 (REAR AXLES) 06-07 4X4	0213-0313	0213-0314
SPORTSMAN 800 (FRONT AXLES) 05 4X4	0213-0100	0213-0312
SPORTSMAN 800 (FRONT AXLES) 06 4X4		
OB HOUSING STAMPED *BKN*	0213-0040	0213-0318
SPORTSMAN 800 (FRONT AXLES) 06 4X4		
OB HOUSING STAMPED *NEAPCO*	0213-0100	0213-0312
SPORTSMAN 800 (FRONT AXLES) 07 4X4-AFTER 7/25/06	0213-0316	0213-0317
SPORTSMAN 800 (FRONT AXLES) 07 4X4-BEFORE 7/25/06	0213-0040	0213-0318
SPORTSMAN 800 (REAR AXLES) 05 4X4	0213-0178	0213-0314
SPORTSMAN 800 (REAR AXLES) 06-07 4X4	0213-0313	0213-0314
SPORTSMAN 800 (REAR AXLES) 08-10 4X4	0213-0426	0213-0429
SPORTSMAN X2 800 (REAR AXLES) 08-10 4X4	0213-0426	0213-0429
SPORTSMAN XP 850 (REAR AXLES) 09-10 4X4	0213-0426	0213-0429
SPORTSMAN 850 (REAR AXLES) 10 4X4	0213-0464	0213-0465
RANGER 400 (FRONT AXLES) 10 4X4	0213-0406	-
RANGER 500 (FRONT AXLES) 04-05 4X4	0213-0040	0213-0318
RANGER 500 (FRONT AXLES) 04-05 6X6	0213-0100	-
RANGER 500 (FRONT AXLES) 06-07 4X4	0213-0100	0213-0312
RANGER 500 (FRONT AXLES) 08 4X4	0213-0406	-
RANGER 500 (REAR AXLES) 05-07 2X4	0213-0313	0213-0314
RANGER 500 (REAR AXLES) 05-07 4X4	0213-0313	0213-0314
RANGER 500 (REAR AXLES) 08-10 2X4	0213-0426	0213-0429
RANGER 500 (REAR AXLES) 08-10 4X4	0213-0426	0213-0429
RANGER 700 (FRONT AXLES) 06-07 6X6	0213-0100	0213-0312
RANGER 700 (MIDDLE AXLES) 06 6X6	0213-0313	0213-0314
RANGER XP 700 (FRONT AXLES) 05 4X4	0213-0040	0213-0318
RANGER XP 700 (FRONT AXLES) 06-07 4X4	0213-0100	0213-0312
RANGER XP 700 (REAR AXLES) 05-07 4X4	0213-0313	0213-0314
RANGER 700 (FRONT AXLES) 08-09 4X4	0213-0406	-
RANGER 700 (FRONT AXLES) 08-09 6X6	0213-0406	-
RANGER 700 (MIDDLE AXLES) 08-09 6X6	0213-0426	0213-0429
RANGER 700 (REAR AXLES) 08-09 4X4	0213-0426	0213-0429
RANGER XP 700 (FRONT AXLES) 08 4X4	0213-0406	-
RANGER XP 700 (REAR AXLES) 08-09 4X4	0213-0426	0213-0429
RANGER 800 (FRONT AXLES) 10 4X4	0213-0426	0213-0429
RANGER 800 (MIDDLE AXLES) 10 6X6	0213-0426	0213-0429
RANGER 800 (REAR AXLES) 10 6X6	0213-0426	0213-0429
RANGER 800 (MIDDLE AXLES) 11-13 6X6	0213-0558	-
RANGER 800 (REAR AXLES) 11-13 6X6	0213-0558	-
RANGER 800 (REAR AXLES) 11-13 4X4	0213-0558	-
RANGER 99-01 4X4-SERIES 99	0213-0100	-
RANGER 02 4X4-SERIES 10	0213-0100	-
RANGER 03-04 4X4-SERIES 11	0213-0100	-
RZR 800 (FRONT AXLES) 08 4X4	-	0213-0312
RZR 800 (REAR AXLES) 08 4X4	0213-0316	0213-0463
RZR 800 (REAR AXLES) 11-13 4X4	0213-0558	-
RZR (FRONT AXLES) 08-10 4X4	0213-0406	-
RZR S "SPORT" (FRONT AXLES) 09-10 4X4	0213-0406	-
RZR S "SPORT" (REAR AXLES) 09-10 4X4	0213-0426	0213-0429
RZR (REAR AXLES) 08-10 4X4	-	0213-0463
RZR 900 (FRONT AXLES) 11-13 4X4	0213-0558	-
RZR 900 (REAR AXLES) 11-13 4X4	0213-0558	-
SUZUKI		
QUAD RUNNER 250 87 4X4	0213-0041	-
QUAD RUNNER 250 88-96 4X4	0213-0039	0213-0251
QUAD RUNNER 250 97-98 4X4-W/ 68LAC IB	0213-0039	0213-0041
QUAD RUNNER 250 97-98 4X4-W/ 71LAC IB	0213-0039	0213-0251
QUAD RUNNER 250 99-02 4X4	0213-0039	0213-0041
KING QUAD 300 91-93 4X4	0213-0039	0213-0251
KING QUAD 300 96-98 4X4-W/ 68LAC IB	0213-0039	0213-0041
KING QUAD 300 96-98 4X4-W/ 71LAC IB	0213-0039	0213-0251
KING QUAD 300 99-02 4X4	0213-0039	0213-0041
QUAD RUNNER 300 94-95 4X4	0213-0039	0213-0251
EIGER 400 02 4X4	0213-0039	0213-0041
EIGER 400 03-04 4X4-W/ 68LAC OB	0213-0039	0213-0041
EIGER 400 03-04 4X4-W/ UJ68 OB	0213-0310	0213-0250
EIGER 400 05-07 4X4	0213-0039	0213-0160
QUAD MASTER 500 00-01 4X4	0213-0039	0213-0041
QUAD RUNNER 500 98-01 4X4	0213-0039	0213-0041

CONTINUED ON NEXT PAGE

PLOWS
WINCHES
UTV
RACKS
LUGGAGE
BODY
CONTROLS
ELECTRICAL
WHEELS & TIRES
SUSPENSION & DRIVE
ENGINE
NRA BY MODEL
RIDER
TOWING
GARAGE
PROMO

FITS MODEL	OUTBOARD PART #	INBOARD PART #
CV BOOT KITS (CON'T)		
SUZUKI (CON'T)		
VINSON 500 02 4X4-AT	0213-0039	0213-0041
VINSON 500 03-05 4X4	0213-0310	0213-0250
VINSON 500 06 4X4-AT	0213-0039	0213-0160
KING QUAD 500 (REAR AXLES) 09-10 4X4	0213-0556	0213-0557
KING QUAD 500 (FRONT AXLES) 11-12 4X4-W/ POWER STEERING	-	0213-0557
KING QUAD 500 (REAR AXLES) 11-12 4X4-W/ POWER STEERING	0213-0556	0213-0557
Q.U.V. 620 05 4X4	0213-0039	0213-0042
KING QUAD 700 (FRONT AXLES) 05 4X4	0213-0158	0213-0251
KING QUAD 700 (REAR AXLES) 05 4X4	0213-0158	0213-0251
TWIN PEAKS 700 04-05 4X4	0213-0039	0213-0160
KING QUAD 750 (REAR AXLES) 09-12 4X4-W/ POWER STEERING	0213-0556	0213-0557
KING QUAD 750 (FRONT AXLES) 09-12 4X4-W/ POWER STEERING	-	0213-0557
YAMAHA		
TIMBERWOLF 250 94-00 4X4	0213-0039	0213-0042
BIG BEAR 350 87-96 4X4	0213-0039	0213-0042
BIG BEAR 350 97 4X4-W/ 68 AC 1B	0213-0039	0213-0042
BIG BEAR 350 97 4X4-W/ 68 LAC 1B	0213-0039	0213-0041
BIG BEAR 350 98-99 4X4	0213-0039	0213-0041
BRUIN 350 04-06 4X4	0213-0039	0213-0042
GRIZZLY 350 (FRONT AXLE) 07-08 4X4-EXC. IRS	0213-0039	0213-0042
GRIZZLY 350 (FRONT AXLE) 07-08 4X4-W/ IRS	0213-0039	0213-0160
GRIZZLY 350 (REAR AXLE) 07-08 4X4-W/ IRS	0213-0039	0213-0041
WOLVERINE 350 95-05 4X4	0213-0039	0213-0041
BIG BEAR 400 (FRONT AXLES) 00-01 4X4-EXC. IRS	0213-0039	0213-0041
BIG BEAR 400 (FRONT AXLES) 02-06 4X4-EXC. IRS	0213-0039	0213-0042
BIG BEAR 400 (FRONT AXLES) 07-08 4X4-W/ IRS	0213-0039	0213-0160
BIG BEAR 400 (REAR AXLE) 07-08 4X4-W/ IRS	0213-0039	0213-0041
GRIZZLY 400 (FRONT AXLE) 07 4X4	0213-0039	0213-0042
GRIZZLY 400 (REAR AXLE) 07 4X4	0213-0039	0213-0041
KODIAK 400 (FRONT AXLE) 93-06 4X4	0213-0039	0213-0042
KODIAK 400 (REAR AXLE) 05-06 4X4	0213-0039	0213-0041
GRIZZLY 450 (FRONT AXLE) 07 4X4	0213-0039	0213-0041
GRIZZLY 450 (FRONT AXLE) 08 4X4	0213-0039	0213-0160
GRIZZLY 450 (REAR AXLE) 07-08 4X4	0213-0039	0213-0041
KODIAK 450 (FRONT AXLE) 03-06 4X4	0213-0039	0213-0041
KODIAK 450 (REAR AXLE) 05-06 4X4	0213-0039	0213-0041
RHINO 450 (FRONT AXLE) 06 4X4	0213-0252	0213-0160
RHINO 450 (REAR AXLE) 06 4X4	0213-0252	0213-0041
WOLVERINE 450 SPORT 06-08 4X4	0213-0039	0213-0042
GRIZZLY 600 98-01 4X4	0213-0039	0213-0041
GRIZZLY 660 (FRONT AXLE) 02 4X4	0213-0039	0213-0041
GRIZZLY 660 (FRONT AXLE) 03 4X4-W/ 68 LAC 0B	0213-0039	0213-0250
GRIZZLY 660 (FRONT AXLE) 03 4X4-W/ UJ 68 0B	0213-0310	0213-0250
GRIZZLY 660 (FRONT AXLE) 04-08 4X4	0213-0039	0213-0250
GRIZZLY 660 (REAR AXLE) 02 4X4	0213-0039	0213-0041
GRIZZLY 660 (REAR AXLE) 03 4X4	0213-0310	0213-0041
GRIZZLY 660 (REAR AXLE) 04-08 4X4	0213-0039	0213-0041
RHINO 660 (FRONT AXLE) 04 4X4	0213-0039	0213-0041
RHINO 660 (FRONT AXLE) 05-07 4X4	0213-0252	0213-0160
RHINO 660 (REAR AXLE) 04 4X4	0213-0039	0213-0041
RHINO 660 (REAR AXLE) 05-07 4X4	0213-0252	0213-0041
GRIZZLY 700 (FRONT AXLE) 07-08 4X4	0213-0320	0213-0042
GRIZZLY 700 (REAR AXLE) 07-08 4X4	0213-0320	0213-0042
RHINO 700 SE (FRONT AXLE) 08 4X4	0213-0252	0213-0041
RHINO 700 SE (REAR AXLE) 08 4X4	-	0213-0252
SCRAMBLER 400 97-98 4X4	0213-0040	-
GRIZZLY 700 (REAR AXLE) 07-08 4X4	0213-0320	0213-0042
RHINO 700 SE (FRONT AXLE) 08 4X4	0213-0252	0213-0041
RHINO 700 SE (REAR AXLE) 08 4X4	-	0213-0252

BOOT CLAMPS > \$1.95-\$32.95

Boot kits use the free-end style clamps that offer the advantage of allowing the installer to apply the desired amount of torque. Made in the USA.

DESCRIPTION	PART #
5MM X 254MM (EACH)	M92-06802
5MM X 254MM (25 PIECES)	M92-06803
6MM X 482MM (EACH)	M92-06804
6MM X 482MM (25 PIECES)	M92-06805
REPLACEMENT CLAMPS (SET OF 4)	M92-06806



FAST BOOT II > \$2.95-\$17.95

ATV CV boot that fits virtually all ATV's. Made from the finest neoprene rubber available. One fast boot provides the coverage for front or rear axles and inner or outer joints. Made in the USA.

DESCRIPTION	PART #
FAST BOOT KIT	0213-0427
CV BOOT GREASE	3607-0010
6 PK BOOTS	0213-0428



SPANNER TOOL > \$12.95

Eases the job of suspension adjustment. Made in the USA.

DESCRIPTION	PART #
SPANNER TOOL	3805-0057



3811-0038



M92-06811



M92-06812

QUICK-SHOT CV BOOT INSTALLATION KIT > \$227.95

The Fast Boot/Quick Shot combination provides the fastest, cleanest and most effortless method possible to replace CV boot on any major brand ATV or UTV. The tool utilizes air pressure to expand the CV boot for "over the joint" installations. Use only Fast Boots with your Quick Shot. OEM and other aftermarket boots may cause the steel legs of the tool to bend or CV boot may be torn. Made in the USA.

FAST BOOT PREMIUM TOOL > \$55.95

High strength construction and a convenient ratchet provides the tension needed for properly securing the fast boot clamps. Made in the USA.

FAST BOOT STANDARD TOOL > \$18.95

Standard banding tool. Features a tensioning nut and lever action to provide a simple, yet effective method for installing fast boot clamps. Works with 1/2" socket. Made in the USA.

DESCRIPTION	PART #
QUICK SHOT	3811-0038
FAST BOOT TOOL (PREMIUM)	M92-06811
FAST BOOT TOOL (STANDARD)	M92-06812

FRONT WHEEL CYLINDER REPAIR KITS > \$25.95-\$40.95

Rebuild kits for the wheel cylinders of front hydraulic drum brakes. Each kit includes all necessary parts for one side brake system. Imported.



FITS MODEL	PART #	FITS MODEL	PART #
HONDA		KAWASAKI	
TRX200 FOURTRAX 90-96	1702-0002	KLF300 BAYOU 86-87	1702-0006
TRX300 FOURTRAX 88-98	1702-0002	SUZUKI	
TRX300FW FOURTRAX 88-98	1702-0002	LTF4WD QUADRUNNER 97-98	1702-0007
TRX250 FOURTRAX 85-87	1702-0003	LTF250 QUADRUNNER 88-98	1702-0007
TRX300FW FOURTRAX 92-98	1702-0004	LTF4WD QUADRUNNER 87-98	1702-0007
TRX350/D FOURTRAX 86-89	1702-0005	LTF4WDX KING QUAD 96-98	1702-0007
TRX350 04-06	1702-0087	YAMAHA	
TRX400FW FOREMAN 95-98	1702-0004	YFM350U BIG BEAR 96-98	1702-0008
TRX400FA/FGA 04-07	1702-0087	YFM350F/FW BIG BEAR 87-98	1702-0008
TRX400FW 99-03	1702-0087	YFM400F/FW KODIAK 93-98	1702-0008
TRX450ES/S 98-04	1702-0087		
TRX500FA/FGA 01-04	1702-0087		
TRX650FA 03-05	1702-0087		



ALUMINUM WHEEL SPACERS > \$115.95-\$181.95

Increase wheel stability by moving wheels out 1" & 1.5". Eliminates rubbing against shocks, struts and exhaust. Imported.

FITS MODEL	POSITION	LUG SIZE	OFFSET 1" PART #	OFFSET 1.5" PART #
ALUMINUM WHEEL SPACERS				
ARCTIC CAT				
300I/400I/450I/500I/650I/700I/1000 2X4/ 4X4 02-10	FRONT/REAR	4/115	MUD6513	0222-0266
TRV400/500/550/650/700/1000 4X4 06-11	FRONT/REAR	4/115	MUD6513	0222-0266
MUDPRO 650HI/700HI/1000HI 10	FRONT/REAR	4/115	MUD6513	0222-0266
PROWLER 650 06-11	FRONT/REAR	4/115	MUD6513	0222-0266
THUNDERCAT 1000 H2 SE 09-10	FRONT/REAR	4/115	MUD6513	0222-0266
CAN-AM				
OUTLANDER 330/400/450/500/650/800 03-11	FRONT/REAR	4/137	0222-0136	-
TRAXTER 500 4X4 99-06	FRONT/REAR	4/110	MUD6512	0222-0264
RENEGADE 500/800 07-11	FRONT/REAR	4/137	0222-0136	-
QUEST 650 01-06	FRONT/REAR	4/110	MUD6512	0222-0264
COMMANDER 800/1000 11	FRONT/REAR	4/137	0222-0136	-
HONDA				
TRX300 4X4 89-00	FRONT/REAR	4/110	MUD6512	0222-0264
TRX350 RANCHER S-ES 4X4 00-06	FRONT/REAR	4/110	MUD6512	0222-0264
TRX400/420 RANCHER 4X4 (STRAIGHT-AXLE) 04-10	FRONT/REAR	4/110	MUD6512	0222-0264
TRX400 FOREMAN 4X4 96-06	FRONT/REAR	4/110	MUD6512	0222-0264
TRX420 RANCHER AT (IRS) 09-10	FRONT/REAR	4/110	MUD6512	0222-0264
TRX450/500 FOREMAN S-ES 4X4 98-11	FRONT/REAR	4/110	MUD6512	0222-0264
TRX500 RUBICON 4X4 91-11	FRONT/REAR	4/110	MUD6512	0222-0264
TRX650/680 RINCON 4X4 02-11	FRONT/REAR	4/110	MUD6512	0222-0264
KAWASAKI				
BRUTE FORCE 650I 4X4 06-10	FRONT/REAR	4/110	MUD6512	0222-0264
BRUTE FORCE 750 4X4 05-10	FRONT/REAR	4/110	MUD6512	0222-0264
KFX700 V-FORCE 04-10	FRONT	4/144	0222-0295	-
POLARIS				
SPORTSMAN 335 99-06	FRONT/REAR	4/156	0222-0137	0222-0265
SPORTSMAN 400/450 95-11	FRONT/REAR	4/156	0222-0137	0222-0265
SPORTSMAN 500 96-11	FRONT/REAR	4/156	0222-0137	0222-0265
SPORTSMAN 550/850 XP (10MM METRIC STUDS) 08-10	FRONT/REAR	4/156	0222-0268	-
MAGNUM 500 02-06	FRONT/REAR	4/156	0222-0137	0222-0265
SPORTSMAN 600 03-09	FRONT/REAR	4/156	0222-0137	0222-0265
SPORTSMAN 700 02-09	FRONT/REAR	4/156	0222-0137	0222-0265
SPORTSMAN 800 05-11	FRONT/REAR	4/156	0222-0137	0222-0265
SUZUKI				
EIGER 400 4X4 02-07	FRONT/REAR	4/110	MUD6512	0222-0264
KING QUAD 400 4X4 (STRAIGHT-AXLE) 08-10	FRONT/REAR	4/110	MUD6512	0222-0264
KING QUAD 450/500/700/750 05-11	FRONT/REAR	4/110	MUD6512	0222-0264
VINSON 500 4X4 02-09	FRONT/REAR	4/110	MUD6512	0222-0264
YAMAHA				
BRUIN 350 2X4/4X4 (STRAIGHT-AXLE) 04-09	FRONT/REAR	4/110	MUD6512	0222-0264
BIG BEAR 350/400 2X4/4X4 87-06	FRONT/REAR	4/110	MUD6512	0222-0264
WOLVERINE 350/450 4X4 95-10	FRONT/REAR	4/110	MUD6512	0222-0264
KODIAK 400/450 4X4 93-04	FRONT/REAR	4/110	MUD6512	0222-0264
GRIZZLY 350/450/550/600/700 4X4 98-11	FRONT/REAR	4/110	MUD6512	0222-0264
KODIAK 350 (IRS) 07-09	FRONT/REAR	4/110	MUD6512	0222-0264
BIG BEAR 400 (IRS) 07-11	FRONT/REAR	4/110	MUD6512	0222-0264
KODIAK 400/450/550 (IRS) 4X4 05-09	FRONT/REAR	4/110	MUD6512	0222-0264
RHINO 450/660/700 04-11	FRONT/REAR	4/110	MUD6512	0222-0264

PLOWS
WINCHES
UTV
RACKS
LUGGAGE
BODY
CONTROLS
ELECTRICAL
WHEELS & TIRES
SUSPENSION & DRIVE
ENGINE
NRA BY MODEL
RIDER
TOWING
GARAGE
PROMO



WHEEL SPACERS > \$106.95

Made from urethane elastomer with titanium and graphite for added strength. These spacers give your ATV more stability and better handling. Sold in pairs. Replacement studs available; sold each. Made in the USA.

FITS MODEL	BOLT PATTERN	WIDTH	STUD SIZE	FRONT	REAR	WHEEL SPACER KIT PART-#	REPL. STUD (EA) PART-#
WHEEL SPACERS							
ARCTIC CAT							
250 2X4/4X4 99-03	4/115	1.5"	10MM	X		0222-0180	0222-0300
250 2X4/4X4 98-01	4/115	2.5"	10MM		X	0222-0181	0222-0301
300 2X4/4X4 98-03	4/115	1.5"	10MM	X		0222-0180	0222-0300
300 2X4/4X4 98-03	4/115	2.5"	10MM		X	0222-0181	0222-0301
375 2X4/4X4 02	4/115	1.5"	10MM	X		0222-0180	0222-0300
375 2X4/4X4 02	4/115	2.5"	10MM		X	0222-0181	0222-0301
400 2X4/4X4 98-05	4/115	1.5"	10MM	X		0222-0180	0222-0300
400 2X4/4X4 98-05	4/115	2.5"	10MM		X	0222-0181	0222-0301
454 2X4/4X4 96-98	4/115	1.5"	10MM	X		0222-0180	0222-0300
454 2X4/4X4 96-98	4/115	2.5"	10MM		X	0222-0181	0222-0301
ALL 500 4X4 98-01	4/115	1.5"	10MM	X		0222-0180	0222-0300
ALL 500 4X4 98-01	4/115	2.5"	10MM		X	0222-0181	0222-0301
6501 4X4 04-06	4/115	1.5"	10MM	X		0222-0180	0222-0300
6501 4X4 04-06	4/115	2.5"	10MM		X	0222-0181	0222-0301
CAN-AM							
OUTLANDER 330 2X4/4X4 03-09	4/137	1.5"	10MM	X		0222-0187	0222-0300
OUTLANDER 330 2X4/4X4 03-09	4/137	2.5"	10MM		X	0222-0188	0222-0301
OUTLANDER 400 2X4/4X4 03-11	4/137	1.5"	10MM	X		0222-0187	0222-0300
OUTLANDER 400 2X4/4X4 03-11	4/137	2.5"	10MM		X	0222-0188	0222-0301
TRAXTER 500 4X4 99-05	4/110	1.5"	10MM	X		0222-0177	0222-0300
TRAXTER 500 4X4 99-05	4/110	2.5"	10MM		X	0222-0178	0222-0301
QUEST 500 4X4 00-05	4/110	1.5"	10MM	X		0222-0177	0222-0300
QUEST 500 4X4 00-05	4/110	2.5"	10MM		X	0222-0178	0222-0301
QUEST 650 4X4 00-05	4/110	1.5"	10MM	X		0222-0177	0222-0300
QUEST 650 4X4 00-05	4/110	2.5"	10MM		X	0222-0178	0222-0301
OUTLANDER 650 2X4/4X4 06	4/137	1.5"	10MM	X		0222-0187	0222-0300
OUTLANDER 650 2X4/4X4 06	4/137	2.5"	10MM		X	0222-0188	0222-0301
OUTLANDER 800 2X4/4X4 06	4/137	1.5"	10MM	X		0222-0187	0222-0300
OUTLANDER 800 2X4/4X4 06	4/137	2.5"	10MM		X	0222-0188	0222-0301
E-TON							
YUKON CXL 150 98-03	4/156	1.5"	10MM	X		0222-0182	0222-0300
YUKON CXL 150 98-03	4/110	2.5"	10MM		X	0222-0178	0222-0301
VECTOR 250R 07	4/110	1.5"	10MM	X		0222-0177	0222-0300
VECTOR 250R 07	4/110	2.5"	10MM		X	0222-0178	0222-0301
HONDA							
TRX200 90-93 / 96-97	4/110	1.5"	10MM	X		0222-0177	0222-0300
TRX200 90-93 / 96-97	4/110	2.5"	10MM		X	0222-0178	0222-0301
TRX200SX 86-88	4/110	1.5"	10MM	X		0222-0177	0222-0300
TRX200SX 86-88	4/110	2.5"	10MM		X	0222-0178	0222-0301
ATC200X 83-87	4/110	2.5"	10MM		X	0222-0178	0222-0301
ATC250 BIG RED 85	4/110	2.5"	10MM		X	0222-0178	0222-0301
ATC250SX 85-87	4/110	2.5"	10MM		X	0222-0178	0222-0301
TRX250 BIG RED 86-87	4/110	1.5"	10MM	X		0222-0177	0222-0300
TRX250 BIG RED 86-87	4/110	2.5"	10MM		X	0222-0178	0222-0301
TRX250D & ES RECON 97-06	4/110	1.5"	10MM	X		0222-0177	0222-0300
TRX250D & ES RECON 97-06	4/110	2.5"	10MM		X	0222-0178	0222-0301
TRX300 2X4/4X4 88-00	4/110	1.5"	10MM	X		0222-0177	0222-0300
TRX300 2X4/4X4 88-00	4/110	2.5"	10MM		X	0222-0178	0222-0301
TRX350 4X4 86-92	4/110	1.5"	10MM	X		0222-0177	0222-0300
TRX350 4X4 86-92	4/110	2.5"	10MM		X	0222-0178	0222-0301
RANCHER 350ES 2X4/4X4 00-04	4/110	1.5"	10MM	X		0222-0177	0222-0300
RANCHER 350ES 2X4/4X4 00-04	4/110	2.5"	10MM		X	0222-0178	0222-0301
RANCHER AT 400 2X4/4X4 04	4/110	1.5"	10MM	X		0222-0177	0222-0300
RANCHER AT 400 2X4/4X4 04	4/110	2.5"	10MM		X	0222-0178	0222-0301
TRX400D FOREMAN 96-06	4/110	1.5"	10MM	X		0222-0177	0222-0300
TRX400D FOREMAN 96-06	4/110	2.5"	10MM		X	0222-0178	0222-0301
TRX450S & ES FOREMAN 98-05	4/110	1.5"	10MM	X		0222-0177	0222-0300
TRX450S & ES FOREMAN 98-05	4/110	2.5"	10MM		X	0222-0178	0222-0301
TRX500 FOREMAN 4X4 98-11	4/110	1.5"	10MM	X		0222-0177	0222-0300
TRX500 FOREMAN 4X4 98-11	4/110	2.5"	10MM		X	0222-0178	0222-0301
TRX650 RINCON 4X4 03-06	4/110	1.5"	10MM	X		0222-0177	0222-0300
TRX650 RINCON 4X4 03-06	4/110	2.5"	10MM		X	0222-0178	0222-0301
TRX680 RINCON 06-08	4/110	1.5"	10MM	X		0222-0177	0222-0300
TRX680 RINCON 06-08	4/110	2.5"	10MM		X	0222-0178	0222-0301
BIG RED 09-11	4/110	2.5"	12MM		X	0222-0297	-

CONTINUED ON NEXT PAGE

FITS MODEL	BOLT PATTERN	WIDTH	STUD SIZE	FRONT	REAR	WHEEL SPACER KIT PART#	REPL. STUD (EA) PART#
WHEEL SPACERS							
KAWASAKI							
KLF185 BAYOU 85-87	4/100	2.5"	10MM		X	0222-0186	0222-0301
KLF220 BAYOU 88-02	4/110	1.5"	10MM	X		0222-0177	0222-0300
KLF220 BAYOU 88-02	4/137	2.5"	10MM		X	0222-0188	0222-0301
KLF300 2X4 BAYOU 85-05	4/137	1.5"	10MM	X		0222-0187	0222-0300
KLF300 2X4 BAYOU 85-05	4/137	2.5"	10MM		X	0222-0188	0222-0301
KLF300 4X4 BAYOU 89-05	4/137	1.5"	10MM	X		0222-0187	0222-0300
KLF300 4X4 BAYOU 89-05	4/137	2.5"	10MM		X	0222-0188	0222-0301
KLF300B LAKOTA 95-00	4/156	1.5"	10MM	X		0222-0182	0222-0300
KLF300B LAKOTA 95-00	4/156	2.5"	10MM		X	0222-0183	0222-0301
KVF300 PRAIRIE 2X4/4X4 99-05	4/137	1.5"	10MM	X		0222-0187	0222-0300
KVF300 PRAIRIE 2X4/4X4 99-05	4/137	2.5"	10MM		X	0222-0188	0222-0301
PRAIRIE 360 2X4/4X4 03-10	4/137	1.5"	10MM	X		0222-0187	0222-0300
PRAIRIE 360 2X4/4X4 03-10	4/137	2.5"	10MM		X	0222-0188	0222-0301
KLF400 4X4 BAYOU 93-05	4/137	1.5"	10MM	X		0222-0187	0222-0300
KLF400 4X4 BAYOU 93-05	4/137	2.5"	10MM		X	0222-0188	0222-0301
PRAIRIE 400 2X4/4X4 97-05	4/137	1.5"	10MM	X		0222-0187	0222-0300
PRAIRIE 400 2X4/4X4 97-05	4/137	2.5"	10MM		X	0222-0188	0222-0301
KFX450 08-10	4/110	2.5"	10MM		X	0222-0178	0222-0301
KFX450 08-10	4/144	1.5"	10MM	X		0222-0179	0222-0300
KVF650 PRAIRIE 4X4 03-06	4/137	1.5"	10MM	X		0222-0187	0222-0300
KVF650 PRAIRIE 4X4 03-06	4/137	2.5"	10MM		X	0222-0188	0222-0301
BRUTE FORCE 650I 4X4 06	4/110	1.5"	10MM	X		0222-0177	0222-0300
BRUTE FORCE 650I 4X4 06	4/110	2.5"	10MM		X	0222-0178	0222-0301
BRUTE FORCE 650 05-10	4/137	1.5"	10MM	X		0222-0187	0222-0300
BRUTE FORCE 650 05-10	4/137	2.5"	10MM		X	0222-0188	0222-0301
KFX700 V-FORCE 03-06	4/144	1.5"	10MM	X		0222-0179	0222-0300
KFX700 V-FORCE 03-06	4/137	2.5"	10MM		X	0222-0188	0222-0301
KVF700 PRAIRIE 4X4 03-06	4/137	1.5"	10MM	X		0222-0187	0222-0300
KVF700 PRAIRIE 4X4 03-06	4/137	2.5"	10MM		X	0222-0188	0222-0301
BRUTE FORCE 750 05-10	4/110	1.5"	10MM	X		0222-0177	0222-0300
BRUTE FORCE 750 05-10	4/110	2.5"	10MM		X	0222-0178	0222-0301
TERYX 750 09-11	4/137	2.5"	12MM	X		0222-0299	-
TERYX 750 09-11	4/137	2.5"	12MM		X	0222-0299	-
MULE 500/600 ALL	4/137	1.5"	10MM	X		0222-0187	0222-0300
MULE 500/600 ALL	4/137	2.5"	10MM		X	0222-0188	0222-0301
MULE 1000/2500 ALL	4/137	2.5"	12MM		X	0222-0299	-
POLARIS							
XPLORER 4X4 250 00-02	4/156	1.5"	3/8"	X		0222-0184	0222-0320
TRAIL BLAZER 250/TRAIL BOSS 86-11	4/156	1.5"	3/8"	X		0222-0184	0222-0320
TRAIL BOSS 2X4 250 87-99	4/156	1.5"	3/8"	X		0222-0184	0222-0320
XPRESS 2X4 300 96-99	4/156	1.5"	3/8"	X		0222-0184	0222-0320
XPLORER 4X4 300 90-99	4/156	1.5"	3/8"	X		0222-0184	0222-0320
MAGNUM 300L 2X4 96-99	4/156	1.5"	3/8"	X		0222-0184	0222-0320
MAGNUM 325 2X4/4X4 00-06	4/156	1.5"	3/8"	X		0222-0184	0222-0320
MAGNUM 325 2X4/4X4 02-06	4/156	2.5"	3/8"		X	0222-0185	0222-0321
TRAIL BOSS 2X4 325 00-02	4/156	1.5"	3/8"	X		0222-0184	0222-0320
TRAIL BOSS 2X4 330 03	4/156	1.5"	3/8"	X		0222-0184	0222-0320
TRAIL BOSS 2X4 350L / 400L 90-99	4/156	1.5"	3/8"	X		0222-0184	0222-0320
TRAIL BOSS 4X4 250 / 300 87-95	4/156	1.5"	3/8"	X		0222-0184	0222-0320
TRAIL BOSS 4X4 350 / 400L 90-99	4/156	1.5"	3/8"	X		0222-0184	0222-0320
XPEDITION 2X4 325 00-06	4/156	1.5"	3/8"	X		0222-0184	0222-0320
SPORTSMAN 335 99-06	4/156	1.5"	3/8"	X		0222-0184	0222-0320
SPORTSMAN 335 99-06	4/156	2.5"	3/8"		X	0222-0185	0222-0321
XPRESS 2X4 400L 97	4/156	1.5"	3/8"	X		0222-0184	0222-0320
MAGNUM 400L 2 WD 96-99	4/156	1.5"	3/8"	X		0222-0184	0222-0320
SPORTSMAN 4X4 400L 01-06	4/156	1.5"	3/8"	X		0222-0184	0222-0320
SPORTSMAN 4X4 400L 01-06	4/156	2.5"	3/8"		X	0222-0185	0222-0321
SPORTSMAN 4X4 400 95-98	4/156	1.5"	3/8"	X		0222-0184	0222-0320
XPLORER 4X4 400L 95-03	4/156	1.5"	3/8"	X		0222-0184	0222-0320
XPEDITION 4X4 425 99-06	4/156	1.5"	3/8"	X		0222-0184	0222-0320
DIESEL 4X4 455 99-06	4/156	1.5"	3/8"	X		0222-0184	0222-0320
XPLORER 4X4 500 96-06	4/156	1.5"	3/8"	X		0222-0184	0222-0320
XPLORER 4X4 500 96-06	4/156	2.5"	3/8"		X	0222-0185	0222-0321
MAGNUM 4X4 500 02-05	4/156	1.5"	3/8"	X		0222-0184	0222-0320
MAGNUM 4X4 500 02-05	4/156	2.5"	3/8"		X	0222-0185	0222-0321
SPORTSMAN 500 4X4 96-06	4/156	1.5"	3/8"	X		0222-0184	0222-0320
SPORTSMAN 500 4X4 96-06	4/156	2.5"	3/8"		X	0222-0185	0222-0321
SPORTSMAN 600 03-06	4/156	1.5"	3/8"	X		0222-0184	0222-0320
SPORTSMAN 600 03-06	4/156	2.5"	3/8"		X	0222-0185	0222-0321
SPORTSMAN 700 02-06	4/156	1.5"	3/8"	X		0222-0184	0222-0320
SPORTSMAN 700 02-06	4/156	2.5"	3/8"		X	0222-0185	0222-0321
SPORTSMAN 800 04-06	4/156	1.5"	3/8"	X		0222-0184	0222-0320
SPORTSMAN 800 04-06	4/156	2.5"	3/8"		X	0222-0185	0222-0321
RANGER ALL YEARS/MODELS	4/156	1.5"	3/8"	X		0222-0184'	0222-0320'
RANGER ALL YEARS/MODELS	4/156	2.5"	3/8"		X	0222-0185'	0222-0321'

CONTINUED ON NEXT PAGE

PLOWS

WINCHES

UTV

RACKS

LUGGAGE

BODY

CONTROLS

ELECTRICAL

WHEELS & TIRES

SUSPENSION & DRIVE

ENGINE

NRA BY MODEL

RIDER

TOWING

GARAGE

PROMO

FITS MODEL	BOLT PATTERN	WIDTH	STUD SIZE	FRONT	REAR	WHEEL SPACER KIT PART#	REPL. STUD (EA) PART#
WHEEL SPACERS (CON'T)							
POLARIS (CON'T)							
RZR 08-10	4/156	1.5"	3/8"	X		0222-0184	0222-0320
RZR 08-10	4/156	1.5"	3/8"		X	0222-0184	0222-0320
RZR 08-10	4/156	2.5"	3/8"	X		0222-0185	0222-0321
RZR 08-10	4/156	2.5"	3/8"		X	0222-0185	0222-0321
SUZUKI							
EIGER 400 2X4/4X4 02-07	4/110	1.5"	10MM	X		0222-0177	0222-0300
EIGER 400 2X4/4X4 02-07	4/110	2.5"	10MM		X	0222-0178	0222-0301
VINSON 500 4X4 02-06	4/110	1.5"	10MM	X		0222-0177	0222-0300
VINSON 500 4X4 02-06	4/110	2.5"	10MM		X	0222-0178	0222-0301
TWIN PEAKS 700 4X4 04-06	4/137	1.5"	10MM	X		0222-0187	0222-0300
TWIN PEAKS 700 4X4 04-06	4/137	2.5"	10MM		X	0222-0188	0222-0301
KING QUAD 700 4X4 05-06	4/110	1.5"	10MM	X		0222-0177	0222-0300
KING QUAD 700 4X4 05-06	4/110	2.5"	10MM		X	0222-0178	0222-0301
YAMAHA							
YFB250D TIMBER WOLF 2X4 92-94	4/156	1.5"	10MM	X		0222-0182	0222-0300
YFB250D TIMBER WOLF 2X4 92-94	4/110	2.5"	10MM		X	0222-0178	0222-0301
YFB250D TIMBER WOLF 4X4 95-05	4/110	1.5"	10MM	X		0222-0177	0222-0300
YFB250D TIMBER WOLF 4X4 95-05	4/110	2.5"	10MM		X	0222-0178	0222-0301
YFB250 BEAR TRACKER 99-05	4/110	1.5"	10MM	X		0222-0177	0222-0300
YFB250 BEAR TRACKER 99-05	4/110	2.5"	10MM		X	0222-0178	0222-0301
YFM250 MOTO 4 89	4/110	1.5"	10MM	X		0222-0177	0222-0300
YFM250 MOTO 4 89	4/110	2.5"	10MM		X	0222-0178	0222-0301
BRUIN 250 05-06	4/110	1.5"	10MM	X		0222-0177	0222-0300
BRUIN 250 05-06	4/110	2.5"	10MM		X	0222-0178	0222-0301
YFM350 BRUIN 4 WD 04-06	4/110	1.5"	10MM	X		0222-0177	0222-0300
YFM350 BRUIN 4 WD 04-06	4/110	2.5"	10MM		X	0222-0178	0222-0301
YFM350 WOLVERINE 95-06	4/110	1.5"	10MM	X		0222-0177	0222-0300
YFM350 WOLVERINE 95-06	4/110	2.5"	10MM		X	0222-0178	0222-0301
YFM350/400 BIG BEAR 87-06	4/110	1.5"	10MM	X		0222-0177	0222-0300
YFM350/400 BIG BEAR 87-06	4/110	2.5"	10MM		X	0222-0178	0222-0301
YFM400/450 KODIAK 2X4/4X4 93-06	4/110	1.5"	10MM	X		0222-0177	0222-0300
YFM400/450 KODIAK 2X4/4X4 93-06	4/110	2.5"	10MM		X	0222-0178	0222-0301
YFM450 WOLVERINE 06-08	4/110	1.5"	10MM	X		0222-0177	0222-0300
YFM450 WOLVERINE 06-08	4/110	2.5"	10MM		X	0222-0178	0222-0301
YFM600 GRIZZLY 4X4 98-11	4/110	1.5"	10MM	X		0222-0177	0222-0300
YFM600 GRIZZLY 4X4 98-11	4/110	2.5"	10MM		X	0222-0178	0222-0301
YFM660 GRIZZLY 4X4 02-11	4/110	1.5"	10MM	X		0222-0177	0222-0300
YFM660 GRIZZLY 4X4 02-11	4/110	2.5"	10MM		X	0222-0178	0222-0301
RHINO 450/660/700 04-11	4/110	1.5"	10MM	X		0222-0177	0222-0300
RHINO 450/660/700 04-11	4/110	1.5"	10MM	X		0222-0177	0222-0300
RHINO 450/660/700 04-11	4/110	2.5"	10MM		X	0222-0178	0222-0301
RHINO 450/660/700 04-11	4/110	2.5"	10MM		X	0222-0178	0222-0301

*NOT FOR RANGER 900 13 MODEL



QUALIFIER BRAKE PADS > \$19.95

Latest generation of *Keular®* based organic material. Progressive feel and rider feedback. No rotor wear and quiet. Imported.



FITS MODEL	FRONT PART #	REAR PART #
QUALIFIER BRAKE PADS		
ARCTIC CAT		
ALL DISC BRAKE MODELS (EXCEPT BELOW) 96-04	1720-0236	1720-0236
BEARCAT 96-97	1720-0236	1720-0236
BEARCAT 98	1720-0236	1720-0236
250 2X4/4X4 05-06	1720-0232	1720-0232
300 4X4 05	1720-0232	1720-0232
336 ATV 09-10	1720-0232	1720-0232
400 ATV TRV 09-10	1720-0232	1720-0232
400 4X4 FIS (MANUAL TRANSMISSION) 05-07	1720-0232	1720-0232
PARKING BRAKE 400 4X4 FIS (MANUAL TRANSMISSION) 05-07	1720-0236	1720-0236
425 ATV CR/INTL 2012	1720-0232	1720-0232
450 ATV/TRV/INTL 2012	1720-0232	1720-0232
500 FIS (MANUAL AND AUTOMATIC) 05-10	1720-0232	1720-0232
PARKING BRAKE 500 FIS (MANUAL AND AUTOMATIC) 05-10	1720-0236	-
500 TRV (AUTOMATIC) 05	1720-0232	1720-0232
550 HI/TRV/GT/LTD ED INTL/CRUISER 09-12	1720-0232	1720-0232
650 (4X4 AUTO/AUTO LE) 04-08	1720-0232	1720-0232
PARKING BRAKE 650 (4X4 AUTO/AUTO LE) 04-08	1720-0236	-
650H (4X4 AUTO) 05	1720-0232	1720-0232
PARKING BRAKE 650H (4X4 AUTO) 05	1720-0236	-
650 ATV TRV/HI MUD PRO 09-12	1720-0232	1720-0232
550 PROWLER 09-11	1720-0232	1720-0232
XT650 PROWLER 06-09	1720-0232	1720-0232
650 TBX 09-10	1720-0232	1720-0232
700 4X4 AUTO 06-08	1720-0232	1720-0232
700 HI/EFI/DIESEL/TRV/TRV CRUISER/GT 08-12	1720-0232	1720-0232
700 ATV HI/MUD PRO/DIESEL/GT/LTD 09-12	1720-0232	1720-0232
700 PROWLER XT 09-12 (ALL MODELS)	1720-0232	1720-0232
700 TBX GT	1720-0232	1720-0232
1000 ATV H2 EFI MUD PRO/GT/INTL 11-12	1720-0232	1720-0232
1000 H2 CRUISER/TRV 09-10	1720-0232	1720-0232
1000 THUNDERCAT 08-10	1720-0232	1720-0232
CAN-AM		
330/400/500 OUTLANDER 03-13 (LH)	1720-0233	1720-0234
330/400/500 OUTLANDER 03-13(RH)	1720-0234	-
500 OUTLANDER 07-12 ALL (LH)	1720-0233	1720-0234
500 OUTLANDER 07-12 ALL (RH)	1720-0234	-
500 QUEST 02-04 (LH)	1720-0233	1720-0233
500 QUEST 02-04 (RH)	1720-0234	-
500 TRAXTER 01-05 (RH)	1720-0234	-
500 TRAXTER 01-05 (LH)	1720-0233	1720-0234
500 RENEGADE 08-12(RH)	1720-0234	-
500 RENEGADE 08-12 (LH)	1720-0233	1720-0234
OUTLANDER/OUTLANDER MAX 650 06-13 (ALL) (LH)	1720-0233	-
OUTLANDER/OUTLANDER MAX 650 06-13 (ALL) (RH)	1720-0234	1720-0234
QUEST 650 02-04 (RH)	1720-0234	1720-0233
QUEST 650 02-04 (LH)	1720-0233	-
650 TRAXTER CVT/MAX 05 (RH)	1720-0234	-
650 TRAXTER CVT/MAX 05 (LH)	1720-0233	1720-0233
800 COMMANDER /R 11-13 (RH)	-	1720-0237
800 COMMANDER /R 11-13 (LH)	1720-0238	-
800 OUTLANDER H.O./XT / MAX (RH) 06-13	1720-0234	1720-0234
800 OUTLANDER H.O./XT / MAX(LH) 06-13	1720-0233	-
800 RENEGADE 08-11 (LH)	1720-0234	-
800 RENEGADE 08-11 (RH)	1720-0233	1720-0234
1000 COMMANDER 11-13 (RH)	1720-0237	1720-0237
1000 COMMANDER 11-13 (LH)	1720-0238	-
CANNONDALE		
ALL MODELS 00-03 (LH)	1720-0233	1720-0234
ALL MODELS 00-03 (RH)	1720-0234	-
E-TON		
YXL150 YUKON 02-06 (DISC)	-	1720-0238
CXL150 CHALLENGER 03-10 (DISC)	-	1720-0238
RXL VIPER 150 05-10	-	1720-0238
HONDA		
TRX420 FOURTRAX RANCHER 07-13	1720-0229	-
TRX500 FOURTRAX FOREMAN4X4 /RUBICON 12-13	1720-0229	-

FITS MODEL	FRONT PART #	REAR PART #
QUALIFIER BRAKE PADS (CONT)		
JOHN DEERE		
TRAIL BUCK 500/650 04-05 (ALL) (RH)	1720-0234	1720-0233
TRAIL BUCK 500/650 04-05 (ALL) (LH)	1720-0233	-
KAWASAKI		
KLF300C BAYOU 4X4 89-05 (RH)	1720-0238	-
KLF300C BAYOU 4X4 89-05 (LH)	1720-0237	-
KVF300 PRAIRIE 2X4/4X4 99-02	1720-0231	-
KVF360 PRAIRIE 03-13 (ALL)	1720-0231	-
KLF400 BAYOU 93-99 (LH)	1720-0237	-
KLF400 BAYOU 93-99 (RH)	1720-0238	-
KVF400C/D PRAIRIE 2WD/4WD 97-02	1720-0231	-
KVF650E/F/H BRUTE FORCE 4X4 06-13 (LH)	1720-0237	-
KVF650E/F/H BRUTE FORCE 4X4 06-13 (RH)	1720-0238	-
KVF750 BRUTE FORCE 4X4 04-13 I (RH)	1720-0238	-
KVF750 BRUTE FORCE 4X4 04-13 I (LH)	1720-0237	-
KRF750 TERYX 08-13 (LH)	1720-0237	-
KRF750 TERYX 08-13 (RH)	1720-0238	-
POLARIS		
DISC BRAKE MODELS 88-94	1720-0230	-
DISC BRAKE MODELS 95-98	1720-0230	-
250 RANGER 2X4/4X4 02-05	1720-0230	1720-0233
250 TRAILBLAZER ES 99-04	1720-0230	1720-0235
250 TRAIL BOSS 98-01	1720-0230	-
250 TRAILBLAZER 94-98	1720-0230	-
250 XPLODER 00-01	1720-0230	1720-0235
250 XPLODER 4X4 00-01	1720-0230	-
300 HAWKEYE 2X4/4X4 06	1720-0230	1720-0232
300 HAWKEYE 2X4 07-11	1720-0230	1720-0230
300 SPORTSMAN 4X4 08-10	1720-0230	1720-0230
300 XPLODER 96-01	1720-0230	-
300 XPRESS 96-00	1720-0230	-
325 MAGNUM 2X4/4X4 00-01	1720-0230	1720-0235
325 MAGNUM 2X4 02	1720-0230	1720-0240
325 TRAIL BOSS 00	1720-0230	1720-0235
325 TRAIL BOSS 01-02	1720-0230	1720-0235
330 ATP 4X4 04-06	1720-0230	1720-0230
330 MAGNUM 2X4/4X4 HDS 03-06	1720-0230	1720-0240
330 TRAIL BLAZER 05-13	1720-0230	1720-0240
330 TRAIL BOSS 03-04	1720-0230	1720-0235
330 TRAIL BOSS 05-13	1720-0230	1720-0240
335 SPORTSMAN 98-00	1720-0230	1720-0235
350L SPORTSMAN/TRAIL BOSS 90-93	1720-0230	-
400 BIG BOSS L 6X6 (MIDDLE AXLE BRAKE) 94-97	1720-0230	-
400 RANGER 4X4 10-13	1720-0242	1720-0242
400 SPORTSMAN 01-02	1720-0230	1720-0235
400 SPORTSMAN 03-05	1720-0230	1720-0240
400 SPORTSMAN HO 4X4 08-10	1720-0230	1720-0230
400 SPORTSMAN HO 4X4 11-13	1720-0230	-
400 TRAIL BLAZER 03	1720-0230	1720-0235
400 XPLODER 99-02	1720-0230	1720-0235
400 XPLODER 98	1720-0230	-
425 MAGNUM 6X6 96-01	1720-0230	-
425 MAGNUM 95-98	1720-0230	-
425 XPEDITION 4X4 00	1720-0230	1720-0235
425 XPEDITION 4X4 02	1720-0230	1720-0235
450 SPORTSMAN 06-07	1720-0230	1720-0240
455 DIESEL 99-00	1720-0230	-
455 DIESEL EBS 4X4 99-01	1720-0230	1720-0235
500 ATP 04-05	1720-0230	1720-0240
500 MAGNUM 00-01	1720-0230	1720-0235
500 MAGNUM 2X4/4X4 02-03	1720-0230	1720-0235
500 MAGNUM RMK 4X4 02	1720-0230	1720-0240
500 RANGER 4X4 EFI 2010	-	1720-0242
500 RANGER 4X4 EFI/EFI/CREW 10-13	1720-0242	1720-0242
500 SPORTSMAN 6X6 00-06	1720-0230	1720-0240
500 SPORTSMAN 98-02	1720-0230	1720-0235
500 SPORTSMAN EBS 4X4 98-01	1720-0230	1720-0235
500 SPORTSMAN REMINGTON SPECIAL EDITION 98	1720-0230	1720-0235
500 SPORTSMAN EFI/HQ/X2 03-09 (ALL)	1720-0230	1720-0240
500 SPORTSMAN HO /INTL 10-13	1720-0230	-
500 SPORTSMAN TOURING HQ/INTL 10-13	1720-0230	1720-0242
500 SPORTSMAN FOREST 11-13	1720-0230	1720-0240
500 SPORTSMAN FOREST TRACTOR 11	1720-0230	-
550 SPORTSMAN EPS 09-10	-	1720-0230
600 SPORTSMAN 03-05	1720-0230	1720-0240
700 SPORTSMAN 4X4 02-07 (ALL)	1720-0230	1720-0240

CONTINUED ON NEXT PAGE

PLOWS
WINCHES
UTV
RACKS
LUGGAGE
BODY
CONTROLS
ELECTRICAL
WHEELS & TIRES
SUSPENSION & DRIVE
ENGINE
NRA BY MOOSE
RIDER
TOWING
GARAGE
PROMO

FITS MODEL	FRONT PART #	REAR PART #
QUALIFIER BRAKE PADS (CON'T)		
POLARIS (CON'T)		
700 SPORTSMAN 4X4 X2 08	1720-0230	1720-0230
800 SPORTSMAN EFI/HO 05-08	1720-0230	1720-0240
800 SPORTSMAN TOURING 08-09	1720-0230	1720-0240
800 SPORTSMAN EFI/HO 09-11	1720-0230	-
800 SPORTSMAN EFI 6X6 10-13	1720-0230	1720-0240
800 SPORTSMAN FOREST 12-13	1720-0230	-
800 SPORTSMAN FOREST 6X6 12-13	1720-0230	1720-0240
800 SPORTSMAN X2 07-09	1720-0230	1720-0230
800 RANGER RZR 08-11	-	1720-0230
800 RANGER RZR-4 EFI/EPS 10-13	-	1720-0242
800 RANGER RZR EFI/EPS 10-13	-	1720-0230
800 RANGER RZR S/EFI/INTL 09-13	-	1720-0230
800 RANGER XP 12-13	-	1720-0242
800 RANGER 4X4 EFI 10-11	-	1720-0242
900 RANGER DIESEL 12-13	-	1720-0242
900 RANGER RZR XP 11-13	-	1720-0242
SUZUKI		
LT230E 86-93	-	1720-0229
LT230S 85-88	-	1720-0229
LT250SK/SL 89-90	-	1720-0229
LT-F250 OZARK 02-13	1720-0231	-
LT-F300 KING QUAD 02-03 (RH)	1720-0238	-
LT-F300 KING QUAD 02-03 (LH)	1720-0237	-
LT-A/LT-F400 EIGER 02-07	1720-0231	-
400 KING QUAD ASI/FSI 08-12 (RH)	1720-0233	-
400 KING QUAD ASI/FSI 08-12 (LH)	1720-0234	-
KING QUAD 450 07-10 (RH)	1720-0233	-
KING QUAD 450 07-10 (LH)	1720-0234	-
LT-A500 X KING QUAD 09-13 (LH)	1720-0234	-
LT-A500 X KING QUAD 09-13 (RH)	1720-0233	-
LT-A500 VINSON 4WD 02	1720-0231	1720-0233
LT-A500 VINSON 4WD 03-07	1720-0231	-
LT-F500 QUADRUNNER 98-02 (RH)	1720-0238	-
LT-F500 QUADRUNNER 98-02 (LH)	1720-0237	-
LT-F500 VINSON 03-08 (ALL)	1720-0229	-
LT-A700 KING QUAD 05-07 (LH)	1720-0234	-
LT-A700 KING QUAD 05-07 (RH)	1720-0233	-
LT-A750 KING QUAD 08-13 (LH)	1720-0234	-
LT-A750 KING QUAD 08-13 (RH)	1720-0233	-
YAMAHA		
YFM250 BEAR TRACKER 01-04	1720-0231	-
YFM250 BRUIN 05-06	1720-0231	-
YFM250 BIG BEAR 07-09	1720-0231	-
YFM350 BIG BEAR 99	1720-0231	-
YFM350 BRUIN 2X4/4X4 04-06	1720-0231	-
YFM350FX WOLVERINE 4WD 95-05	1720-0231	1720-0229
YFM350V WOLVERINE 2WD 06-09	1720-0231	-
YFM350 GRIZZLY 2X4/4X4 AUTO 07-10	1720-0231	-
YFM350 GRIZZLY 4X4 IRS 07-10	1720-0231	-
YFM350 GRIZZLY 2WD/4WD/IRS 4WD 2011	1720-0229	-
YFM350 2012	1720-0229	-
YFM400 KODIAK 00-02	1720-0231	1720-0239
YFM400 BIG BEAR 00-04 (ALL)	1720-0231	-
YFM400 BIG BEAR 05-10	1720-0231	-
YFM400 BIG BEAR 11-12	1720-0229	-
YFM400F BIG BEAR 4X4/KODIAK AUTO 05-06	1720-0231	1720-0239
YFM400 GRIZZLY 4X4 07-08	1720-0231	1720-0239
YFM400 GRIZZLY 4X4 IRS 07-08	1720-0231	1720-0239
YFM400FWL KODIAK 00-02	1720-0231	1720-0239
YFM400 KODIAK 2X4/4X4 03-04	1720-0231	-
YFM400 KODIAK 05	1720-0231	1720-0239
YFM450 KODIAK 03-06	1720-0231	1720-0239
YFM 450 KODIAK IRS 06	1720-0231	1720-0239
YFM450 WOLVERINE 06-10	1720-0231	1720-0239
YFM450 GRIZZLY 4X4 07-10	1720-0231	1720-0239
YFM450 GRIZZLY 4X4 IRS 09-10	1720-0231	-
YFM450 GRIZZLY 4WD/EPS 11-13	1720-0229	-
YXR450 RHINO 06-09 (RH)	1720-0238	-
YXR450 RHINO 06-09 (LH)	1720-0237	-
YFM600 GRIZZLY 98-01 (ALL)	1720-0229	-
YFM660F GRIZZLY 02-08 (ALL)	1720-0229	-
YXR660 RHINO 4X4 04-07 (RH)	1720-0238	-
YXR660 RHINO 4X4 04-07 (LH)	1720-0237	-
YXR700 RHINO 4X4 08-13 (RH)	1720-0238	1720-0238
YXR700 RHINO 4X4 08-13 (LH)	1720-0237	1720-0237



BRAKE PADS & SHOES BY DP BRAKES > \$16.95-\$46.95

Pads are constructed of durable sintered metal which stands up to the toughest conditions and provides equal braking power, wet or dry. Brake shoes are asbestos-free and offer durability and performance. Imported.

FITS MODEL	FRONT PART #	REAR PART #
BRAKE PADS & SHOES		
ARCTIC CAT		
ALL DISC BRAKE MODELS (EXCEPT BELOW) 96-04	M914-S47	M914-S47
50 YOUTH 2X4 04-06	1723-0139	1723-0133
50 DVX 06	1723-0139	-
90 YOUTH 2X4 02-06	1723-0139	1723-0133
BEARCAT 96-97	M914-S47	M914-S47
BEARCAT 98	M914-S47	M914-S47
250 2X4/4X4 05-06	1721-0621	1721-0621
300 4X4 05	1721-0621	1721-0621
336 ATV 09-10	1721-0621	1721-0621
400 ATV TRV 09-10	1721-0621	1721-0621
400 4X4 FIS (MANUAL TRANSMISSION) 05-07	1721-0621	1721-0621
PARKING BRAKE 400 4X4 FIS (MANUAL TRANSMISSION) 05-07	M914-S47	M914-S47
425 ATV CR/INTL 2012	1721-0621	1721-0621
450 ATV/TRV/INTL 2012	1721-0621	1721-0621
500 FIS (MANUAL AND AUTOMATIC) 05-10	1721-0621	1721-0621
PARKING BRAKE 500 FIS (MANUAL AND AUTOMATIC) 05-10	M914-S47	-
500 TRV (AUTOMATIC) 05	1721-0621	1721-0621
550 HI/TRV/GT/LTD ED INTL/CRUISER 09-12	1721-0621	1721-0621
650 (4X4 AUTO/AUTO LE) 04-08	1721-0621	1721-0621
PARKING BRAKE 650 (4X4 AUTO/AUTO LE) 04-08	M914-S47	-
650H (4X4 AUTO) 05	1721-0621	1721-0621
PARKING BRAKE 650H (4X4 AUTO) 05	M914-S47	-
650 ATV TRV/HI MUD PRO 09-12	1721-0621	1721-0621
550 PROWLER 09-11	1721-0621	1721-0621
XT650 PROWLER 06-09	1721-0621	1721-0621
650 TBX 09-10	1721-0621	1721-0621
700 4X4 AUTO 06-08	1721-0621	1721-0621
700 HI/EFI/DIESEL/TRV/TRV CRUISER/GT 08-12	1721-0621	1721-0621
700 ATV HI/MUD PRO/DIESEL/GT/LTD 09-12	1721-0621	1721-0621
700 PROWLER XT 09-12 (ALL MODELS)	1721-0621	1721-0621
700 TBX GT	1721-0621	1721-0621
1000 ATV H2 EFI MUD PRO/GT/INTL 11-12	1721-0621	1721-0621
1000 H2 CRUISER/TRV 09-10	1721-0621	1721-0621
1000 THUNDERCAT 08-10	1721-0621	1721-0621
CAN-AM		
200 RALLY 03-04	M312-S47	-
200 RALLY 05-07	M312-S47	-
330/400/500 OUTLANDER 03-12 (LH)	M919-S47	M920-S47
330/400/500 OUTLANDER 03-12(RH)	M920-S47	-
500 OUTLANDER 07-12 ALL (LH)	M919-S47	M920-S47
500 OUTLANDER 07-12 ALL (RH)	M920-S47	-
500 QUEST 02-04 (LH)	M919-S47	M919-S47
500 QUEST 02-04 (RH)	M920-S47	-
500 TRAXTER 01-05 (RH)	M920-S47	-
500 TRAXTER 01-05 (LH)	M919-S47	M920-S47
500 RENEGADE 08-12(RH)	M920-S47	-
500 RENEGADE 08-12 (LH)	M919-S47	M920-S47
OUTLANDER/OUTLANDER MAX 650 06-13 (ALL) (LH)	M919-S47	-
OUTLANDER/OUTLANDER MAX 650 06-13 (ALL) (RH)	M920-S47	M920-S47
QUEST 650 02-04 (RH)	M920-S47	M919-S47
QUEST 650 02-04 (LH)	M919-S47	-
650 TRAXTER CVT/MAX 05 (RH)	M920-S47	-
650 TRAXTER CVT/MAX 05 (LH)	M919-S47	M919-S47
800 COMMANDER /R 11-12 (RH)	M411-S47	M411-S47
800 COMMANDER /R 11-12 (LH)	M412-S47	-
800 OUTLANDER H.O./XT/MAX (RH) 06-12	M920-S47	-
800 OUTLANDER H.O./ XT / MAX (LH) 06-12	M919-S47	M920-S47
800 R OUTLANDER STD/XT/EFI 12-13 (LH)	1721-1445	1721-1446
800 R OUTLANDER STD/XT/EFI 12-13 (RH)	1721-1446	-
800 RENEGADE 08-13 (LH)	M920-S47	-
800 RENEGADE 08-13 (RH)	M919-S47	M920-S47
1000 MAVERICK STD & XRS 13 (RH)	M411-S47	M919-S47

CONTINUED ON NEXT PAGE

FITS MODEL	FRONT PART #	REAR PART #
BRAKE PADS & SHOES (CON'T)		
CAN-AM (CON'T)		
1000 MAVERICK STD & XRS 13 (LH)	M412-S47	M920-S47
1000 COMMANDER 11-13 (RH)	M411-S47	M411-47
1000 COMMANDER 11-13 (LH)	M412-S47	-
1000 OUTLANDER STD/XI/EFI 12-13 (LH)	1721-1445	1721-1446
1000 OUTLANDER STD/XI/EFI 12-13 (RH)	1721-1446	-
CANNONDALE		
ALL MODELS 00-03 (LH)	M919-S47	M920-S47
ALL MODELS 00-03 (RH)	M920-S47	-
E-TON		
IXL40 RASCAL 98-01	-	1723-0133
JXL40 VIPER JR. 01-06	-	1723-0133
TXL50 WIZZ 98-99	1723-0138	1723-0133
AXL50 LIGHTNING 99-00	1723-0138	1723-0133
NXL50 LIGHTNING 01-02	1723-0138	1723-0133
RXL50 VIPER 02	1723-0138	1723-0133
RXL50/70 VIPER 03-06 (DISC)	1723-0138	M312-S47
RXL70 05-06	1723-0138	1723-0133
TXL80 WIZZ 98-99	1723-0138	1723-0133
AXL90 THUNDER 99-00	1723-0138	1723-0133
NXL90 THUNDER 01-02	1723-0138	1723-0133
RXL90 VIPER 02	1723-0138	1723-0133
RXL90 VIPER 03-06 (DISC)	1723-0138	M312-S47
DXL90 SIERRA/RANGER 99-05	1723-0017	1723-0133
YXL150 YUKON 00-02	1723-0017	1723-0133
YXL150 YUKON 02-06 (DISC)	M9100	M412-S47
CXL150 CHALLENGER 02	M9100	1723-0133
CXL150 CHALLENGER 03-10 (DISC)	M9100	M412-S47
RXL VIPER 150 05-10	M9100	M412-S47
VXL 250 VECTOR 06-10 ST	M312-S47	M312-S47
HONDA		
ATC70 76-77	-	M9100
ATC70 78-85	-	-
TRX70 86-87	1723-0139	1723-0133
ATC90 73-78	-	M9122
TRX90 FOURTRAX/SPORTRAX/EX/X 93-12	M9100	M9122
ATC110 79-85	-	M9122
ATC125 84-87	M9100	M9122
TRX125 85-88	M9100	M9122
ATC185 80-83	M9100	M9122
ATC200E/ES BIG RED 81-84	M9100	M9122
ATC200 84-86	M9100	M9122
ATC200X 83-85	M811-S47	M811-S47
ATC200X 86-87	M811-S47	M811-S47
TRX200 84	M9146	M9122
TRX200/SX 86-98	M9149	M9122
ATC250ES BIG RED 85-87	M9122	M9119
ATC250R 85-86	M812-S47	M812-S47
ATC250SX 85-87	M9122	M9119
FL250 ODYSSEY 77-83	-	M9122
FL250 ODYSSEY 84	-	M9122
TRX250 85-87	M9146	M9119
TRX250 RECON 97-13	M9149	M9186
TRX300 2WD 88-00	M9149	M9119
TRX300 4WD 88-00	M9150	M9119
FL350 ODYSSEY 85-87	M9146	-
TRX350/D 86-89	-	1723-0136
TRX350 RANCHER 00-06 (ALL)	M9150	M9167
FL400R PILOT 89-90	M9146	-
TRX400FW 4WD 95-02	M9150	M9167
TRX400FA/FGA FOURTRAX FOREMAN AT 04-08	M9150	M9167
TRX420 FOURTRAX RANCHER 07-13	M811-S47	M9167
TRX450ES/S 98-03	M9150	M9167
TRX500 RUBICON 01-04	M9150	1723-0136
TRX500 RUBICON 05-11	1721-0622	1723-0136
TRX500 FOURTRAX FOREMAN 2X4/4X4 05-11	1721-0622	1723-0136
TRX500 FOURTRAX FOREMAN 4X4/RUBICON 12-13	M811-S47	1723-0136
TRX650 RINCON 03-05	M9150	1721-0748
TRX680 FOURTRAX RINCON/GPSCAPE 06-08	M9150	1721-0748
TRX680 FOURTRAX RINCON/GPSCAPE 09-13	1721-0622	1721-0748
JOHN DEERE		
TRAIL BUCK 500/650 04-05 (ALL) (RH)	M920-S47	M919-S47
TRAIL BUCK 500/650 04-05 (ALL) (LH)	M919-S47	-
KAWASAKI		
KLF110 MOJAVE 86-88	1723-0001	-
KLT110 84-86	1723-0001	-

FITS MODEL	FRONT PART #	REAR PART #
BRAKE PADS & SHOES (CON'T)		
KAWASAKI (CON'T)		
KLT160 85	1723-0001	-
KLF185 85	-	M9117
KLF185 BAYOU 86-88	M9161	M9117
KLT185 86-87	1723-0001	-
KLT200 81-84	1723-0001	M9161
KLF220 BAYOU 88-02	M9161	M9117
KLF250 BAYOU 03-11	M9161	M9117
KLT250 82-85	1723-0001	M9161
KLT250C 84	1723-0001	M9161
KAF300 (MULE 500) 92-95	M9158	M9202
KAF300C (MULE 550) 97-00	M9158	M9202
KAF300D (MULE 250)	M9158	M9202
KEF300 LAKOTA 95-00	M821-S47	M811-S47
KEF300 LAKOTA SPORT 01-04	M821-S47	M811-S47
KLF300 BAYOU 86-87	M9162	M9117
KLF300B BAYOU 2X4 88-04	M310-S47	M9117
KLF300C BAYOU 4X4 89-05 (RH)	M412-S47	-
KLF300C BAYOU 4X4 89-05 (LH)	M411-S47	M9145
KVF300 PRAIRIE 2X4/4X4 99-02	M107-S47	M9145
KVF360 PRAIRIE 03-13 (ALL)	M107-S47	-
KAF400 (MULE 600 4X4) 06-13	M9202	M9202
KAF400 (MULE 610 XC/4X4 XC) 10-13	M9202	M9202
KLF400 BAYOU 93-99 (LH)	M411-S47	M9145
KLF400 BAYOU 93-99 (RH)	M412-S47	-
KVF400C/D PRAIRIE 2WD/4WD 97-02	M107-S47	M9145
KAF450B (MULE 1000)	M9203	M9204
KAF540C/D/E (MULE 2010/2020/2030)	M9203	M9204
KAF620A/B/C (MULE 2500/2510/2520)	M9203	M9204
KAF620E/F/G (MULE 3000/3010/3020)	M9203	M9204
KAF620 MULE 3100 4X4 03-05	M9203	M9204
KAF620 N9F/NFG/M9F/MAF (MULE 4010 4X4) 09-13	M9203	M9204
KAF620 P9F/PAF (MULE 4000/4X4) 09-13	M9203	M9204
KVF650A1 PRAIRIE 02-03 (RH)	M326-S47	M929-S47
KVF650A1 PRAIRIE 02-03 (LH)	M929-S47	-
KVF650D/E BRUTE FORCE 4X4 04-13 (RH)	M326-S47	-
KVF650D/E BRUTE FORCE 4X4 04-13 (LH)	M929-S47	-
KVF650E/F/H BRUTE FORCE 4X4 06-13 (LH)	M411-S47	-
KVF650E/F/H BRUTE FORCE 4X4 06-13 (RH)	M412-S47	-
KXF700 FORCE 04-10 (RH)	M326-S47	-
KXF700 FORCE 04-10 (LH)	M929-S47	-
KVF700 PRAIRIE 4X4 04-06 (ALL) (RH)	M326-S47	-
KVF700 PRAIRIE 4X4 04-06 (ALL) (LH)	M929-S47	-
KVF750 BRUTE FORCE 4X4 04-13 I (RH)	M412-S47	-
KVF750 BRUTE FORCE 4X4 04-13 I (LH)	M411-S47	-
KRF750 TERYX 08-13 (LH)	M411-S47	-
KRF750 TERYX 08-13 (RH)	M412-S47	-
KAF920A2 MULE 2510 DIESEL 02	M9203	M9204
KAF950A/B (MULE 2510/3010 DIESEL) 03-05	M9203	M9204
POLARIS		
DRUM BRAKE MODELS 86	M9111	-
DISC BRAKE MODELS 88-94	M902-S47	-
DISC BRAKE MODELS 95-98	M902-S47	M909-S47
200 PHOENIX 06-13	M312-S47	M9122
200 SAWTOOTH 06-08	M312-S47	M9122
250 RANGER 2X4/4X4 02-05	M902-S47	M919-S47
250 TRAILBLAZER ES 99-05	M902-S47	M915-S47
250 TRAIL BOSS 98-01	M902-S47	M909-S47
250 TRAILBLAZER 94-98	M902-S47	M909-S47
250 XPLODER 00-01	M902-S47	M915-S47
250 XPLODER 4X4 00-01	M902-S47	M909-S47
300 HAWKEYE 2X4/4X4 06	M902-S47	1721-0621
300 HAWKEYE 2X4 07-11	M902-S47	M902-S47
300 SPORTSMAN 4X4 08-10	M902-S47	M902-S47
300 XPLODER 96-01	M902-S47	M909-S47
300 XPRESS 96-00	M902-S47	M909-S47
325 MAGNUM 2X4/4X4 00-01	M902-S47	M915-S47
325 MAGNUM 2X4 02	M902-S47	M932-S47
325 TRAIL BOSS 00	M902-S47	M915-S47
325 TRAIL BOSS 01-02	M902-S47	M915-S47
330 ATP 4X4 04-06	M902-S47	M902-S47
330 MAGNUM 2X4/4X4 HDS 03-06	M902-S47	M932-S47
330 TRAIL BLAZER 05-13	M902-S47	M932-S47
330 TRAIL BOSS 03-04	M902-S47	M915-S47
330 TRAIL BOSS 05-07	M902-S47	M915-S47
330 TRAIL BOSS 05-12	M902-S47	M932-S47

CONTINUED ON NEXT PAGE

PLOWS

WINCHES

UTV

RACKS

LUGGAGE

BODY

CONTROLS

ELECTRICAL

WHEELS & TIRES

SUSPENSION & DRIVE

ENGINE

NRA BY MOOSE

RIDER

TOWING

GARAGE

PROMO

FITS MODEL	FRONT PART #	REAR PART #
BRAKE PADS & SHOES (CON'T)		
POLARIS (CON'T)		
335 SPORTSMAN 98-00	M902-S47	M915-S47
350L SPORTSMAN/TRAIL BOSS 90-93	M902-S47	M909-S47
400 BIG BOSS L 6X6 (MIDDLE AXLE BRAKE) 94-97	M902-S47	M909-S47
400 RANGER 4X4 10-13	1721-1230	1721-1230
400 SPORTSMAN 01-02	M902-S47	M915-S47
400 SPORTSMAN 03-05	M902-S47	M932-S47
400 SPORTSMAN HO 4X4 08-10	M902-S47	M902-S47
400 SPORTSMAN HO 4X4 11-13	M902-S47	1721-1228
400 TRAIL BLAZER 03	M902-S47	M915-S47
400 XPLORER 99-02	M902-S47	M915-S47
400 XPLORER 98	M902-S47	M909-S47
425 MAGNUM 6X6 96-01	M902-S47	-
425 MAGNUM 95-98	M902-S47	M909-S47
425 XPEdition 4X4 00	M902-S47	M915-S47
425 XPEdition 4X4 02	M902-S47	M915-S47
450 SPORTSMAN 06-07	M902-S47	M932-S47
455 DIESEL 99-00	M902-S47	M909-S47
455 DIESEL EBS 4X4 99-01	M902-S47	M915-S47
500 ATP 04-05	M902-S47	M932-S47
500 MAGNUM 00-01	M902-S47	M915-S47
500 MAGNUM 2X4/4X4 02-03	M902-S47	M915-S47
500 MAGNUM RMK 4X4 02	M902-S47	M932-S47
500 RANGER 4X4 EFI 2010	1721-1229	1721-1230
500 RANGER 4X4 /EFI/CREW 11-13	1721-1230	1721-1230
500 SPORTSMAN 6X6 00-06	M902-S47	M932-S47
500 SPORTSMAN 98-02	M902-S47	M915-S47
500 SPORTSMAN EBS 4X4 98-01	M902-S47	M915-S47
500 SPORTSMAN REMINGTON SPECIAL EDITION 98	M902-S47	M915-S47
500 SPORTSMAN EFI/HO/X2 03-09 (ALL)	M902-S47	M932-S47
500 SPORTSMAN HO 10-12	M902-S47	1721-1228
500 SPORTSMAN TOURING HO 10-13	M902-S47	1721-1230
500 SPORTSMAN TOURING INTL 10-13	M902-S47	M932-S47
500 SPORTSMAN FOREST 11-13	M902-S47	M932-S47
500 SPORTSMAN FOREST TRACTOR 2011	M902-S47	1721-1228
550 SPORTSMAN EPS 09-10	1721-0836	M902-S47
550 SPORTSMAN EPS INTL 09-10	1721-1228	1721-1228
550 SPORTSMAN X2 10-13	1721-1228	1721-1228
550 SPORTSMAN XP 09-13	1721-1228	1721-1228
550 SPORTSMAN /TOURING EPS 09-13	1721-1228	1721-1228
550 SPORTSMAN FOREST 11-12	1721-1228	1721-1228
600 SPORTSMAN 03-05	M902-S47	M932-S47
700 SPORTSMAN 4X4 02-07 (ALL)	M902-S47	M932-S47
700 SPORTSMAN 4X4 X2 08	M902-S47	M902-S47
800 SPORTSMAN EFI/HO 05-08	M902-S47	M932-S47
800 SPORTSMAN TOURING 08-09	M902-S47	M932-S47
800 SPORTSMAN EFI/HO 09-13	M902-S47	1721-1228
800 SPORTSMAN EFI 6X6 10-13	M902-S47	M932-S47
800 SPORTSMAN FOREST 12-13	M902-S47	1721-1228
800 SPORTSMAN FOREST 6X6 12-13	M902-S47	M932-S47
800 RANGER RZR 08-11	1721-0836	M902-S47
800 RANGER RZR-4 EFI/EPS 10-13	1721-1229	1721-1230
800 RANGER RZR EFI/EPS	1721-0836	M902-S47
800 RANGER RZR S/EFI/INTL 12-13	1721-0836	M902-S47
800 RANGER XP 12-13	1721-1229	1721-1230
800 RANGER 4X4 EFI 10-11	1721-1229	1721-1230
800 RANGER 6X6 EFI 10-12	1721-1229	1721-1229
850 SPORTSMAN XP/XP EPS/INTL 10-13	1721-1228	1721-1228
850 SPORTSMAN FOREST 11-12	1721-1228	1721-1228
850 SPORTSMAN TOURING EPS 10-13	1721-1228	1721-1228
850 SPORTSMAN X2 2011	1721-1228	1721-1228
900 RANGER DIESEL 12-13	1721-1229	1721-1230
900 RANGER RZR XP 12-13	1721-1229	1721-1230
SUZUKI		
ALT125 83	-	M9133
ALT125 84-86	-	M9133
LTI25 84-87	-	M9133
LTI60 89-92/03-04	M9155	M9133
LT-F160 91-01/04	M9155	M9133
ALT185F 85	-	M9133
LTI85 84-87	-	M9133
LT230G 85-87	M9156	M9133
LT230E 86-93	M821-S47	M811-S47
LT230GE 85-86	M9156	M9133
LT230S 85-88	M821-S47	M811-S47
LT-F230 86-87	M9156	M9133

FITS MODEL	FRONT PART #	REAR PART #
BRAKE PADS & SHOES (CON'T)		
SUZUKI (CON'T)		
LT-F250 QUAD RUNNER 88-02	M9158	M9159
LT250EFF/EFB 85-86	M9156	M9187
LT250SK/SL 89-90	M821-S47	M811-S47
LT-F250 OZARK 02-13	M107-S47	1723-0141
LT-F300 KING QUAD 91-01	M9160	M9157
LT-F300 KING QUAD 02-03 (RH)	M412-S47	M9157
LT-F300 KING QUAD 02-03 (LH)	M411-S47	-
LT300 E 87-89	M9156	M9187
LT-4WD 87-92	M9158	M9159
LT-4WDX 91-98	M9160	M9157
LT-A/LT-F400 EIGER 02-07	M107-S47	1723-0135
400 KING QUAD ASI/FSI 08-12 (RH)	M919-S47	1723-0135
400 KING QUAD ASI/FSI 08-12 (LH)	M920-S47	-
KING QUAD 450 07-10 (RH)	M919-S47	-
KING QUAD 450 07-10 (LH)	M920-S47	-
LT-A500 X KING QUAD 09-13 (LH)	M920-S47	-
LT-A500 X KING QUAD 09-13 (RH)	M919-S47	-
LT-A500 VINSON 4WD 02	M107-S47	M919-S47
LT-A500 VINSON 4WD 03-07	M107-S47	M310-S47
LT-F500 QUADRUNNER 98-02 (RH)	M412-S47	M9187
LT-F500 QUADRUNNER 98-02 (LH)	M411-S47	-
LT-F500 VINSON 03-08 (ALL)	M811-S47	M310-S47
LT-A700 KING QUAD 05-07 (LH)	M920-S47	-
LT-A700 KING QUAD 05-07 (RH)	M919-S47	-
LT-V700 TWIN PEAKS 04-05 (LH)	M326-S47	-
LT-V700 TWIN PEAKS 04-05 (RH)	M929-S47	-
LT-A750 KING QUAD 08-13 (LH)	M920-S47	-
LT-A750 KING QUAD 08-13(RH)	M919-S47	-
YAMAHA		
YFM80 92-01	M9111	1723-0018
YFM80T GRIZZLY 05-08	M9111	1723-0018
YFM100 89-91	M9111	-
YFAI 100 BREEZE 89-91	M9111	-
YFAI25 BREEZE 89-95	M9111	1723-0018
YT125 80-81	-	M841-S47
YT125 82-85	-	M841-S47
YFM125 BREEZE 92-02	M9111	1723-0018
YFM125 GRIZZLY 04-10	M9111	1723-0018
YT175 TRI-MOTO 82-83	M9111	M841-S47
YFM200 MOTO 4 85-89	M9111	M841-S47
YTM200 TRI-MOTO 83-85	M9111	M841-S47
YTM225 TRI-MOTO 83-86	M9111	M841-S47
YFM225 MOTO 4 86-88	M9111	M841-S47
YFB250 TIMBERWOLF 2WD 92-94	M9111	M9152
YFB250 TIMBERWOLF 2WD 95-98	M9152	M9152
YFB250 TIMBERWOLF 4WD 94-96	M9152	M9152
YFM250 89-91	M9127	M841-S47
YFM250 BEAR TRACKER 99-00	M9152	M9152
YFM250 BEAR TRACKER 01-04	M107-S47	M9152
YFM250 BRUIIN 05-06	M107-S47	1723-0155
YFM250 BIG BEAR 07-09	M107-S47	1723-0155
YFM 250 2012 (RH)	1721-0750	M811-S47
YFM 250 2012 (LH)	1721-0749	-
YT2250 TRI-Z 85-86	M406-S47	M406-S47
YFM300 GRIZZLY 12-13	M312-S47	M310-S47
YFM350ER 87-88	M9111	M841-S47
YFM350ER 89-90/92-95	M9127	M841-S47
YFM350 BIG BEAR 87-88	M9164	M841-S47
YFM350 BIG BEAR 89-95	M9165	M841-S47
YFM350 BIG BEAR 96-98	M9165	M9152
YFM350 BIG BEAR 99	M107-S47	M9152
YFM350 BRUIIN 2X4/4X4 04-06	M107-S47	-
YFM350FX WOLVERINE 4WD 95-05	M107-S47	M811-S47
YFM350V WOLVERINE 2WD 06-09	M107-S47	1723-0155
YFM350 GRIZZLY 2X4/4X4 AUTO 07-10	M107-S47	1723-0155
YFM350 GRIZZLY 4X4 IRS 07-10	M107-S47	1723-0155
YFM350 GRIZZLY 2WD/4WD/IRS 4WD 11-13	M811-S47	-
YFM 350 12-13	M811-S47	1723-0155
YFP350U TERRAPRO 88	M9127	-
YFUIW/TW PRO HAULER 89	M9127	-
YFM400 KODIAK 93-98	M9165	M9132
YFM400 KODIAK 00-02	M107-S47	M327-S47
YFM400 BIG BEAR 00-04 (ALL)	M107-S47	M9132
YFM 400 BIG BEAR 4WD 05-10	M107-S47	-
YFM 400 BIG BEAR 4WD 11-12	M811-S47	-

CONTINUED ON NEXT PAGE

FITS MODEL	FRONT PART #	REAR PART #
BRAKE PADS & SHOES (CON'T)		
YAMAHA (CON'T)		
YFM400F BIG BEAR 4X4/KODIAK AUTO 05-06	M107-S47	M327-S47
YFM400 GRIZZLY 4X4 07-08	M107-S47	M327-S47
YFM400 GRIZZLY 4X4 IRS 07-08	M107-S47	M327-S47
YFM400FWL KODIAK 00-02	M107-S47	M327-S47
YFM400 KODIAK 2X4/4X4 03-04	M107-S47	-
YFM400 KODIAK 05	M107-S47	M327-S47
YFM450 KODIAK 03-06	M107-S47	M327-S47
YFM 450 KODIAK IRS 06	M107-S47	M327-S47
YFM450 WOLVERINE 06-10	M107-S47	M327-S47
YFM450 GRIZZLY 4X4 07-10	M107-S47	M327-S47
YFM450 GRIZZLY 4X4 IRS 09-10	M107-S47	-
YFM450 GRIZZLY 4WD/EPS 11-12	M811-S47	-
YXR450 RHINO 06-09 (RH)	M411-S47	1721-0837
YXR450 RHINO 06-09 (LH)	M412-S47	-
YFM550 GRIZZLY 09-13 (RH)	1721-0750	1721-0752
YFM550 GRIZZLY 09-13 (LH)	1721-0749	1721-0751
YFM600 GRIZZLY 98-01 (ALL)	M811-S47	-
YFM660F GRIZZLY 02-08 (ALL)	M811-S47	M930-S47
YXR660 RHINO 4X4 04-07 (RH)	M411-S47	1721-0837
YXR660 RHINO 4X4 04-07 (LH)	M412-S47	-
YXR700 RHINO 4X4 08-12 (RH)	M411-S47	1721-0837
YXR700 RHINO 4X4 08-12 (LH)	M412-S47	-
YFM700 GRIZZLY 07-13 (RH)	1721-0750	1721-0751
YFM700 GRIZZLY 07-13 (LH)	1721-0749	1721-0752



BRAKE DRUM SEALS > \$10.95-\$45.95

Direct replacements of the original seal. Imported.

FITS MODEL	FRONT PART #	REAR PART #
BRAKE DRUM SEALS		
HONDA		
TRX90 93-13	-	A30-7601
TRX200, TRX200D 90-91	-	A30-7601
TRX200, TRX200D 96-97	-	A30-7601
TRX200D 92-95	-	A30-7601
TRX200SX 87	-	A30-7601
ATC250ES 85-87	-	A30-6701
ATC250SX 85-87	-	A30-6701
TRX250 FOURTRAX 85-87	-	A30-6701
TRX300 FOURTRAX 88-00	1730-0003	A30-7601
TRX300FW FOURTRAX 4X4 88-00	1730-0006	A30-7601
TRX350D 87	-	A30-6701
TRX350D 88-89	1730-0006	A30-6701
TRX350FE 00-06	1730-0009	A30-7602
TRX350FM FOURTRAX RANCHER 00-06	1730-0009	A30-7602
TRX350TE 00-06	1730-0009	A30-7602
TRX350TM RANCHER 00-06	1730-0009	A30-7602
TRX400FA 04-07	1730-0009	A30-7602
TRX400FGA FOURTRAX RANCHER 4X4 04-07	1730-0009	A30-7602
TRX400FW FOURTRAX FOREMAN 4X4 95-01	1730-0006	A30-7602
TRX400FW FOURTRAX FOREMAN 4X4 02-03	1730-0009	A30-7602
TRX450ES 98-01	1730-0006	A30-7602
TRX450FE/FM 02-04	1730-0009	A30-7602
TRX450S 98-01	1730-0006	A30-7602
TRX500FA 01-04	1730-0009	A30-7602
TRX500FA 05-13	-	A30-7602
TRX500FE 05-11	-	A30-7602
TRX500FGA 04	1730-0009	A30-7602
TRX500FGA 05-09	-	A30-7602
TRX500FM 05-11	-	A30-7602
TRX500FPA 09-13	-	A30-7602
TRX500FPE 08-11	-	A30-7602
TRX500FPM 08-11	-	A30-7602
TRX500TM 05-06	-	A30-7602
TRX650 RINCON 03-05	1730-0009	-

FITS MODEL	FRONT PART #	REAR PART #
BRAKE DRUM SEALS (CON'T)		
KAWASAKI		
KLF220 BAYOU 88-02	-	1730-0005
KLF250 BAYOU 03-11	-	1730-0005
KLF300A BAYOU 86-87	-	1730-0005
KLF300B BAYOU 88-04	-	1730-0005
KLF300C BAYOU 4X4 89-04	-	1730-0010
KLF400 BAYOU 93-99	-	1730-0010
SUZUKI		
LT-4WD 250 87-88	-	1730-0007
LT-4WD 250 89-98	1730-0004	1730-0007
LT-F250 88-01	1730-0004	1730-0007
LT-F4WD 250 97-98	1730-0004	1730-0007
LT-F300F KING QUAD 99-02	1730-0008	1730-0001
LT-F4WDX KING QUAD 300 91-94	-	1730-0001
LT-F4WDX KING QUAD 300 95-98	1730-0008	1730-0001
LT-A400 2WD KING QUAD 08-09	-	1730-0002
LT-A400 EIGER 02-07	-	1730-0002
LT-A400F 4WD KING QUAD 08-12	-	1730-0002
LT-A500F QUAD MASTER AUTO 00-01	-	1730-0001
LT-F500F QUAD MASTER 00-01	-	1730-0001
LT-F500F QUAD RUNNER 98-99	-	1730-0001
LT-F500F VINSON 02	-	1730-0001
YAMAHA		
YFB250 TIMBERWOLF 92-94	-	A30-19401
YFB250 TIMBERWOLF 95-98	A30-19401	A30-19401
YFB250FW TIMBERWOLF 94-00	A30-19401	A30-19401
YFM250 BEARTRACKER 99-04	A30-19401	A30-19401
YFM250 MOTO-4 89-91	A30-19401	-
YFM350ER MOTO-4 90-95	A30-19401	-
YFM350FW BIG BEAR 89-95	A30-19401	-
YFM350FW BIG BEAR 96-98	A30-19401	A30-19401
YFM350FW BIG BEAR 99	-	A30-19401
YFM350U BIG BEAR 96-98	A30-19401	A30-19401
YFM350U BIG BEAR 99	-	A30-19401
YFM400 KODIAK 4WD 93-98	A30-19401	A30-19401
YFM400 KODIAK 4WD 99	-	A30-19401
YFM600 GRIZZLY 98-01	-	A30-19401



M.U.D.





- PROMO
- GARAGE
- TOWING
- RIDER
- NRA BY MOOSE
- ENGINE
- SUSPENSION & DRIVE**
- WHEELS & TIRES
- ELECTRICAL
- CONTROLS
- BODY
- LUGGAGE
- RACKS
- UTV
- WINCHES
- PLOWS

BRAKE CALIPER REBUILD KITS > \$13.95-\$37.95

Each kit includes all necessary rubber components and pad hanger pins if applicable. Imported.



FITS MODEL	FRONT KIT PART #
FRONT BRAKE CALIPER REBUILD KITS	
HONDA	
TRX420 07-12	1702-0065
FOREMAN 500 05-11	1702-0067
RUBICON 500 05-12	1702-0067
TRX680 06-12	1702-0067
KAWASAKI	
KVF300/4X4 99-02	1702-0072
KVF360/4X4 03-12	1702-0072
KLF400 93-99	1702-0071
KVF400/4X4 97-02	1702-0072
KVF650 06-09	1702-0071
KVF750 05-12	1702-0071
SUZUKI	
LTF250 02-09	1702-0073
LTA400/F 02-07	1702-0073
LTF400/F 02-07	1702-0073
LTA400/F 08	1702-0074
LTF400/F 08	1702-0074
LTA450X 07-08	1702-0074
LTA500F 02-07	1702-0073
LTF500F 03-07	1702-0073
LTA500F 00-01	1702-0075
LTF500F 98-02	1702-0075
LTA700X 06-07	1702-0074
LTA750X 08	1702-0074
YAMAHA	
YFM250B 05-09	1702-0076
YFM250X 01-04	1702-0076
YFM250R 08-12	1702-0077
YFM350 BRUIN 04-06	1702-0076
YFM350F/U 99	1702-0076
YFM350FG/G 07-12	1702-0076
YFM350R 04-12	1702-0076
YFM350X 89-04	1702-0076
YFM350X 06-09	1702-0076
YFM400/F 00-12	1702-0076
YFM400A/FA 99-06	1702-0076
YFM450FA 03-06	1702-0076
YFM450FG 07-12	1702-0076
YFM450FX 06-10	1702-0076
YFM500FG 09	1702-0077
YFM550FG 09-12	1702-0077
YFM660R 01-05	1702-0076
YFM700FG 07-12	1702-0077
YFM700R 06-12	1702-0078

FITS MODEL	REAR KIT PART #
REAR BRAKE CALIPER REBUILD KITS	
HONDA	
TRX650FA 03-05	1702-0088
TRX680FA 06-12	1702-0088
YAMAHA	
YFM250R 08-09	1702-0081
YFM250R 10-12	1702-0080
YFM350R 04-09	1702-0081
YFM350FX 95-05	1702-0082
YFM350X 87-04	1702-0082
YFM400A 00-01	1702-0083
YFM400FA 00-06	1702-0083
YFM450FA 03-06	1702-0083
YFM450FG 07	1702-0083
YFM450FX 06-09	1702-0083
YFM500FG 09	1702-0084
YFM550FG 09-12	1702-0084
YFM660R 01-05	1702-0080
YFM660F 02-08	1702-0085
YFM700FG 07-12	1702-0084
YFM700R 06-12	1702-0086

BRAKE CALIPER PISTONS > \$18.95-\$72.95

Kit includes required quantities of brake caliper pistons. Imported.



FITS MODEL	FRONT PART #	QTY
FRONT BRAKE CALIPER PISTONS		
HONDA		
TRX420 07-09	1702-0184	1
TRX500 05-09	1702-0186	1
TRX680 06-09	1702-0186	1
KAWASAKI		
KVF300/4X4 99-02	1702-0189	1
KVF360/4X4 03-09	1702-0189	1
KVF400/4X4 97-02	1702-0189	1
KLF400 93-99	1702-0183	2
KVF650 06-09	1702-0183	2
KVF750 05-09	1702-0183	2
SUZUKI		
LT-F250 02-09	1702-0187	1
LT-F300F 99-02	1702-0185	2
LT-A400/F 02-07	1702-0187	1
LT-F400/F 02-07	1702-0187	1
LT-A400/F & LT-F400/F 08-09	1702-0188	1
LT-A450X 07-09	1702-0188	1
LT-A500F 00-01	1702-0183	2
LT-F500 98-02	1702-0183	2
LT-A500F 02-07	1702-0187	1
LT-F500F 03-07	1702-0187	1
LT-A500XP 09	1702-0188	1
LT-A700X 06-07	1702-0188	1
LT-A750X 08-09	1702-0188	1
YAMAHA		
YFM250R 08-09	1702-0188	1
YFM250B 05-09	1702-0187	1
YFM250X 01-04	1702-0187	1
YFM350A/FA 04-06	1702-0187	1
YFM350B 05-06	1702-0187	1
YFM350F/U 99	1702-0187	1
YFM350FG/G 07-09	1702-0187	1
YFM350FX 95-05	1702-0187	1
YFM350R 04-09	1702-0187	1
YFM350X 89-04	1702-0187	1
YFM350X 06-09	1702-0187	1
YFM400 & YFM400A 00-04	1702-0187	1
YFM400F 00-09	1702-0187	1
YFM400FA 99-06	1702-0187	1
YFM450FA 03-06	1702-0187	1
YFM450FG 07-09	1702-0187	1
YFM450FX 06-09	1702-0187	1
YFM500FG 09	1702-0188	1
YFM600 98-01	1702-0187	1
YFM660F 02-08	1702-0187	1
YFM700R 06-09	1702-0185	2
YFM700FG 07-09	1702-0188	1

FITS MODEL	REAR PART #	QTY
REAR BRAKE CALIPER PISTONS		
KAWASAKI		
KSF250 87-04	1702-0192	1
KXF250 87-88	1702-0192	1
KXT250 87	1702-0192	1
KEF300 95-03	1702-0192	1
KSF450 08-09	1702-0192	1
SUZUKI		
LT-A500F 02-03	1702-0193	1
YAMAHA		
YFM250R 08-09	1702-0190	1
YFM400A 00-01	1702-0193	1
YFM400FA 00-06	1702-0193	1
YFM450FA 03-06	1702-0193	1
YFM450FG 07	1702-0193	1
YFM450FX 06-09	1702-0193	1
YFM500FG 09	1702-0195	1
YFM660F 02-08	1702-0196	2
YFM660R 01-05	1702-0190	1
YFM700FG 07-09	1702-0195	1
YFM700R 06-09	1702-0197	1



BRAKE CALIPER PINS > \$5.95-\$16.95

Each kit includes required quantities of brake pad hanger pins. Imported.

FITS MODEL	FRONT KIT PART #
FRONT BRAKE CALIPER PINS	
HONDA	
TRX420 07-12	1702-0106
KAWASAKI	
KVF300/4X4 99-02	1702-0108
KVF360/4X4 03-12	1702-0108
KVF400/4X4 97-02	1702-0108
KLF400 93-99	1702-0106
KVF650 06-09	1702-0106
KVF750 05-12	1702-0106
SUZUKI	
LTF250 02-09	1702-0106
LTA400/F 02-07	1702-0106
LTF400/F 02-07	1702-0106
LTA400/F 08	1702-0109
LTF400/F 08	1702-0109
LTA450X 07-08	1702-0109
LTA500F 00-07	1702-0106
LTF500F 98-02	1702-0106
LTA700X 06-07	1702-0109
LTA750X 08	1702-0109
YAMAHA	
YFM250B 05-09	1702-0106
YFM250R 08-12	1702-0107
YFM250X 01-04	1702-0106
YFM350 BRUIN 04-06	1702-0106
YFM350F/U 99	1702-0106
YFM350FG/G 07-12	1702-0106
YFM350FX 95-05	1702-0106
YFM350R 04-12	1702-0106
YFM400/F 00-12	1702-0106
YFM400A/FA 99-06	1702-0106
YFM450FA 03-06	1702-0106
YFM450FG 07-12	1702-0106
YFM450FX 06-10	1702-0106
YFM500FG 09	1702-0107
YFM600 98-01	1702-0106
YFM660F 02-08	1702-0106
YFM660R 01-05	1702-0106
YFM700FG 07-09	1702-0107
YFM700R 06-09	1702-0109

FITS MODEL	REAR KIT PART #
REAR BRAKE CALIPER PINS	
KAWASAKI	
KSF250 87-04	1702-0108
KEF300 95-03	1702-0108
KSF450 08-09	1702-0108
YAMAHA	
YFS200 04-06	1702-0108
YFM250R 08-09	1702-0108
YFM400A 00-01	1702-0110
YFM400FA 00-06	1702-0110
YFM450FA 03-06	1702-0110
YFM450FG 07	1702-0110
YFM450FX 06-09	1702-0110
YFM660R 01-05	1702-0108
YFM660F 02-08	1702-0111
YFM700R 06-09	1702-0111



MASTER CYLINDER REPAIR KITS > \$13.95-\$34.95
 Complete kits to rebuild the master cylinders.
 Each kit contains all necessary components.
 Imported.

FITS MODEL	FRONT PART #	REAR PART #
MASTER CYLINDER REPAIR KITS		
HONDA		
TRX200 FOURTRAX 84	MD06-001	-
TRX200 FOURTRAX 90-91	MD06-001	-
TRX200D FOURTRAX 91-97	MD06-001	-
TRX200SX FOURTRAX 86-88	MD06-001	-
TRX250 FOURTRAX 85-86	MD06-001	-
TRX250 RECON 97-08	MD06-001	-
TRX300 FOURTRAX 88-99	MD06-001	-
TRX300 FOURTRAX 00	MD06-003	-
TRX300FW FOURTRAX 88-00	MD06-003	-
TRX350 RANCHER 00-03	MD06-001	-
TRX350 RANCHER 4X4 00-03	MD06-001	-
TRX350/D FOURTRAX 86-87	MD06-001	-
TRX350 04-06	0617-0090	-
TRX400FW FOREMAN 95-03	MD06-003	-
TRX400 04-07	0617-0090	-
TRX420 07-08	0617-0090	-
TRX450 FOREMAN 98-01	MD06-003	-
TRX500 01-03	MD06-003	-
TRX500FA/FGA 04	MD06-003	-
TRX500 05-08	0617-0090	-
TRX500FA/FGA 05-08	0617-0090	-
TRX650 03-05	0617-0090	0617-0093
TRX680 06-07	0617-0090	0617-0093
KAWASAKI		
KVF300 PRAIRIE 4X4 99-02	MD06-101	-
KVF300 PRAIRIE 99-02	MD06-101	-
KLF300 BAYOU 4X4 89-04	MD06-101	-
KLF300 BAYOU 86-04	MD06-101	-
KEF300 LAKOTA 95-03	MD06-101	MD06-151
KVF360 03-09	MD06-101	-
KVF400/4X4 PRAIRIE 97-02	MD06-101	-
KLF400 BAYOU 93-99	MD06-101	-
KVF650 PRAIRIE 02-03	MD06-101	-
KVF650D/E 05-09	MD06-101	-
KVF650F/H 07-09	0617-0091	-
KSV700 04-09	MD06-101	-
KVF700 PRAIRIE 04-06	MD06-101	-
KVF750 05-09	0617-0091	-
SUZUKI		
LT230E QUADRUNNER 87-93	MD06-201	MD06-251
LT230GE QUADRUNNER 85-86	MD06-201	-
LTF230 QUADRUNNER 86-87	MD06-201	-
LT250E/EF QUADRUNNER 85-86	MD06-202	-
LTF250 OZARK 03-08	MD06-202	-
LTF250F QUADRUNNER 88-02	MD06-202	-
LT300E QUADRUNNER 87-89	MD06-201	-
LTF300F KING QUAD 99-02	MD06-202	-
LT4WD QUADRUNNER 87	MD06-201	-
LT4WD QUADRUNNER 88-96	MD06-202	-
LTF4WD QUADRUNNER 97-98	MD06-202	-
LTF4WDX KING QUAD 91-98	MD06-202	-
LTA400/F 02-08	MD06-202	-
LTF400/F 02-08	MD06-202	-
LTA450X 07-08	MD06-202	-
LTA500F 06-07	-	0617-0094
LTA500F QUAD MASTER 00-01	MD06-202	-
LTA500F VINSON 02-07	MD06-202	-
LTF500F 03-07	-	0617-0094
LTF500F QUADRUNNER 98-07	MD06-202	-
LTA700X 05-07	MD06-202	-
LTA750X 08	MD06-202	-
YAMAHA		
YFM250B 05-08	0617-0092	-
YFM250X 02-04	0617-0092	-
YFM250R 08-12	-	0617-0042
YFM350/FW BIG BEAR 87-98	MD06-301	-

FITS MODEL	FRONT PART #	REAR PART #
MASTER CYLINDER REPAIR KITS (CON'T)		
YAMAHA (CON'T)		
YFM350A/G 04-08	0617-0092	-
YFM350F/U BIG BEAR 99	MD06-302	-
YFM350FA/FG 04-08	0617-0092	-
YFM350FX 02-05	0617-0092	-
YFM350R 04-08	0617-0041	0617-0095
YFM350U BIG BEAR 96-98	MD06-301	-
YFM350X 02-04	0617-0041	-
YFM350X 06-08	0617-0092	-
YFM400 BIG BEAR 00-01	MD06-301	-
YFM400A 03-04	0617-0092	-
YFM400F 02-08	0617-0092	-
YFM400F 99	MD06-302	-
YFM400F/FW KODIAK 93-99	MD06-301	-
YFM400FA 02-06	0617-0092	-
YFM450FA/FG 03-08	0617-0092	-
YFM450FX 06-08	0617-0092	-
YFM600 GRIZZLY 98-01	MD06-302	-
YFM660F 02-08	0617-0092	-
YFM700FG 07	0617-0041	-



OEM REPLACEMENT ROTORS > \$99.95
 High-strength, low-carbon aircraft quality steel rotors offer greater friction and longer life than OEM rotors. CAD/CAM laser-cut and finish-ground for a distortion-free flat profile. Bright zinc plating to prevent corrosion. Made in the USA.

FITS MODEL	FRONT PART #	REAR PART #
OEM REPLACEMENT ROTORS		
ARCTIC CAT		
TRX650 RINCON 03-05	-	1711-0443
TRX680 RINCON 06-13	-	1711-0443
KAWASAKI		
KVF360 PRAIRIE 03-13	1711-0444	-
KVF650 PRAIRIE 02-07	1711-0444	-
KVF700 PRAIRIE 04-06	1711-0444	-
KVF 700 BRUTE FORCE 04-05	1711-0444	-
KVF750 BRUTE FORCE 05-13	1711-0444	-
TERYX 750 08-10	1711-0444	-
POLARIS		
250 2X4/4X4 90	MO61-1502	-
BIG BOSS 250 6X6 91	MO61-1502	-
MAGNUM 325 2X4/4X4 00	MO61-1502	-
MAGNUM 330 2X4 HDS 03-06	MO61-1502	-
SPORTSMAN/WORKER 335		
4X4 99-00	MO61-1502	-
350L 4X4 90	MO61-1502	-
BIG BOSS/ SPORTSMAN 350L 93	MO61-1502	-
400L 4X4 94	MO61-1502	-
BIG BOSS 400L 6X6 94-97	MO61-1502	-
SPORTSMAN 400 94-05	MO61-1502	-
XPLORER 400L 4X4 95-98	MO61-1502	-
XPLORER 400L 99-00	MO61-1502	-
XPLORER 400 01-02	MO61-1502	-
MAGNUM 425 4X4/6X6 95-98	MO61-1502	-
XPEDITION 425 4X4 00	MO61-1502	-
DIESEL 455 99-01	MO61-1502	-
BIG BOSS 500 6X6 98-99	MO61-1502	-
MAGNUM 500 99-01	MO61-1502	-

FITS MODEL	FRONT PART #	REAR PART #
OEM REPLACEMENT ROTORS (CON'T)		
POLARIS (CON'T)		
SPORTSMAN/WORKER 500		
4X4 97-02	MO61-1502	-
SPORTSMAN 500 6X6 00-08	MO61-1502	-
XPLORER 500 4X4 97	MO61-1502	-
SPORTSMAN 450 07	-	1711-0849
SPORTSMAN 500 EFI 07-13	-	1711-0849
SPORTSMAN 500 X2 06-08	-	1711-0849
SPORTSMAN 500 XP 09	1711-0847	1711-0847
SPORTSMAN 550 X2 10-13	1711-0847	1711-0847
SPORTSMAN 550 XP EPS 09-13	1711-0847	1711-0847
SPORTSMAN 700 EFI 07	-	1711-0849
SPORTSMAN 700 X2 08	-	1711-0849
SPORTSMAN 800 EFI 6X6	-	1711-0849
BIG BOSS 09-13	-	1711-0849
SPORTSMAN 800	-	1711-0849
TOURING/EFI 07-13	-	1711-0849
SPORTSMAN 800 X2 EFI 07-09	-	1711-0849
SPORTSMAN 850 XP 09-13	1711-0847	1711-0847
SPORTSMAN 850 XP EPS 09-13	1711-0847	1711-0847
SPORTSMAN TOURING 500 08-12	-	1711-0849
RANGER 400 HO 10-13	-	1711-0849
RANGER 500 2X4/4X4	-	1711-0849
EFI/CREW 06-13	-	1711-0849
RANGER 700 4X4 EFI/LE 07	-	1711-0849
RANGER 700 6X4 EFI 08	-	1711-0849
RANGER 700 6X6 EFI 06-09	-	1711-0849
RANGER 700 CREW EFI 4X4 09	-	1711-0849
RANGER 700 EFI 4X4 09	1711-0846	1711-0849
RANGER 700 XP 4X4 06-08	-	1711-0849
RANGER 800 CREW		
(RGR 4X4) 10-12	1711-0846	1711-0849
RANGER 800 HD/XP/6X6 10-13	1711-0846	1711-0849
RANGER 800 RZR 08-13	1711-0848	1711-0849
RANGER 800 RZR S EFI 09-13	1711-0848	1711-0849
RANGER 800 RZR-4 10-13	1711-0846	1711-0849
RANGER 900 D 4X4 DIESEL 11-13	1711-0846	1711-0849
RANGER EV ELECTRIC 10-13	-	1711-0849
RANGER TM 06	-	1711-0849
SUZUKI		
LT-V700 TWIN PEAKS 4X4 04-05	1711-0444	-
YAMAHA		
YFM250 BEAR TRACKER 01-04 (LEFT)	MO61-1409L	-
YFM250 BEAR TRACKER 01-04 (RIGHT)	MO61-1409R	-
YFM350 WOLVERINE 95-05	-	MO61-1400
YFM350 BIG BEAR 99	-	MO61-1400
YXR450 RHINO 4X4 06-08	1711-0445	1711-0446
YFM660 RAPTOR 01-05 (LEFT)	MO61-1409L	MO61-1410
YFM660 RAPTOR 01-05 (RIGHT)	MO61-1409R	-
RHINO 660 04-08	1711-0445	1711-0446
RHINO 700 08-13	1711-0445	1711-0843
YFM550 GRIZZLY 4WD/EPS		
AUTO 09-13	1711-0844	1711-0845
YFM700 GRIZZLY	-	1711-0845
AUTO/4X4/EPS 07-12	1711-0844	1711-0845

PLOWS
 WINCHES
 UTV
 RACKS
 LUGGAGE
 BODY
 CONTROLS
 ELECTRICAL
 WHEELS & TIRES
 SUSPENSION & DRIVE
 ENGINE
 NRA BY MOOSE
 RIDER
 TOWING
 GARAGE
 PROMO



POLARIS

STARTER DRIVES > \$92.95

Replaces OEM starter drive. Imported.

FITS MODEL	PART #
POLARIS STARTER DRIVES	
POLARIS	
250 2X4 93	2110-0407
250 4X4 93	2110-0407
250 6X6 93	2110-0407
BIG BOSS 250 89	2110-0407
BIG BOSS 250 4X6 89-92	2110-0407
BIG BOSS 250 6X6 91-92	2110-0407
CYCLONE 250 87	2110-0407
TRAIL BLAZER 250 90-06	2110-0407
TRAIL BOSS 250 85-99	2110-0407
TRAIL BOSS 250 2X4 88-92	2110-0407
TRAIL BOSS 250 4X4 87-93	2110-0407
TRAIL BOSS 250R/ES 88	2110-0407
XPLORER 250 01	2110-0407
300 2X4 & 4X4 94-95	2110-0407
TRAIL BOSS 300 2X4 & 4X4 95	2110-0407
XPLORER 300 97-00	2110-0407
XPLORER 300 4X4 95-00	2110-0407
XPRESS 300 96-99	2110-0407
MAGNUM 325 2X4 00-02	2110-0407
MAGNUM 325 4X4 00-02	2110-0407
TRAIL BOSS 325 00-01	2110-0407
XPEDITION 325 00-02	2110-0407
ATP330 4X4 04-05	2110-0407
MAGNUM 330 2X4 03-05	2110-0407
MAGNUM 330 4X4 03-06	2110-0407
MAGNUM 330 HDS 03	2110-0407
TRAIL BLAZER 330 09-10	2110-0407
TRAIL BOSS 330 04-06	2110-0407
SPORTSMAN 335 99-00	2110-0407
WORKER 335 99	2110-0407
350L 2X4 & 4X4 93	2110-0407
TRAIL BOSS 350L 2X4 91-92	2110-0407
TRAIL BOSS 350L 4X4 91-92	2110-0407
BIG BOSS 400L 6X6 95-97	2110-0407
RANGER 400 4X4 10	2110-0407
SPORTSMAN 400 94-05	2110-0407
XPLORER 400 98-02	2110-0407
XPLORER 400 4X4 95	2110-0407
XPLORER 400L 96-97	2110-0407
XPRESS 400L 96-97	2110-0407
MAGNUM 425 2X4 95-98	2110-0407
MAGNUM 425 4X4 96-97	2110-0407
RANGER 425 2X4 04	2110-0407
XPEDITION 425 00-02	2110-0407
SPORTSMAN 450 06-07	2110-0407
ATP 500 4X4 04	2110-0407
BIG BOSS 500 6X6 98-99	2110-0407
MAGNUM 500 99-01	2110-0407
MAGNUM 500 4X4 97-03	2110-0407
SPORTSMAN 500 4X4 96-03	2110-0407
SPORTSMAN 500 6X6 99-04	2110-0407
SPORTSMAN 500 EFI TRACTOR 10	2110-0407
SPORTSMAN 500 HO EFI 4X4 06-09	2110-0407
SPORTSMAN 500 NON-EFI 4X4 04	2110-0407
SPORTSMAN 500 NON-EFI HO 05-06	2110-0407
SPORTSMAN 500X2 2-UP 06-08	2110-0407
WORKER 500 98-02	2110-0407
XPLORER 500 97-01	2110-0407
RANGER 500 99	2110-0407
RANGER 500 2X4 03	2110-0407
RANGER 500 2X4 07-08	2110-0407
RANGER 500 4X4 03-04	2110-0407
RANGER 500 4X4 06-07	2110-0407
RANGER 500 4X4 EFI 06-09	2110-0407
RANGER 500 6X6 03-05	2110-0407



CAN-AM

STARTER DRIVES > \$199.95

Replaces OEM starter drive. Imported.

FITS MODEL	PART #
CAN-AM STARTER DRIVES	
CAN-AM	
OUTLANDER 330 XT 4X4 05	2110-0443
OUTLANDER 330 STD 2X4 04-05	2110-0443
OUTLANDER 330 STD 4X4 04-05	2110-0443
OUTLANDER 400 2X4 03-05	2110-0443
OUTLANDER 400 4X4 04	2110-0443
OUTLANDER 400 XT 4X4 04-08	2110-0443
OUTLANDER 400 STD 4X4 05-08	2110-0443
OUTLANDER 400 MAX 04-05	2110-0443
OUTLANDER 400 MAX STD 4X4 06-08	2110-0443
OUTLANDER 400 MAX XT 4X4 06-08	2110-0443
OUTLANDER 400 EFI STD 08-12	2110-0443
OUTLANDER 400 EFI XT 08-12	2110-0443
OUTLANDER 400 EFI MAX STD 08-12	2110-0443
OUTLANDER 400 EFI MAX XT 08-12	2110-0443



HIGH PERFORMANCE DRIVE BELTS > \$69.95

Delivers unparalleled response. Constructed with extra strong p-aramid cord reinforcement and engineered fiber loaded neoprene compound. Delivers the "muscle" and durability demanded by today's high performance engines. Tested under severe field conditions, this belt has been proven to run cooler and provides longer belt life than competitive belts. Made in the USA.

FITS MODEL	PART #
HIGH PERFORMANCE DRIVE BELTS	
ARCTIC CAT	
550 11-12	1142-0414
550 HI EFI 09-10	1142-0414
550 HI EFI LE 09-10	1142-0414
550 LTD 11	1142-0414
550 S 10-11	1142-0414
550 S LTD 10	1142-0414
TRV 550 11	1142-0414
TRV 550 CRUISER 11	1142-0414
TRV 550 GT 11	1142-0414
TRV 550 HI EFI 09-10	1142-0414
TRV 550 HI EFI LE 09	1142-0414
TRV 550 S GT 10	1142-0414
650 4X4 AUTO 04	1142-0245
650 4X4 AUTO LE 04&06	1142-0245
650 HI 10-11	1142-0414
650 HI 4X4 AUTO 05-08	1142-0414
650 HI 4X4 AUTO LE 07	1142-0414
650 HI 4X4 AUTO TRV 07-08	1142-0414
650 HI 4X4 PROWLER & PROWLER XT 07	1142-0414
650 HI 4X4 TBX 07	1142-0414
650 HI 4X4 TRV LE PLUS 07	1142-0414
650 V2 4X4 AUTO 05-06	1142-0245
650 V2 4X4 AUTO LE 05-06	1142-0245
MUD PRO 650 HI 10-11	1142-0414
TBX 650 09	1142-0414
TRV 650 HI 09	1142-0414
700 EFI 4X4 AUTO 06-08	1142-0246
700 EFI 4X4 AUTO LE 07-08	1142-0246
700 EFI 4X4 AUTO TRV LE 08	1142-0246
700 EFI CRUISER 08	1142-0246
700 HI EFI 09-11	1142-0414
700 HI EFI 4X4 AUTO SE 08	1142-0414

FITS MODEL	PART #
HIGH PERFORMANCE DRIVE BELTS (CON'T)	
ARCTIC CAT (CON'T)	
700 HI EFI LE 09-10	1142-0414
700 HI EFI MUD PRO 09	1142-0414
700 HI EFI SE 09	1142-0414
700 LTD 11-12	1142-0414
700 S 10-11	1142-0414
700 S LTD 10	1142-0414
MUD PRO 700 HI EFI 10-13	1142-0414
TBX 700 HI EFI 10	1142-0414
TBX 700 LTD 11	1142-0414
TRV 700 11	1142-0414
TRV 700 CRUISER 11	1142-0414
TRV 700 HI EFI 10	1142-0414
TRV 700 HI EFI CRUISER 09-10	1142-0414
TRV 700 S GT 10	1142-0414
PROWLER 550 HI EFI 09	1142-0414
PROWLER 650 4X4 AUTO 08	1142-0414
PROWLER 650 4X4 AUTO M4 08	1142-0414
PROWLER HDX 700 11-13	1142-0414
PROWLER XT 550 10-11	1142-0414
PROWLER XT 650 HI 09	1142-0414
PROWLER XT 700 HI EFI 09	1142-0414
PROWLER XT 700 10-11	1142-0414
PROWLER XT 700 HI EFI LE 08-09	1142-0414
PROWLER XT 700 HI LE 08-09	1142-0414
PROWLER XT 700 HI EFI 09	1142-0414
CAN-AM	
RENEGADE 500 08	1142-0244
RENEGADE 500 EFI 09-13	1142-0244
OUTLANDER 500 07-08	1142-0244
OUTLANDER 500 EFI 09-13	1142-0244
OUTLANDER 500 EFI XT 09	1142-0244
OUTLANDER 500 XT 07-08	1142-0244
OUTLANDER MAX 500 EFI 09-13	1142-0244
OUTLANDER MAX 500 EFI LTD 09	1142-0244
OUTLANDER MAX 500 EFI XT 09	1142-0244
OUTLANDER 650 HO EFI 06	1142-0244
OUTLANDER 650 HO EXI XT 06	1142-0244
OUTLANDER 650 MAX HO EFI 06	1142-0244
OUTLANDER 650 MAX HO EXI XT 06	1142-0244
OUTLANDER 650 07-08	1142-0244
OUTLANDER 650 EFI 09-11	1142-0244
OUTLANDER 650 EFI XT 09	1142-0244
OUTLANDER 650 HO EFI 08	1142-0244
OUTLANDER 650 XT 07-08	1142-0244
OUTLANDER MAX 650 EFI 09-11	1142-0244
OUTLANDER MAX 650 EFI XT 09	1142-0244
OUTLANDER 800 HO EFI 4X4 06	1142-0244
OUTLANDER MAX 800 HO EFI 06	1142-0244
OUTLANDER 800 HO EFI 08	1142-0244
OUTLANDER 800R EFI 09-12	1142-0244
OUTLANDER 800R EFI XT 09	1142-0244
OUTLANDER MAX 800 07-08	1142-0244
OUTLANDER MAX 800 LTD 07-08	1142-0244
OUTLANDER MAX 800 XT 07-08	1142-0244
OUTLANDER MAX 800R EFI 09-13	1142-0244
OUTLANDER MAX 800R EFI XT 09	1142-0244
OUTLANDER MAX 800R LTD 09-11	1142-0244
RENEGADE 800 07-08	1142-0244
RENEGADE 800 HO EFI 08	1142-0244
RENEGADE 800 X 08	1142-0244
RENEGADE 800R EFI 09-13	1142-0244
RENEGADE 800R EFI X 09	1142-0244
COMMANDER 1000 11-13	1142-0244
COMMANDER 1000 X 11-12	1142-0244
COMMANDER 1000 XT 11-12	1142-0244
COMMANDER 800 R 11-13	1142-0244
COMMANDER 800R XT 11	1142-0244
KAWASAKI	
PRAIRIE 360 04-09	1142-0245
PRAIRIE 360 4X4 04-13	1142-0245
BRUTE FORCE 650 05-08	1142-0245
BRUTE FORCE 650 4X4 05-13	1142-0245
BRUTE FORCE 650 4X4 06-13	1142-0245
PRAIRIE 650 4X4 W/AFTERMARKET CLUTCH 02-03	1142-0245
PRAIRIE 700 4X4 04-06	1142-0245
KFX 700 04-09	1142-0245

CONTINUED ON NEXT PAGE

FITS MODEL	PART #
HIGH PERFORMANCE DRIVE BELTS (CON'T)	
KAWASAKI (CON'T)	
KFX 700 V FORCE 04-05	1142-0245
BRUTE FORCE 750 05-09	1142-0245
BRUTE FORCE 750 4X4 05-11	1142-0245
POLARIS	
TRAIL BLAZER 250 00-05	1142-0239
TRAIL BOSS 325 00-12	1142-0239
ATP 330 04-05	1142-0239
ATP 330 4X4 04-05	1142-0239
ATP 330 4X4 QUAD 05	1142-0239
ATV'S (ALL MODELS) 94-98	1142-0239
ATV'S (NON EBS) 99	1142-0239
MAGNUM 325 2X4 00-02	1142-0239
MAGNUM 325 4X4 00-05	1142-0239
MAGNUM 330 4X4 03-06	1142-0239
TRAIL BLAZER 330 08-13	1142-0239
TRAIL BOSS 330 03-13	1142-0239
SPORTSMAN 335 00	1142-0239
SCRAMBLER 400 2X4 00-02	1142-0239
SCRAMBLER 400 4X4 00 & 02	1142-0239
SPORTSMAN 400 02-05	1142-0239
SPORTSMAN 400 12	1142-0239
SPORTSMAN 400 HO 11	1142-0239
SPORTSMAN 400 HO 4X4 11-13	1142-0239
TRAIL BLAZER 400 03	1142-0239
SPORTSMAN 450 06-07	1142-0239
MAGNUM 500 00&02	1142-0239
MAGNUM 500 W/EBS 00-02	1142-0242
OUTLAW 500 06	1142-0239
SCRAMBLER 500 2X4 01-02	1142-0239
SCRAMBLER 500 4X4 01-12	1142-0239
SCRAMBLER 500 4X4 W/EBS 04-05	1142-0242
SPORTSMAN 500 EFI 06-07	1142-0242
SPORTSMAN 500 EFI 08	1142-0241
SPORTSMAN 500 EFI TOURING 08	1142-0241
SPORTSMAN 500 EFI X2 07-08	1142-0241
SPORTSMAN 500 HO 03-05	1142-0242
SPORTSMAN 500 HO 06	1142-0239
SPORTSMAN 500 HO 08-12	1142-0239
SPORTSMAN 500 HO 13	1142-0241
SPORTSMAN 500 HO EFI 2008	1142-0241
SPORTSMAN 500 HO TOURING 10-12	1142-0241
SPORTSMAN 500 RSE 00	1142-0239
SPORTSMAN TOURING 500 EFI 09	1142-0241
SPORTSMAN TOURING 500 HO 11	1142-0241
X2 500 EFI 07-08	1142-0241
SPORTSMAN 6X6 00-07	1142-0239
SPORTSMAN 6X6 08	1142-0239
SPORTSMAN 600 03-05	1142-0242
SPORTSMAN 600 TWIN W/EBS 03-05	1142-0242
SPORTSMAN 600 W/EBS 04-05	1142-0242
SPORTSMAN 700 02-03	1142-0242
SPORTSMAN 700 05-06	1142-0242
SPORTSMAN 700 EFI 05-06	1142-0242
SPORTSMAN 700 EFI X2 08	1142-0241
SPORTSMAN 700 TWIN EFI W/EBS 04-05	1142-0242
SPORTSMAN 700 TWIN W/EBS 02-05	1142-0242
SPORTSMAN 800 10	1142-0241
SPORTSMAN 800 6X6 10	1142-0241
SPORTSMAN 800 EFI 05-06	1142-0240
SPORTSMAN 800 EFI 08	1142-0241
SPORTSMAN 800 EFI 10-12	1142-0241
SPORTSMAN 800 EFI 6X6 09	1142-0241
SPORTSMAN 800 EFI SCANDINAVIAN 08	1142-0241
SPORTSMAN 800 EFI TOURING 08	1142-0241
SPORTSMAN 800 EFI X2 07-08	1142-0241
SPORTSMAN 800 HO EFI 08-09	1142-0241
SPORTSMAN BIG BOSS 6X6 800 11	1142-0241
SPORTSMAN TOURING 800 EFI 09	1142-0241
X2 800 EFI 07	1142-0241
SPORTSMAN X2 06	1142-0242
SPORTSMAN X2 08	1142-0241
RANGER 700 03	1142-0239
RANGER 700 09	1142-0239
RANGER 425 2X4 04	1142-0239
RANGER 500 2X4 07	1142-0239
RANGER 400 11-13	1142-0239

FITS MODEL	PART #
HIGH PERFORMANCE DRIVE BELTS (CON'T)	
POLARIS (CON'T)	
RANGER 400 4X4 04-05	1142-0239
RANGER 500 4X4 07	1142-0239
RANGER 500 EFI 11-13	1142-0241
RANGER 700 4X4 07-09	1142-0240
RANGER 700 HD 4X4 09	1142-0240
RANGER 6X6 04-05	1142-0239
RANGER 6X6 07-08	1142-0240
RANGER CREW 500 EFI 11	1142-0241
RANGER 700 HD 09	1142-0240
RZR 08-09	1142-0241
RZR 800 11	1142-0241
RANGER SERIES 10 425 2X4 03	1142-0239
RANGER SERIES 10 500 4X4 03	1142-0239
RANGER SERIES 10 500 6X6 03	1142-0239
RANGER 700 XP 09	1142-0240
SUZUKI	
KING QUAD 700 05-07	1142-0246
TWIN PEAKS 700 04-06	1142-0245
KINGQUAD 750 AXI 08-10	1142-0246
YAMAHA	
GRIZZLY 600 4X4 AUTO 98-01	1142-0243
GRIZZLY 660 4X4 AUTO 02-08	1142-0243
RHINO 660 05-07	1142-0243



HIGH PERFORMANCE PLUS DRIVE BELTS > \$99.95
Provides fast, more consistent throttle response at high speeds and quicker throttle response at mid-speed acceleration. Greater secondary acceleration at high RPM's. Reduction in slippage during the highest levels of torque. Increased horsepower capacity. Better performance during deceleration. Tested and proven reliable at well over 12,000 RPM's. Cooler running than the leading competitors. Made in the USA.

FITS MODEL	PART #
HIGH PERFORMANCE PLUS DRIVE BELTS	
ARCTIC CAT	
366 09	1142-0294
366 4X4 AUTO 08	1142-0294
366 SE 10-11	1142-0294
TRV 400 09-10	1142-0294
TRV 450 11	1142-0294
450 H1 EFI 10-11	1142-0294
450 LTD 11	1142-0294
650 4X4 AUTO 04	1142-0249
650 4X4 AUTO LE 04&06	1142-0249
650 V2 4X4 AUTO 05-06	1142-0249
700 EFI 4X4 AUTO 06-08	1142-0271
700 EFI 4X4 AUTO LE 07-08	1142-0271
700 EFI 4X4 AUTO TRV LE 08	1142-0271
700 EFI CRUISER 08	1142-0271
MUD PRO 1000 H2 EFI 10-11	1142-0271
THUNDERCAT 1000 H2 09-10	1142-0271
THUNDERCAT 1000 H2 LE 10	1142-0271
TRV 1000 CRUISER 11	1142-0271
TRV 1000 H2 EFI 10	1142-0271
TRV 1000 H2 EFI CRUISER 09-10	1142-0271
1000 LTD 11	1142-0271
PROWLER XTZ 1000 H2 EFI 09	1142-0271
PROWLER XTZ 1000 10-13	1142-0271
WILDCAT 1000 12-13	1142-0271
CAN-AM	
OUTLANDER 500 07-08	1142-0248
OUTLANDER 500 EFI 09-13	1142-0248
OUTLANDER 500 EFI XT 09	1142-0248
OUTLANDER 500 XT 07-08	1142-0248
OUTLANDER MAX 500 EFI 09-13	1142-0248
OUTLANDER MAX 500 EFI LTD 09	1142-0248
OUTLANDER MAX 500 EFI XT 09	1142-0248

FITS MODEL	PART #
HIGH PERFORMANCE PLUS DRIVE BELTS (CON'T)	
CAN-AM (CON'T)	
RENEGADE 500 08	1142-0248
RENEGADE 500 EFI 09-13	1142-0248
OUTLANDER 650 HO EFI 06	1142-0248
OUTLANDER 650 HO EXI XT 06	1142-0248
OUTLANDER 650 MAX HO EFI 06	1142-0248
OUTLANDER 650 MAX HO EXI XT 06	1142-0248
OUTLANDER 650 07-08	1142-0248
OUTLANDER 650 EFI 09-13	1142-0248
OUTLANDER 650 EFI XT 09	1142-0248
OUTLANDER 650 HO EFI 08	1142-0248
OUTLANDER 650 XT 07-08	1142-0248
OUTLANDER MAX 650 EFI 09-13	1142-0248
OUTLANDER MAX 650 EFI XT 09	1142-0248
OUTLANDER 800 HO EFI 4X4 06	1142-0248
OUTLANDER MAX 800 HO EFI 06	1142-0248
OUTLANDER 800 HO EFI 08	1142-0248
OUTLANDER 800R EFI 09-13	1142-0248
OUTLANDER 800R EFI XT 09	1142-0248
OUTLANDER MAX 800 07-08	1142-0248
OUTLANDER MAX 800 LTD 07-08	1142-0248
OUTLANDER MAX 800 XT 07-08	1142-0248
OUTLANDER MAX 800R EFI 09-13	1142-0248
OUTLANDER MAX 800R EFI XT 09	1142-0248
OUTLANDER MAX 800R LTD 09-13	1142-0248
OUTLANDER 1000 13	1142-0248
RENEGADE 800 07-08	1142-0248
RENEGADE 800 HO EFI 08	1142-0248
RENEGADE 800 X 08	1142-0248
RENEGADE 800R EFI 09-13	1142-0248
RENEGADE 800R EFI X 09	1142-0248
COMMANDER 1000 11-12	1142-0248
COMMANDER 1000 X 11-12	1142-0248
COMMANDER 1000 XT 11-12	1142-0248
COMMANDER 800 R 11-12	1142-0248
COMMANDER 800R XT 11	1142-0248
RENEGADE 1000 EFI 12-13	1142-0248
KAWASAKI	
PRAIRIE 650 4X4 02-03	1142-0250
PRAIRIE 650 4X4 W/AFTERMARKET CLUTCH 02-03	1142-0249
BRUTE FORCE 650 05-03	1142-0249
BRUTE FORCE 650 4X4 05-12	1142-0249
BRUTE FORCE 650 4X4 06-13	1142-0249
KFX 700 04-09	1142-0249
KFX 700 V FORCE 04-05	1142-0249
BRUTE FORCE 750 05-09	1142-0249
BRUTE FORCE 750 4X4 05-11	1142-0249
BRUTE FORCE 750 4X4 12-13	1142-0250
PRAIRIE 700 4X4 04-06	1142-0249
TERYX 750 08-10	1142-0250
TERYX 750 FI 4X4 11-12	1142-0250
TERYX 750 FI 4X4 LE 11-12	1142-0250
TERYX 750 FI 4X4 LE SGE 11	1142-0250
TERYX 750 FI 4X4 SPORT 11-12	1142-0250
TERYX 750 LE 08-13	1142-0250
TERYX 750 4 FI 4X4 12-13	1142-0446
MULE 4010 ALL YEARS	1142-0444
MULE 4010 DIESEL ALL YEARS	1142-0444
MULE 4010 TRANS	1142-0444
MULE 4010 TRANS DIESEL	1142-0444
POLARIS	
SPORTSMAN 500 EFI 08	1142-0300
SPORTSMAN 500 EFI SCANDINAVIAN 08	1142-0300
SPORTSMAN 500 EFI TOURING 08	1142-0300
SPORTSMAN 500 EFI X2 07-08	1142-0300
SPORTSMAN 500 HO EFI 08-13	1142-0300
SPORTSMAN 500 HO TOURING 10-12	1142-0300
SPORTSMAN TOURING 500 EFI 09	1142-0300
SPORTSMAN TOURING 500 HO 11	1142-0300
SPORTSMAN 550 10-13	1142-0295
SPORTSMAN 550 EPS 10-12	1142-0295
SPORTSMAN 550 TOURING EPS 10-12	1142-0295
SPORTSMAN 550 X2 10-13	1142-0295
SPORTSMAN 700 EFI X2 08	1142-0300
SPORTSMAN 800 10	1142-0300
SPORTSMAN 800 6X6 10	1142-0300
SPORTSMAN 800 EFI 05-06	1142-0298

PLOWS
WINCHES
UTV
RACKS
LUGGAGE
BODY
CONTROLS
ELECTRICAL
WHEELS & TIRES
SUSPENSION & DRIVE
ENGINE
NRA BY MODEL
RIDER
TOWING
GARAGE
PROMO

FITS MODEL	PART #
HIGH PERFORMANCE PLUS DRIVE BELTS (CON'T)	
POLARIS (CON'T)	
SPORTSMAN 800 EFI 08	1142-0300
SPORTSMAN 800 EFI 10-12	1142-0300
SPORTSMAN 800 EFI 6X6 09	1142-0300
SPORTSMAN 800 EFI TOURING 08	1142-0300
SPORTSMAN 800 EFI X2 07-08	1142-0300
SPORTSMAN 800 HO EFI 08-09	1142-0300
SPORTSMAN 850 TOURING EPS 10-11	1142-0295
SPORTSMAN 850 XP 10-13	1142-0295
SPORTSMAN 850 XP EPS 10-13	1142-0295
SPORTSMAN BIG BOSS 6X6 800 11	1142-0300
SPORTSMAN TOURING 800 EFI 09	1142-0300
SPORTSMAN 800 X2 08	1142-0300
SPORTSMAN XP 850 09	1142-0295
RANGER 500 EFI 11-13	1142-0300
RANGER 700 4X4 07-09	1142-0298
RANGER 700 6X6 07-08	1142-0298
RANGER 6X6 800 11-12	1142-0301
RANGER 800 6X6 10	1142-0301
RANGER 800 CREW 10	1142-0301
RANGER 800 HD 10	1142-0301
RANGER 800 XP 10-13	1142-0301
RANGER 800 XP EPS 10	1142-0301
RANGER CREW 500 EFI 11	1142-0300
RANGER CREW 800 11-13	1142-0301
RANGER 800 HD 09	1142-0298
RANGER XP 800 EFI 11	1142-0301
RZR 570 12	1142-0445
RZR 800 08-09	1142-0300
RZR 800 11-13	1142-0301
RZR 800 S 09	1142-0297
RZR S 800 10-13	1142-0301
RZR XP 900 11	1142-0412
RZR XP 900 13	1142-0420

SUZUKI	
KING QUAD 450 07	1142-0296
KING QUAD 450 AXI 07-10	1142-0296
KING QUAD 450AXI LIMITED EDITION 08	1142-0296
KING QUAD 500 AXI POWER STEERING 09	1142-0296
KING QUAD 700 05-07	1142-0271
TWIN PEAKS 700 04-06	1142-0249
KINGQUAD 750 AXI 08-10	1142-0271
KINGQUAD 750 AXI LIMITED 08-09	1142-0271

YAMAHA	
BRUIN 350 4X4 AUTO 04-06	1142-0250
GRIZZLY 350 AUTO 08-11	1142-0250
GRIZZLY 350 AUTO 4X4 IRS 07-11	1142-0250
GRIZZLY 400 AUTO 4X4 07	1142-0250
GRIZZLY 450 AUTO 4X4 07	1142-0250
GRIZZLY 450 AUTO 4X4 IRS 09	1142-0250
GRIZZLY 600 4X4 AUTO 98-01	1142-0299
GRIZZLY 660 4X4 AUTO 02-08	1142-0299
GRIZZLY 700 FI AUTO 4X4 07-13	1142-0247
RHINO 700 FI AUTO 4X4 08-12	1142-0247
RHINO 700 FI AUTO 4X4 SE 08-12	1142-0247



SHOCK COVERS > \$11.95-\$19.95
 Protects your shocks from mud, dust and debris. Made of durable 400 denier nylon cloth. Strong, durable 2" hook-and-loop closure strip. High-strength elastic at both ends and four vented holes for better ventilation. Made in the USA.

BLACK	RED	BLUE	WIDTH	LENGTH
MUD-P09	MUD-P18	MUD-P27	10"	13"
MUD-P19	-	-	9 3/4"	10 1/2"
MUD-P29	-	-	10 1/2"	12 1/4"
MUD-S09	MUD-S18	MUD-S27	11"	12"
MUD-S29	MUD-S38	MUD-S47	12 1/2"	14 3/4"
MUD-S19	-	-	11 1/2"	13 1/2"

HONDA SWINGARM BOLT KITS > \$9.95

Fits Honda models 1988-2012. Direct stock replacement. 40% less than OEM retail. Sold in pairs. Imported.



FITS MODEL	PART #
SWINGARM BOLT KITS	
HONDA	
TRX250 RECON 97-12	1302-0471
TRX300 FOURTRAX 300 88-00	1302-0471
TRX300FW FOURTRAX 4X4 88-00	1302-0471
TRX350FE 00-06	1302-0471
TRX350FM FOURTRAX RANCHER 00-06	1302-0471
TRX350TE 00-06	1302-0471
TRX350TM FOURTRAX RANCHER 00-06	1302-0471
TRX400FA 04-07	1302-0471
TRX400FGA FOURTRAX RANCHER 4X4 04-07	1302-0471
TRX400FW FOURTRAX FOREMAN 4X4 95-01	1302-0471
TRX450ES 98-01	1302-0471
TRX450S 98-01	1302-0471
TRX500FA 07-12	1302-0471
TRX500FE 07-11	1302-0471
TRX500FGA 07-09	1302-0471
TRX500FM 07-11	1302-0471
TRX500FGA 09-12	1302-0471
TRX500FPE 08-11	1302-0471
TRX500FPM 08-11	1302-0471



LIFT KITS > \$99.95-\$214.95

Increases clearance by 1"-1.5". Made of stainless steel. Easy installation, no special tools required. Imported.

FITS MODEL	PART #
LIFT KITS	
ARCTIC CAT	
TRV 400 08-10	1304-0526
TRV 450 11-13	1304-0526
TRV 500 08	1304-0526
TRV 550 09-13	1304-0526
550 AUTO 09-13	1304-0526
TRV 650 08-09	1304-0526
TRV 700 08-13	1304-0526
700 AUTO 08-13	1304-0526
TRV 1000 09-13	1304-0526
1000 AUTO T-CAT 08-13	1304-0526
PROWLER 550 09-13	1304-0522
PROWLER 650 06-09	1304-0522
PROWLER 700 08-13	1304-0522
PROWLER 1000 09-13	1304-0522

CAN-AM	
800/1000 OUTLANDER 09-13	1304-0558
COMMANDER 800/1000 11-13	1304-0521

HONDA	
TRX300 FOURTRAX 93-00	1304-0510
TRX350 RANCHER 00-06	1304-0514
TRX400 FOREMAN 95-04	1304-0511
TRX400 RANCHER AT 04-07	1304-0514
TRX420 RANCHER 07-12	1304-0530
TRX420 RANCHER AT IRS 09-13	1304-0531
TRX450 FOREMAN 98-04	1304-0512
TRX500 RUBICON 01-13	1304-0513
TRX500 FOREMAN 05-11	1304-0513
TRX500 FOREMAN 12-13	1304-0523
TRX650 RINCON 03-05	1304-0529
TRX680 RINCON 06-13	1304-0529

KAWASAKI	
KVF360 PRAIRIE 03-12	1304-0515
KVF650 PRAIRIE 02-06	1304-0515
KVF650 BRUTE FORCE 05-12	1304-0515

FITS MODEL	PART #
LIFT KITS (CON'T)	
KAWASAKI (CON'T)	
KVF650I BRUTE FORCE 06-13	1304-0520
KVF700 PRAIRIE 04-06	1304-0515
KVF750 BRUTE FORCE 05-13	1304-0520
TERYX 750 08-13	1304-0532
POLARIS	
SPORTSMAN 400 05	1304-0525
SPORTSMAN 450 05-07	1304-0525
SPORTSMAN 500 05-13	1304-0525
SPORTSMAN 600 05	1304-0525
SPORTSMAN 700 05-07	1304-0525
SPORTSMAN 800 05-13	1304-0525
RZR 800 09-12	1304-0524
RZR XP900 11-13	1304-0533
SUZUKI	
EIGER 400 00-07	1304-0517
KING QUAD 400 08-12	1304-0517
KING QUAD 450 07-13	1304-0519
VINSON 500 00-07	1304-0518
KING QUAD 500 09-13	1304-0519
KING QUAD 700 05-07	1304-0519
KING QUAD 750 08-13	1304-0519
YAMAHA	
BRUIN/GRIZZLY 350 03-09	1304-0527
BIG BEAR 400 00-09	1304-0516
KODIAK 400 03-04	1304-0527
KODIAK 450 03-04	1304-0527
GRIZZLY 550 09-13	1304-0528
GRIZZLY 700 07-13	1304-0528
RHINO 08-13	1304-0542



FRONT AND REAR SHOCK BEARING KITS > 12.95-\$37.95

OEM replacement parts designed to rebuild the shock to factory specification. Kit contains bearings, seals, spacers and pins. Imported.



FITS MODEL	FRONT PART #	REAR PART #
SHOCK BEARING KITS		
ARCTIC CAT		
250 2X4 99-05	1313-0027	1313-0027
250 2X4 06-09	-	1313-0027
250 4X4 01-05	1313-0027	1313-0027
300 2X4 98-04	1313-0027	1313-0027
300 4X4 98-05	1313-0027	1313-0027
375 2X4 & 4X4 W/AT 02	1313-0027	1313-0027
400 2X4 98-01	1313-0027	1313-0027
400 2X4 FIS W/AT & 400 2X4 FIS W/MT 03-04	1313-0027	1313-0027
400 4X4 98-00	1313-0027	1313-0027
400 4X4 W/AT 03-04	1313-0027	1313-0027
400 4X4 W/MT 01-04	1313-0027	1313-0027
400 FIS 4X4 W/AT 03-06	1313-0027	1313-0027
400 FIS 4X4 W/MT 02-06	1313-0027	1313-0027
400 TBX 4X4 04-06	1313-0027	1313-0027
400 VP 4X4 06	1313-0027	1313-0027
454 2X4 97-98	1313-0027	1313-0027
454 4X4 96-98	1313-0027	1313-0027
500 4X4 98-99	1313-0027	1313-0027
500 4X4 W/AT 00-02	1313-0027	1313-0027
500 4X4 W/MT 00-01	1313-0027	1313-0027
500 FIS 4X4 W/AT 02-06	1313-0027	1313-0027
500 FIS 4X4 W/MT 02	1313-0027	1313-0027
500 FIS 4X4 W/MT 04-06	1313-0027	1313-0027
500 FIS TBX 4X4 02-06	1313-0027	1313-0027
500 FIS TRV 4X4 03-06	1313-0027	1313-0027
650 4X4 HI 05-06	1313-0027	1313-0027
650 4X4 W/AT V2 04-06	1313-0027	1313-0027
HONDA		
TRX350FE & TRX350TE 00-06	1313-0031	-
TRX350FM & TRX350TM RANCHER 00-06	1313-0031	-
TRX400FA 04-07 & TRX400FGA RANCHER 4X4 04-07	1313-0031	-
TRX450ES 98-01	1313-0030	-
TRX450FE/FM 02-04	1313-0030	-
TRX450S 98-01	1313-0030	-
TRX500FA 01-06	1313-0010	1313-0010
TRX500FA 07-13	1313-0031	1313-0031
TRX500FE 05-06	1313-0010	1313-0010
TRX500FE 07	1313-0031	1313-0010
TRX500FE 08-11	1313-0031	1313-0031
TRX500FE 12-13	1313-0031	-
TRX500FGA 04-06	1313-0010	1313-0010
TRX500FGA 07-09	1313-0031	1313-0031
TRX500FM 05-06	1313-0010	1313-0010
TRX500FM 07-11	1313-0031	1313-0031
TRX500FM 12-13	1313-0031	-
TRX500FPA 09-13	1313-0031	1313-0031
TRX500FPE 08-11 & TRX500FPM 08-11	1313-0031	1313-0031
TRX500FPE 12 & TRX500FPM 12	1313-0031	-
TRX500TM 05-06	1313-0010	1313-0010
TRX650 RINCON 03-05	1313-0010	-
TRX680 RINCON 06-13	1313-0010	-

WHEEL BEARING KITS > \$7.95-\$66.95

Includes all bearings and seals required to rebuild one wheel. EMQ premium-quality, high-speed bearings feature double-lip rubber seals. Specifically designed to keep out dirt and water while providing superior grease retention. Seals contain a garter-spring inner lip that guarantees an optimum seal. Imported.



FITS MODEL	FRONT KIT PART #	FRONT STRUT KIT PART #	REAR KIT PART #
WHEEL BEARING KITS			
	QTY		QTY
ARCTIC CAT			
50 2X4 08	0215-0151	2	0215-0224 1
50 Y-6 YOUTH 04-06	0215-0151	2	0215-0077 1
90 UTILITY 07-13	0215-0151	2	0215-0077 1
90 Y-12 YOUTH 02-06	0215-0151	2	0215-0077 1

FITS MODEL	FRONT KIT PART #	FRONT STRUT KIT PART #	REAR KIT PART #
WHEEL BEARING KITS (CON'T)			
ARCTIC CAT (CON'T)			
250 2X4 99-05	0215-0076	2	0215-0076 2
250 2X4 06-09	A25-1035	2	-
250 4X4 01-04	0215-0076	2	0215-0076 2
250 4X4 05	0215-0153 ¹	2	0215-0153 ¹ 2
300 2X4 98-04	0215-0076	2	0215-0076 2
300 2X4 10-12	A25-1035	2	-
300 4X4 98-04	0215-0076	2	0215-0076 2
300 4X4 05	0215-0153 ¹	2	0215-0153 ¹ 2
DVX300 09-12	A25-1035	2	0215-0245 1
366 FIS W/AT 08-10	0215-0153 ¹	2	0215-0153 ¹ 2
375 02	0215-0076	2	0215-0081 1
400 98-00	0215-0076	2	0215-0080 1
400 01-04	0215-0076	2	0215-0081 1
400 FIS 02-04	0215-0076	2	0215-0076 2
400 FIS 05-08	0215-0153 ¹	2	0215-0153 ¹ 2
400 FIS 4X4 TRV 09-13	0215-0153 ¹	2	0215-0153 ¹ 2
400 TBX 4X4 04	0215-0076	2	0215-0076 2
400 TBX 4X4 05-06	0215-0153 ¹	2	0215-0153 ¹ 2
400 TRV 07	0215-0153 ¹	2	0215-0153 ¹ 2
400 VP 4X4 06	0215-0153 ¹	2	0215-0153 ¹ 2
450 HI 10-11	0215-0153 ¹	2	0215-0153 ¹ 2
454 96-98	0215-0076	2	0215-0080 1
500 EFI	0215-0153	2	0215-0153 2
500 TRV	0215-0153	2	0215-0153 2
500 XT EFI	0215-0153	2	0215-0153 2
550 EFI 4X4	0215-0153	2	0215-0153 2
500 4X4 98-99	0215-0076	2	0215-0080 1
500 4X4 00-02	0215-0076	2	0215-0081 1
500 FIS 4X4 02-04	0215-0076	2	0215-0076 2
500 FIS 4X4 05-09	0215-0153	2	0215-0153 2
500 FIS TBX 4X4 02	0215-0076	2	0215-0081 1
500 FIS TBX 4X4 03-04	0215-0076	2	0215-0076 2
500 FIS TBX 4X4 05-06	0215-0153	2	0215-0153 2
500 FIS TRV 4X4 03-04	0215-0076	2	0215-0076 2
500 FIS TRV 4X4 05-08	0215-0153 ¹	2	0215-0153 ¹ 2
550 HI EFI 11	0215-0153 ¹	2	0215-0153 ¹ 2
550 HI FIS 4X4 W/MT 09-10	0215-0153 ¹	2	0215-0153 ¹ 2
550 LTD EFI 11	0215-0153 ¹	2	0215-0153 ¹ 2
550 TRV 11-13	0215-0153 ¹	2	0215-0153 ¹ 2
550 TRV 4X4 W/AT 09-10	0215-0153 ¹	2	0215-0153 ¹ 2
550 PROWLER XT 09-13	0215-0153 ¹	2	0215-0153 ¹ 2
650 4X4 HI 05-10	0215-0153 ¹	2	0215-0153 ¹ 2
650 4X4 W/AT V2 04	0215-0076	2	0215-0153 ¹ 2
650 4X4 W/AT V2 05-06	0215-0153 ¹	2	0215-0153 ¹ 2
650 PROWLER XT 06-09	0215-0153 ¹	2	0215-0153 ¹ 2
700 DIESEL 08	0215-0153 ¹	2	0215-0153 ¹ 2
700 EFI 4X4 07-12	0215-0153 ¹	2	0215-0153 ¹ 2
700 EFI HI MUDPRO 09-10	0215-0153 ¹	2	0215-0153 ¹ 2
700 EFI HI W/AT 08-10	0215-0153 ¹	2	0215-0153 ¹ 2
700 HI TRV 11	0215-0153 ¹	2	0215-0153 ¹ 2
700 LTD 11	0215-0153 ¹	2	0215-0153 ¹ 2
700 TRV 08	0215-0153 ¹	2	0215-0153 ¹ 2
700 PROWLER XTX 08-13	0215-0153 ¹	2	0215-0153 ¹ 2
1000 CRUISER 12	0215-0153 ¹	2	0215-0153 ¹ 2
1000 TRV GT 12	0215-0153 ¹	2	0215-0153 ¹ 2
1000 TRV LTD 13	0215-0153 ¹	2	0215-0153 ¹ 2
1000 XT 13	0215-0153 ¹	2	0215-0153 ¹ 2
1000I GT 12	0215-0153 ¹	2	0215-0153 ¹ 2
1000I LTD EFI MUDPRO 12-13	0215-0153 ¹	2	0215-0153 ¹ 2
1000 H2 MUDPRO 10	0215-0153 ¹	2	0215-0153 ¹ 2
1000 H2 THUNDERCAT 08-10	0215-0153 ¹	2	0215-0153 ¹ 2
PROWLER H2 1000 XTX 09-12	0215-0153 ¹	2	0215-0153 ¹ 2
WILDCAT GT 12	0215-0153 ¹	2	-
CAN-AM			
DS50 02-06	0215-0151	2	0215-0077 1
DS70 08-12	0215-0151	2	0215-0077 1
DS90 02-12	0215-0151	2	0215-0077 1
RALLY 175 03-07	0215-0152	2	0215-0156 1
OUTLANDER 330 04-05	0215-0167	2	-
OUTLANDER 400 03-05	0215-0167	2	-
OUTLANDER 400 06-13	0215-0165	2	0215-0165 2
OUTLANDER 500 07-13	0215-0165	2	0215-0165 2
OUTLANDER 500 POWER STEERING 10-12	0215-0165	2	0215-0165 2
QUEST 500 02-03	0215-0244	2	-
RENEGADE 500 08-13	0215-0165	2	0215-0165 2

CONTINUED ON NEXT PAGE

PLOWS
WINCHES
UTILITY
RACKS
LUGGAGE
BODY
CONTROLS
ELECTRICAL
WHEELS & TIRES
SUSPENSION & DRIVE
ENGINE
NRA BY MOOSE
RIDER
TOWING
GARAGE
PROMO



FITS MODEL	FRONT KIT PART #	FRONT STRUT KIT PART #	REAR KIT PART #	QTY
WHEEL BEARING KITS (CON'T)				
CAN-AM (CON'T)				
TRAXTER 500 99-01	0215-0243	2 -	-	-
TRAXTER 500 02-05	0215-0244	2 -	-	-
OUTLANDER 650 07-13	0215-0165	2 -	0215-0165	2
OUTLANDER 650 POWER STEERING 10-12	0215-0165	2 -	0215-0165	2
QUEST 650 02-04	0215-0244	2 -	-	-
TRAXTER 650 04-05	0215-0244	2 -	-	-
OUTLANDER 800 06-13	0215-0165	2 -	0215-0165	2
OUTLANDER 800 POWER STEERING 10-12	0215-0165	2 -	0215-0165	2
RENEGADE 800 07-13	0215-0165	2 -	0215-0165	2
RENEGADE 800 POWER STEERING 10-12	0215-0165	2 -	0215-0165	2
OUTLANDER 1000 12-13	0215-0165	2 -	0215-0165	2
RENEGADE 1000 12-13	0215-0165	2 -	0215-0165	2
COMMANDER 800 11-13	0215-0165	2 -	0215-0165	2
COMMANDER 1000 11-13	0215-0165	2 -	0215-0165	2
ETON				
IXL-40 RASCAL	0215-0151	2 -	-	-
RXL-40	0215-0151	2 -	-	-
AXL-50	0215-0151	2 -	-	-
NXL-50	0215-0151	2 -	-	-
RXL50	0215-0151	2 -	-	-
TXL 50	0215-0151	2 -	-	-
RX4-70	0215-0151	2 -	-	-
RXL 70	0215-0151	2 -	-	-
AXL 90	0215-0151	2 -	-	-
NXL-90	0215-0151	2 -	-	-
RX4-90R	0215-0151	2 -	-	-
RXL 90	0215-0151	2 -	-	-
TXL90	0215-0151	2 -	-	-
CXL-150	A25-1063	2 -	-	-
RXL150	A25-1063	2 -	-	-
YXL150	A25-1063	2 -	-	-
HONDA				
ATC70 73-77	A25-1187	1 -	-	-
ATC70 78-85	A25-1187	1 -	A25-1108	1
TRX70 86-87	A25-1050	2 -	A25-1108	1
TRX90 93-13	A25-1052	2 -	A25-1029	1
ATC110 79-81	-	-	A25-1122	1
ATC110 82-85	A25-1317	1 -	A25-1122	1
ATC125M 84-85	A25-1317	1 -	A25-1122	1
ATC125M 86-87	A25-1317	1 -	A25-1032	1
TRX125 85-86	A25-1052	2 -	A25-1122	1
TRX125 87-88	A25-1052	2 -	A25-1032	1
ATC185 80-83	A25-1317	1 -	A25-1122	1
ATC200E 82-83	A25-1317	1 -	A25-1122	1
ATC200ES 84	A25-1317	1 -	-	-
ATC200M, S 84-86	A25-1317	1 -	A25-1122	1
ATC200X 83-85	A25-1317	1 -	A25-1122	1
ATC200X 86-87	A25-1317	1 -	-	-
TRX200 84	A25-1112	2 -	-	-
TRX200 90-97	0215-0163	2 -	A25-1124	1
TRX200D 90-97	0215-0163	2 -	A25-1124	1
ATC250ES 85	A25-1317	1 -	A25-1019	1
ATC250ES 86-87	A25-1317	1 -	A25-1036	1
ATC250SX 85	A25-1317	1 -	A25-1019	1
ATC250SX 86-87	A25-1317	1 -	A25-1036	1
FL250 77-84	A25-1070	2 -	-	-
TRX250 FOURTRAX 85-87	A25-1112	2 -	A25-1036	1
TRX250 RECON 97-13	0215-0163	2 -	A25-1034	1
TRX300 FOURTRAX 300 88-92	A25-1035	2 -	A25-1123	1
TRX300 FOURTRAX 300 93-00	A25-1112	2 -	A25-1123	1
TRX300FW FOURTRAX 4X4 88-00	A25-1003	2 -	A25-1123	1
ATC350X 85-86	A25-1317	2 -	A25-1320	1
FL350 85	A25-1112	2 -	-	-
TRX350 86	-	-	A25-1036	1
TRX350 87	A25-1004	2 -	A25-1036	1
TRX350D 87-89	A25-1004	2 -	A25-1036	1
TRX350FE/FM 00-06	0215-0164	2 -	A25-1037	1
TRX350TE/TM 00-06	0215-0163	2 -	A25-1037	1
TRX400FA/FGA 04-07	0215-0164	2 -	A25-1037	1
TRX400FW FOURTRAX FOREMAN 4X4 95-03	A25-1005	2 -	A25-1037	1
TRX420 FA/FPA 09-13	A25-1003	2 -	0215-0737	1
TRX420 FE/FM 07-13	A25-1003	2 -	0215-0250	1
TRX420 TE/TM 07-13	0215-0200	2 -	0215-0250	1
TRX450ES 98-01	A25-1005	2 -	A25-1037	1
TRX450FE/FM 02-04	A25-1005	2 -	A25-1037	1

FITS MODEL	FRONT KIT PART #	FRONT STRUT KIT PART #	REAR KIT PART #	QTY
WHEEL BEARING KITS (CON'T)				
HONDA (CON'T)				
TRX450S 98-01	A25-1005	2 -	A25-1037	1
TRX500FA 01-04	A25-1005	2 -	A25-1037	1
TRX500FGA 04	A25-1005	2 -	A25-1037	1
TRX500FA/FE/FGA 05-13	0215-0249	2 -	A25-1037	1
TRX500FM/FPA 05-13	0215-0249	2 -	A25-1037	1
TRX500FPE/FPM 08-13	0215-0249	2 -	A25-1037	1
TRX500TM 05-06	0215-0200	2 -	A25-1037	1
TRX650 RINCON 03-05	A25-1005	2 -	0215-0155	2
TRX680 RINCON 06-13	0215-0249	2 -	0215-0155	2
KAWASAKI				
KLF110 87-88	A25-1215	2 -	-	-
KLT110 84-86	A25-1046	1 -	-	-
KLT160 85	A25-1046	1 -	-	-
KLF185 BAYOU 85-88	A25-1215	2 -	-	-
KLT185 86-87	A25-1046	1 -	-	-
KLT200A 81-83	A25-1046	1 -	0215-0245	1
KLT200B 83	A25-1046	1 -	-	-
KLT200C 83-84	A25-1046	1 -	-	-
KLF220 BAYOU 88-02	A25-1088	2 -	A25-1275	1
KLF250 BAYOU 03-11	A25-1088	2 -	A25-1275	1
KLT250A 82-83	A25-1046	1 -	-	-
KLT250C 83-85	A25-1046	1 -	-	-
KEF300 LAKOTA 95-03	A25-1023	2 -	A25-1132	1
KLF300A BAYOU 86-87	A25-1070	2 -	A25-1274	1
KLF300B BAYOU 88-04	A25-1023	2 -	A25-1274	1
KLF300C BAYOU 4X4 89-04	0215-0159	2 -	A25-1275	1
KVF300A PRAIRIE 4X4 99-02	0215-0159	2 -	A25-1146	1
KVF300B PRAIRIE 2X4 99-00	0215-0159	2 -	A25-1146	1
KVF300B PRAIRIE 2X4 01-02	0215-0157	2 -	A25-1146	1
KVF300 BRUTE FORCE 12-13	A25-1035	2 -	-	-
MULE 500 91-95	A25-1403	-	A25-1274	1
MULE 520 00-01	A25-1403	-	A25-1274	1
MULE 550 97-04	A25-1403	-	A25-1274	1
KVF360A, C PRAIRIE 4X4 03-13	0215-0157	2 -	-	-
KVF360B PRAIRIE 03-12	0215-0157	2 -	-	-
KLF400 BAYOU 93-99	0215-0159	2 -	A25-1275	1
KVF400A, B PRAIRIE 97-98	0215-0159	2 -	A25-1146	1
KVF400C, D PRAIRIE 99-00	0215-0159	2 -	A25-1146	1
KVF400C, D PRAIRIE 01-02	0215-0157	2 -	A25-1146	1
MULE 600 05-13	0215-0202	2 -	-	-
MULE 610 4X4 05-13	0215-0202	2 -	-	-
MULE 1000 88	A25-1403	-	A25-1405	1
MULE 2010 90	A25-1404	2 -	A25-1405	1
MULE 2020 90	A25-1404	2 -	A25-1405	1
MULE 2030 91	A25-1404	2 -	A25-1405	1
MULE 2500 94-00	A25-1404	2 -	A25-1405	1
MULE 2510 4X4 93-00	A25-1404	2 -	A25-1405	1
MULE 2520 93-00	A25-1404	2 -	A25-1405	1
MULE 3000 01-08	A25-1404	2 -	0215-0202	2
MULE 3010 4X4 01-08	A25-1404	2 -	0215-0202	2
MULE 3020 01-03	A25-1404	2 -	0215-0202	2
MULE 4000 09-13	A25-1404	2 -	0215-0202	2
MULE 4010 4X4 09-13	A25-1404	2 -	0215-0202	2
KVF650 BRUTE FORCE 05-12	0215-0157	2 -	-	-
KVF650 I BRUTE FORCE 06-13	0215-0157	2 -	0215-0202	2
KVF650 PRAIRIE 02-03	0215-0157	2 -	-	-
KFX 700 V-FORCE 04-09	A25-1035	2 -	-	-
KVF700 PRAIRIE 04-06	0215-0157	2 -	-	-
KVF750 BRUTE FORCE 05-13	0215-0157	2 -	0215-0202	2
TERYX 750 WW4 4X4 12	0215-0153	2 -	-	-
TERYX 750 4X4 08-13	0215-0153	2 -	0215-0202	2
MULE 2510 DIESEL 00	A25-1404	2 -	A25-1405	1
MULE 2510 DIESEL 01-02	A25-1404	2 -	0215-0202	2
MULE 3010 DIESEL 03-06	A25-1404	2 -	0215-0202	2
MULE 4010 4X4 DIESEL 10-12	A25-1404	2 -	0215-0202	2
KYMCO				
MAXXER 50	0215-0151	2 -	0215-0077	1
MONGOOSE 50 03-05	0215-0151	2 -	0215-0077	1
MONGOOSE 50 08	0215-0151	2 -	0215-0077	1
MONGOOSE 50 4 STROKE 06	0215-0151	2 -	0215-0077	1
MONGOOSE 06-08	0215-0151	2 -	0215-0077	1
MONGOOSE 90 04-05	0215-0151	2 -	0215-0077	1
KXR250	A25-1035	2 -	0215-0245	1
MAXXER 250	A25-1035	2 -	0215-0245	1
MONGOOSE 250 04-08	A25-1035	2 -	0215-0245	1

CONTINUED ON NEXT PAGE

FITS MODEL	FRONT KIT PART #	FRONT STRUT KIT PART #	REAR KIT PART #	QTY	
WHEEL BEARING KITS (CON'T)					
KYMCO (CON'T)					
MXU250 04-05	A25-1035	2	0215-0245	1	
MAXXR 300	A25-1035	2	0215-0245	1	
MONGOOSE 300 05-08	A25-1035	2	0215-0245	1	
MXU 300 05-08	A25-1035	2	-	-	
MXU 400	0215-0153 ¹	2	0215-0153 ¹	2	
MXU 500 2WD	0215-0153 ¹	2	-	-	
MXU 500 4WD	0215-0153 ¹	2	-	-	
POLARIS					
SPORTSMAN 90 01-03	0215-0151	2	0215-0077	1	
SPORTSMAN 90 04-13	0215-0151	2	0215-0224	1	
PHOENIX 200 06-13	0215-0160	2	-	-	
CYCLONE 250 87	-	-	A25-1321	1	
TRAIL BLAZER 250 90-98	A25-1129	2	A25-1321	1	
TRAIL BLAZER 250 99-04	A25-1129	2	A25-1151	1	
TRAIL BLAZER 250 05-06	0215-0160	2	A25-1151	1	
TRAIL BOSS 250 85-87	-	-	A25-1321	1	
TRAIL BOSS 250 88-99	A25-1129	2	A25-1321	1	
TRAIL BOSS 250 4X4 87-88	A25-1008	2	A25-1321	1	
TRAIL BOSS 250 4X4 89-90	A25-1008	2	A25-1321	1	
TRAIL BOSS 250 4X4 91-93	A25-1008	2	A25-1007	A25-1321	1
XPLORER 250 4X4 00-02	A25-1008	2	A25-1006	A25-1151	1
BIG BOSS 250 4X6 89-92	A25-1129	2	A25-1321	1	
BIG BOSS 250 6X6 91-93	A25-1008	2	A25-1007	A25-1321	1
300 2X4 94-95	A25-1129	2	A25-1321	1	
300 4X4 94	A25-1008	2	A25-1006	A25-1321	1
HAWKEYE 06-11	0215-0078	2	0215-0078	2	
SPORTSMAN 300 4X4 08-11	0215-0078	2	0215-0078	2	
TRAIL BOSS 300 4X4 95	A25-1008	2	A25-1006	A25-1321	1
XPLORER 300 4X4 96-98	A25-1008	2	A25-1006	A25-1321	1
XPLORER 300 4X4 99	A25-1008	2	A25-1006	-	-
XPRESS 300 96-99	A25-1129	2	A25-1321	1	
BIG BOSS 300 6X6 94	A25-1008	2	A25-1007	A25-1321	1
MAGNUM 325 2X4 00-01	A25-1129	2	A25-1322	1	
MAGNUM 325 2X4 02	A25-1129	2	0215-0078	1	
MAGNUM 325 4X4 00-01	A25-1008	2	A25-1006	A25-1322	1
MAGNUM 325 4X4 02	A25-1008	2	A25-1006	0215-0078	1
MAGNUM 325 4X4 HDS 01-02	0215-0078	2	0215-0078	1	
TRAIL BOSS 325 00-02	A25-1129	2	A25-1151	1	
XPEDITION 325 00-01	A25-1008	2	A25-1006	A25-1322	1
XPEDITION 325 02	A25-1008	2	A25-1006	0215-0078	1
ATP 330 4X4 04-05	0215-0078	2	0215-0078	1	
MAGNUM 330 2X4 03-05	A25-1129	2	0215-0078	1	
MAGNUM 330 4X4 03-05	0215-0078	2	0215-0078	1	
TRAIL BLAZER 330 08-09	0215-0160	2	A25-1151	1	
TRAIL BLAZER 330 10-13	0215-0078	2	A25-1151	1	
TRAIL BOSS 330 03-04	A25-1129	2	A25-1151	1	
TRAIL BOSS 330 05-09	0215-0160	2	A25-1151	1	
TRAIL BOSS 330 10-13	0215-0078	2	A25-1151	1	
SPORTSMAN 335 99-00	A25-1008	2	A25-1006	A25-1150	1
WORKER 335 99	A25-1008	2	A25-1006	A25-1150	1
350L 2X4 93	A25-1129	2	A25-1321	1	
350L 4X4 93	A25-1008	2	A25-1007	A25-1321	1
SPORTSMAN 350 4X4 93	A25-1008	2	A25-1007	A25-1321	1
TRAIL BOSS 350L 2X4 90-92	A25-1129	2	A25-1321	1	
TRAIL BOSS 350L 4X4 90-92	A25-1008	2	A25-1007	A25-1321	1
BIG BOSS 350L 6X6 93	A25-1008	2	A25-1007	A25-1321	1
400L 2X4 94-95	A25-1129	2	A25-1321	1	
400L 4X4 94	A25-1008	2	A25-1007	A25-1321	1
SPORTSMAN 400 4X4 94	A25-1008	2	A25-1007	A25-1321	1
SPORTSMAN 400 4X4 95-97	A25-1008	2	A25-1006	A25-1321	1
SPORTSMAN 400 4X4 01-03	A25-1008	2	A25-1006	A25-1150	1
SPORTSMAN 400 4X4 AA AE AG 04	A25-1008	2	A25-1006	A25-1150	1
SPORTSMAN 400 4X4 AQ-AV 04	0215-0078	2	A25-1150	1	
SPORTSMAN 400 4X4 05	0215-0078	2	A25-1150	1	
SPORTSMAN 400 HO 4X4 08-12	0215-0078	2	0215-0078	2	
TRAIL BLAZER 400 03	A25-1129	2	A25-1151	1	
XPLORER 400L 4X4 95-98	A25-1008	2	A25-1006	A25-1321	1
XPLORER 400L 4X4 99-02	A25-1008	2	A25-1006	A25-1151	1
XPRESS 400L 2X4 96-97	A25-1129	2	A25-1321	1	
BIG BOSS 400L 6X6 94	A25-1008	2	A25-1007	A25-1321	1
BIG BOSS 400L 6X6 95	A25-1008	2	A25-1321	1	
BIG BOSS 400L 6X6 96-97	A25-1008	2	A25-1006	A25-1321	1
MAGNUM 400L 6X6 96-97	A25-1008	2	A25-1006	A25-1321	1
MAGNUM 425 2X4 95-98	A25-1129	2	A25-1321	1	
MAGNUM 425 4X4 96	A25-1008	2	A25-1006	-	-

FITS MODEL	FRONT KIT PART #	FRONT STRUT KIT PART #	REAR KIT PART #	QTY	
WHEEL BEARING KITS (CON'T)					
POLARIS (CON'T)					
MAGNUM 425 4X4 98	A25-1008	2	A25-1006	A25-1321	1
XPEDITION 425 00-01	A25-1008	2	A25-1006	A25-1322	1
XPEDITION 425 02	A25-1008	2	A25-1006	0215-0078	1
SPORTSMAN 450 06-07	0215-0078	2	A25-1150	1	
DIESEL 455 4X4 99-01	A25-1008	2	A25-1006	A25-1150	1
ATP 500 4X4 04-05	0215-0078	2	-	0215-0078	1
MAGNUM 500 2X4 HDS 02	A25-1129	2	-	0215-0078	1
MAGNUM 500 4X4 99-01	A25-1008	2	A25-1006	A25-1322	1
MAGNUM 500 4X4 02	0215-0078	2	-	0215-0078	1
MAGNUM 500 4X4 HDS 01-03	0215-0078	2	-	0215-0078	1
SPORTSMAN 500 4X4 96-00	A25-1008	2	A25-1006	A25-1150	1
SPORTSMAN 500 4X4 HO 01-03	A25-1008	2	A25-1006	A25-1150	1
SPORTSMAN 500 4X4 HO AA-AC-AE-AG 04	A25-1008	2	A25-1006	A25-1150	1
SPORTSMAN 500 4X4 HO AD-AW 04	0215-0078	2	-	A25-1150	1
SPORTSMAN 500 4X4 HO 05-13	0215-0078	2	-	A25-1150	1
SPORTSMAN 500 4X4 RSE 99-02	A25-1008	2	A25-1006	A25-1150	1
SPORTSMAN 500 EFI 09-10	0215-0078	2	-	A25-1150	1
SPORTSMAN 500 HO 08-12	0215-0078	2	-	A25-1150	1
SPORTSMAN 500 X2 06-09	0215-0078	2	-	A25-1150	1
SPORTSMAN TOURING 500 EFI 08-13	0215-0078	2	-	A25-1150	1
XPLORER 500 97	A25-1008	2	A25-1006	A25-1150	1
BIG BOSS 500 6X6 98-99	A25-1008	2	A25-1006	A25-1321	1
BIG BOSS 500 6X6 00-03	A25-1008	2	A25-1006	A25-1151	1
SPORTSMAN 500 6X6 00-08	A25-1008	2	A25-1006	A25-1151	1
SPORTSMAN 550 EPS 10-13	0215-0738	2	-	0215-0738	2
SPORTSMAN 550 11-12	0215-0738	2	-	0215-0738	2
SPORTSMAN 550 X2 10-12	0215-0738	2	-	0215-0738	2
SPORTSMAN TOURING EPS 550 11-12	0215-0738	2	-	0215-0738	2
XP 550 BUILT AFTER 12/1/08 09	0215-0738	2	-	0215-0738	2
SPORTSMAN 600 4X4 03-05	0215-0078	2	-	A25-1150	1
SPORTSMAN 700 4X4 02-04	0215-0078	2	-	A25-1150	1
SPORTSMAN 700 TWIN 05-07	0215-0078	2	-	A25-1150	1
SPORTSMAN X2 700 TWIN EFI 08	0215-0078	2	-	A25-1150	1
SPORTSMAN 800 EFI 05-12	0215-0078	2	-	A25-1150	1
SPORTSMAN TOURING 800 EFI 08-09	0215-0078	2	-	A25-1150	1
SPORTSMAN X2 800 EFI 07-09	0215-0078	2	-	A25-1150	1
SPORTSMAN 800 EFI 6X6 09-12	0215-0078	2	-	A25-1150	1
SPORTSMAN TOURING EPS 850 10-12	0215-0738	2	-	0215-0738	1
SPORTSMAN X2 850 11-12	0215-0738	2	-	0215-0738	1
SPORTSMAN XP 850 09-13	0215-0738	2	-	0215-0738	1
SPORTSMAN XP 850 EPS 10-12	0215-0738	2	-	0215-0738	1
RANGER 4X4 400 10-13	0215-0078	2	-	A25-1150	1
RANGER 2X4 500 08-09	0215-0078	2	-	A25-1150	1
RANGER 4X4 500 04-08	0215-0078	2	-	A25-1150	1
RANGER 4X4 500 09-10	0215-0738	2	-	A25-1150	1
RANGER 4X4 500 99	A25-1008	2	A25-1006	-	-
RANGER 4X4 500 & 500 CREW 11-12	0215-0078	2	-	A25-1150	1
RANGER 4X4 700 05-08	0215-0078	2	-	A25-1150	1
RANGER 4X4 700 09	0215-0738	2	-	A25-1150	1
RANGER 4X4 700 CREW 08-09	0215-0078	2	-	A25-1150	1
RANGER 4X4 800 EFI, EFI CREW 10-12	0215-0738	2	-	A25-1150	1
RANGER 4X4 900 D 11	0215-0738	2	-	A25-1150	1
RANGER 4X4 CREW DIESEL 900 D 11-12	0215-0738	2	-	A25-1150	1
RANGER 6X6 500 02	A25-1008	2	-	-	-
RANGER 6X6 500 04	0215-0078	2	-	A25-1150	1
RANGER 6X6 700 EFI 06-09	0215-0078	2	-	A25-1150	1
RANGER 6X6 800 10-13	0215-0738	2	-	A25-1150	1
RANGER 900 13	0215-0738	2	-	A25-1150	1
RANGER SERIES 10 4X4 & 6X6 07	0215-0078	2	-	A25-1150	1
RANGER SERIES 11 4X4 & 6X6 07	0215-0078	2	-	A25-1150	1
RZR 4/EPS RGE 11	0215-0738	2	-	A25-1150	1
RZR 570 12-13	0215-0738	2	-	-	-
RZR S 800 09	0215-0418	2	-	A25-1150	1
RZR S 800 10-12	0215-0738	2	-	A25-1150	1
RZR 800 08-09	0215-0418	2	-	A25-1150	1
RZR 800 BUILT 12/31/09 AND BEFORE 10	0215-0418	2	-	A25-1150	1
RZR 800 BUILT 1/01/10 AND AFTER 10	0215-0738	2	-	A25-1150	1
RZR 800 11-12	0215-0738	2	-	A25-1150	1
RZR XP 900 11-12	0215-0738	2	-	0215-0738	2
SUZUKI					
LT-50 84-87	A25-1045	2	-	0215-0117	1
LT-A50 02-05	A25-1194	2	-	0215-0119	1
LT-Z50 06-09	A25-1194	2	-	0215-0119	1
LT-80 87-06	A25-1194	2	-	A25-1158	1
ALT-125 83-86	A25-1215	1	-	A25-1122	1

CONTINUED ON NEXT PAGE

FITS MODEL	FRONT KIT PART #	FRONT STRUT KIT PART #	REAR KIT PART #	QTY
WHEEL BEARING KITS (CON'T)				
SUZUKI (CON'T)				
LT-160 03-04	A25-1215	2 -	A25-1122	1
LT-160E 89-92	A25-1215	2 -	A25-1122	1
LT-F160 91-01	A25-1215	2 -	A25-1122	1
ALT-185F 85	A25-1215	1 -	A25-1122	1
LT-185 84-87	A25-1215	2 -	A25-1122	1
LT-230E 87-93	A25-1042	2 -	A25-1331	1
LT-230GE 85-86	A25-1043	2 -	A25-1149	1
LT-230S 85-88	A25-1042	2 -	A25-1331	1
LT-F230 86-87	A25-1043	2 -	A25-1149	1
LT-250EF 85-86	A25-1043	2 -	A25-1145	1
LT-250S 89-90	A25-1042	2 -	A25-1331	1
LT-4WD 250 87	A25-1108	2 -	-	-
LT-4WD 250 88-98	A25-1108	2 -	A25-1299	2
LT-F250 88-01	A25-1108	2 -	A25-1299	2
LT-F250 OZARK 02-12	A25-1215	2 -	0215-0154	1
LT-F250F (EXCEPT OZARK) 99-02	A25-1108	2 -	A25-1299	2
LT-F4WD 250 97-98	A25-1108	2 -	A25-1299	2
LT-300E 87-89	A25-1043	2 -	A25-1331	1
LT-F300F KING QUAD 99-02	A25-1108	2 -	A25-1299	2
LT-F4WD KING QUAD 300 91-98	A25-1108	2 -	A25-1299	2
LT-A, LT-F400 2WD KING QUAD 08-09	A25-1108	2 -	A25-1293	2
LT-A, LT-F400 EIGER 2WD 02-04	A25-1108	2 -	A25-1293	2
LT-A, LT-F400 EIGER 2WD 07	A25-1108	2 -	A25-1293	2
LT-A, LT-F400F 4WD KING QUAD 08-12	A25-1108	2 -	A25-1293	2
LT-A, LT-F400F EIGER 4WD 02-07	A25-1108	2 -	A25-1293	2
LTA-450 X KING QUAD 07-10	0215-0247	2 -	0215-0246	2
LT-A500F QUAD MASTER AUTO 00-01	A25-1108	2 -	A25-1293	2
LT-A500F VINSON 02-07	A25-1108	2 -	A25-1293	2
LT-A500X 09-12	0215-0247	2 -	0215-0246	2
LT-F500F QUAD MASTER 00-01	A25-1108	2 -	A25-1293	2
LT-F500F QUAD RUNNER 98-99	A25-1108	2 -	A25-1293	2
LT-F500F VINSON 02-07	A25-1108	2 -	A25-1293	2
LTA-700 X KING QUAD 05-07	0215-0247	2 -	0215-0246	2
LTV-700F TWIN PEAKS 04-06	0215-0157	2 -	-	-
LTA-750 X KING QUAD 08-12	0215-0247	2 -	0215-0246	2

YAMAHA				
YF60 84-85	A25-1009	1 -	A25-1404	1
YFM80 85-86	A25-1104	2 -	0215-0119	1
YFM80 87-88	A25-1052	2 -	0215-0119	1
YFM80 BADGER 92-01	A25-1052	2 -	-	-
YFM80 GRIZZLY 05-08	A25-1052	2 -	-	-
YFM100 87-88	A25-1052	2 -	0215-0119	1
YFM100 89-91	A25-1052	2 -	-	-
YFA1 91-04	A25-1052	2 -	A25-1314	1
YFM125 GRIZZLY 04-12	A25-1052	2 -	A25-1314	1
YTI-125 83-85	-	-	A25-1314	1
YTI-175 82-83	A25-1104	1 -	A25-1314	1
YFM200 MOTO-4 85-89	A25-1064	2 -	A25-1011	1
YTM200 EK, EL, ERN 83-85	-	-	A25-1011	1
YTM200L, N 84-85	A25-1104	1 -	-	-
YFM225 MOTO-4 86-88	A25-1064	2 -	A25-1011	1
YTM225 TRI-MOTO, DXK, DXL 83-86	A25-1104	1 -	A25-1011	1
YFB250 TIMBERWOLF 92-94	A25-1048	2 -	A25-1134	1
YFB250 TIMBERWOLF 95-98	A25-1044	2 -	A25-1134	1
YFB250FW TIMBERWOLF 94-00	A25-1108	2 -	A25-1134	1
YFM250 BEARTRACKER 99	A25-1226	2 -	0215-0120	1
YFM250 BEARTRACKER 00	A25-1226	2 -	A25-1139	1
YFM250 BEARTRACKER 01-04	A25-1044	2 -	A25-1139	1
YFM250 BIG BEAR 07-09	A25-1044	2 -	A25-1139	1
YFM250 MOTO-4 89-91	A25-1044	2 -	A25-1010	1
YFM250B BRUIN 05-06	A25-1044	2 -	A25-1139	1
YTZ250 TRI MOTO 85-86	-	-	A25-1315	1
YFM300 GRIZZLY 12-13	-	-	A25-1124	1
YFM350 GRIZZLY IRS 07-12	A25-1108	2 -	0215-0153 ¹	2
YFM350 RAPTOR 04-13	A25-1044	2 -	0215-0162	1
YFM350A, BA BRUIN 2WD 04-06	A25-1108	2 -	A25-1139	1
YFM350ER MOTO-4 87-89	A25-1064	2 -	A25-1010	1
YFM350ER MOTO-4 90-95	A25-1044	2 -	A25-1010	1
YFM350FA BRUIN 4WD 04-06	A25-1108	2 -	A25-1139	1
YFM350FEW GRIZZLY 4WD 07-12	A25-1108	2 -	A25-1139	1
YFM350FW BIG BEAR 87-95	A25-1108	2 -	A25-1010	1
YFM350FW BIG BEAR 96-99	A25-1108	2 -	0215-0120	1
YFM350GW GRIZZLY 2WD 07-11	A25-1108	2 -	A25-1139	1
YFM350U BIG BEAR 96-99	A25-1108	2 -	0215-0120	1
YFM400 BIG BEAR 2WD 00-04	A25-1108	2 -	A25-1139	1

FITS MODEL	FRONT KIT PART #	FRONT STRUT KIT PART #	REAR KIT PART #	QTY
WHEEL BEARING KITS (CON'T)				
YAMAHA (CON'T)				
YFM400 BIG BEAR 4WD 00-06	A25-1108	2 -	A25-1139	1
YFM400 BIG BEAR IRS 07-12	A25-1108	2 -	0215-0153 ¹	2
YFM400 GRIZZLY IRS 07-08	A25-1108	2 -	0215-0153 ¹	2
YFM400 KODIAK 2WD 00-01	A25-1108	2 -	A25-1012	1
YFM400 KODIAK 2WD 03-04	A25-1108	2 -	A25-1139	1
YFM400 KODIAK 4WD 93-99	A25-1108	2 -	A25-1015	1
YFM400 KODIAK 4WD 00-02	A25-1108	2 -	A25-1012	1
YFM400 KODIAK 4WD 03-04	A25-1108	2 -	A25-1139	1
YFM400 KODIAK 4WD 05-06	A25-1108	2 -	0215-0153 ¹	2
YFM450 GRIZZLY IRS 07-13	A25-1108	2 -	0215-0153 ¹	2
YFM450 KODIAK 03-04	A25-1108	2 -	A25-1012	1
YFM450 KODIAK 05-06	A25-1108	2 -	0215-0153 ¹	2
YFM550 GRIZZLY/EPS 09-13	0215-0153	2 -	0215-0153 ¹	2
YFM600 GRIZZLY 98	A25-1108	2 -	0215-0120	1
YFM600 GRIZZLY 99-01	A25-1108	2 -	A25-1139	1
YFM660 GRIZZLY 02	0215-0015	2 -	0215-0016	1
YFM660 GRIZZLY 03-08	0215-0153 ¹	2 -	0215-0153 ¹	2
YFM700 GRIZZLY EPS 08-13	0215-0153 ¹	2 -	0215-0153 ¹	2
RHINO 450 06-09	A25-1108	2 -	0215-0221	2
RHINO 660 04-07	A25-1108	2 -	0215-0221	2
RHINO 700 FI 08-11	A25-1108	2 -	0215-0221	2

¹NO SEALS INCLUDED

DIFFERENTIAL BEARINGS AND SEAL KITS > \$9.95-\$133.95

Kits include high-speed bearings that are premium-quality and use EMQ standard seals. Garter-spring inner lips and optimal sealing from rubber-covered outside diameter seals. Imported.



FITS MODEL	KIT FRONT PART #	SEAL KIT FRONT PART #	KIT REAR PART #	SEAL KIT REAR PART #
DIFFERENTIAL BEARINGS				
ARCTIC CAT				
250 4X4 01-02	A25-2022	0935-0416	-	-
250 4X4 03	1205-0001	-	-	-
300 4X4 98-01	A25-2022	0935-0416	-	-
300 4X4 02-03	1205-0001	-	-	-
300 4X4 04	1205-0181	0935-0471	-	-
366 FIS W/AT 08-11	1205-0181	0935-0471	1205-0181	0935-0471
375 4X4 W/AT 02	1205-0001	-	-	-
400 2X4 98-01	-	-	1205-0047	-
400 2X4 FIS W/AT 04	-	-	1205-0181	0935-0471
400 2X4 FIS W/MT 03	-	-	1205-0001	-
400 2X4 FIS W/MT 04	-	-	1205-0181	0935-0471
400 4X4 98-00	A25-2022	0935-0416	1205-0047	-
400 4X4 W/AT 03	1205-0001	-	-	-
400 4X4 W/MT 01	A25-2022	0935-0416	1205-0047	-
400 4X4 W/MT 02-03	1205-0001	-	-	-
400 FIS 4X4 TRV 09-11	1205-0182	0935-0472	1205-0181	0935-0471
400 FIS 4X4 W/AT 03	1205-0001	-	1205-0001	-
400 FIS 4X4 W/AT 04	-	-	1205-0181	0935-0471
400 FIS 4X4 W/AT 05-08	1205-0182	0935-0472	1205-0181	0935-0471
400 FIS 4X4 W/MT 02-03	1205-0001	-	1205-0001	-
400 FIS 4X4 W/MT 04	-	-	1205-0181	-
400 FIS 4X4 W/MT 05-08	1205-0182	0935-0472	1205-0181	0935-0471
400 TBX 4X4 04	-	-	1205-0181	0935-0471
400 TBX 4X4 05-06	1205-0181	0935-0471	1205-0181	0935-0471
400 TRV 07	1205-0181	0935-0471	1205-0181	0935-0471
400 VP 4X4 06	1205-0181	0935-0471	-	-
425 UTILITY 4X4 11	-	0935-0472	-	0935-0471
425I 4X4 12	-	0935-0472	-	0935-0471
450 H1 10-11	1205-0182	0935-0472	1205-0181	0935-0471
450I EFI 12	1205-0182	0935-0472	1205-0181	0935-0471
450I TRV EFI 12	1205-0182	0935-0472	1205-0181	0935-0471
454 2X4 97-98	-	-	1205-0047	-
454 4X4 96-98	A25-2022	0935-0416	1205-0047	-
500 4X4 98-99	A25-2022	0935-0416	1205-0047	-
500 4X4 W/AT 00-01	A25-2022	0935-0416	1205-0047	-
500 4X4 W/AT 02	1205-0001	-	-	-
500 4X4 W/MT 00-01	A25-2022	0935-0416	1205-0047	-

CONTINUED ON NEXT PAGE

FITS MODEL	KIT FRONT PART #	SEAL KIT FRONT PART #	KIT REAR PART #	SEAL KIT REAR PART #
DIFFERENTIAL BEARINGS (CON'T)				
ARCTIC CAT (CON'T)				
500 FIS 4X4 W/AT 02-03	1205-0001	-	1205-0001	-
500 FIS 4X4 W/AT 04	-	-	1205-0181	0935-0471
500 FIS 4X4 W/AT 05-09	1205-0182	0935-0472	1205-0181	0935-0471
500 FIS 4X4 W/MT 02	1205-0001	-	1205-0001	-
500 FIS 4X4 W/MT 04	-	-	1205-0181	0935-0471
500 FIS 4X4 W/MT 05-09	1205-0182	0935-0472	1205-0181	0935-0471
500 FIS TBX 4X4 02	1205-0001	-	-	-
500 FIS TBX 4X4 03	1205-0001	-	1205-0001	-
500 FIS TBX 4X4 04	-	-	1205-0181	0935-0471
500 FIS TBX 4X4 05-06	1205-0182	0935-0472	1205-0181	0935-0471
500 FIS TRV 4X4 03	1205-0001	-	1205-0001	-
500 FIS TRV 4X4 04	-	-	1205-0181	0935-0471
500 FIS TRV 4X4 05-06	1205-0182	0935-0472	1205-0181	0935-0471
500 FIS TRV 4X4 08	1205-0181	0935-0471	1205-0181	0935-0471
550 GT EFI 4X4 12	1205-0182	0935-0472	1205-0181	0935-0471
550 HI FIS 4X4 09-11	1205-0182	0935-0472	1205-0181	0935-0471
550 I EFI 4X4 12	1205-0182	0935-0472	1205-0181	0935-0471
550 TRV 4X4 W/AT 09-11	1205-0182	0935-0472	1205-0181	0935-0471
550I TRV GT EFI 4X4 12	1205-0182	0935-0472	1205-0181	0935-0471
650 4X4 HI 05-09	1205-0182	0935-0472	1205-0181	0935-0471
650 4X4 HI, 650 4X4 HI MUD PRO 10-11	1205-0182	0935-0472	1205-0181	0935-0471
650 4X4 W/AT V2 04-06	1205-0182	0935-0472	1205-0181	0935-0471
650I 4X4 12	1205-0182	0935-0472	1205-0181	0935-0471
700 DIESEL 08-11	1205-0182	0935-0472	1205-0181	0935-0471
700 EFI 4X4 07-12	1205-0182	0935-0472	1205-0181	0935-0471
700 EFI HI MUDPRO 09-12	1205-0182	0935-0472	1205-0181	0935-0471
700 EFI HI W/AT 08-11	1205-0182	0935-0472	1205-0181	0935-0471
700 GT EFI 12	1205-0182	0935-0472	1205-0181	0935-0471
700 HI TRV 08-11	1205-0182	0935-0472	1205-0181	0935-0471
700I TRV GT EFI 12	1205-0182	0935-0472	1205-0181	0935-0471
1000I GT 12	1205-0182	0935-0472	1205-0209	0935-0482
H2 MUDPRO 10-11	1205-0182	0935-0472	1205-0209	0935-0482
H2 THUNDERCAT 08-11	1205-0182	0935-0472	1205-0209	0935-0482
550 PROWLER XT 09-12	1205-0182	0935-0471	1205-0181	0935-0471
650 PROWLER XT 06-09	1205-0182	0935-0471	1205-0181	0935-0471
700 PROWLER HDX 12	1205-0182	0935-0471	1205-0181	0935-0471
700 PROWLER TX 08-12	1205-0182	0935-0471	1205-0181	0935-0471
1000 PROWLER XT 11-12	1205-0182	0935-0471	1205-0209	0935-0482
PROWLER H2 1000 XTZ 09-11	1205-0182	0935-0471	-	0935-0482
CAN-AM				
OUTLANDER 330 04-05	1205-0192	0935-0479	1205-0192	0935-0479
OUTLANDER 400 03-05	1205-0192	0935-0479	1205-0192	0935-0479
OUTLANDER 400 06-11	1205-0192	0935-0479	1205-0191	0935-0478
OUTLANDER 400 12	1205-0192	0935-0479	-	-
OUTLANDER 500 07-11	1205-0192	0935-0479	1205-0191	0935-0478
OUTLANDER 500 PSTEERING 10-11	1205-0192	0935-0479	1205-0191	0935-0478
OUTLANDER 500 P 12	1205-0192	0935-0479	-	-
RENEGADE 500 08-11	1205-0192	0935-0479	1205-0191	0935-0478
RENEGADE 500 PSTEERING 12	1205-0192	0935-0479	-	-
TRAXTER 500 99-04	-	0935-0479	-	-
TRAXTER 500 05	1205-0192	0935-0479	-	-
OUTLANDER 650 07-09	1205-0192	0935-0479	1205-0191	0935-0478
OUTLANDER 650 PSTEERING 10-11	1205-0192	0935-0479	1205-0191	0935-0478
OUTLANDER 650 PSTEERING 12	1205-0192	0935-0479	-	-
QUEST 650 02-04	1205-0192	0935-0479	-	-
TRAXTER 650 04-05	1205-0192	0935-0479	-	-
OUTLANDER 800 06-11	1205-0192	0935-0479	1205-0191	0935-0478
OUTLANDER 800 12	1205-0192	0935-0479	-	-
OUTLANDER 800 PSTEERING 10-11	1205-0192	0935-0479	1205-0191	0935-0478
OUTLANDER 800 PSTEERING 12-13	1205-0192	0935-0479	-	-
OUTLANDER STD XT 800 12	1205-0192	0935-0479	-	-
RENEGADE 800 07-10	1205-0192	0935-0479	1205-0191	0935-0478
RENEGADE 800 PSTEERING 10	1205-0192	0935-0479	1205-0191	0935-0478
RENEGADE 800 XXC 12	1205-0192	0935-0479	-	-
RENEGADE 800 PSTEERING 11	1205-0192	0935-0479	1205-0191	0935-0478
OUTLANDER STD XT 1000 12	1205-0192	0935-0479	-	-
RENEGADE 1000 XXC 12	1205-0192	0935-0479	-	-
COMMANDER 800 11-13	1205-0192	0935-0479	-	-
COMMANDER 1000 11-13	1205-0192	0935-0479	-	-
HONDA				
ATC200ES 84	-	-	A25-2007	-
TRX200 84	-	-	A25-2007	-
ATC250ES 85-87	-	-	A25-2008	0935-0409
ATC250SX 85-87	-	-	A25-2008	0935-0409

FITS MODEL	KIT FRONT PART #	SEAL KIT FRONT PART #	KIT REAR PART #	SEAL KIT REAR PART #
DIFFERENTIAL BEARINGS (CON'T)				
HONDA (CON'T)				
TRX250 FOURTRAX 85-87	-	-	A25-2008	0935-0409
TRX250 RECON 97-12	-	-	A25-2009	0935-0410
TRX300 FOURTRAX 300 88-00	-	-	A25-2010	0935-0411
TRX300FW FOURTRAX 4X4 88-00	A25-2001	0935-0406	A25-2010	0935-0411
TRX350FE 00-06	A25-2003	0935-0407	A25-2012	0935-0412
TRX350FM FOURTRAX RANCHER 00-06	A25-2003	0935-0407	A25-2012	0935-0412
TRX350TE 00-06	-	-	A25-2012	0935-0412
TRX350TM FOURTRAX RANCHER 00-06	-	-	A25-2012	0935-0412
TRX400FA 04-07	-	-	A25-2012	0935-0412
TRX400FGA FOURTRAX RANCHER 4X4 04-07	-	-	A25-2012	0935-0412
TRX400FW FOURTRAX FOREMAN 4X4 95-01	A25-2004	0935-0408	A25-2013	0935-0413
TRX400FW FOURTRAX FOREMAN 4X4 02-03	A25-2006	0935-0467	A25-2014	0935-0414
TRX420 FA 09-12	1205-0200	0935-0481	1205-0188	0935-0477
TRX420 FE/FM 07-13	1205-0200	0935-0481	1205-0199	0935-0480
TRX420 FPA 09-13	1205-0200	0935-0481	1205-0188	0935-0477
TRX420 FPE 11-13	1205-0200	0935-0481	1205-0199	0935-0480
TRX420 FPM 11-13	1205-0200	0935-0481	1205-0199	0935-0480
TRX420 TE/TM 07-10	-	-	1205-0199	0935-0480
TRX450ES 98-01	A25-2004	0935-0408	A25-2013	0935-0413
TRX450S 98-01	A25-2004	0935-0408	A25-2013	0935-0413
TRX500FA 01-04	A25-2006	0935-0467	A25-2014	0935-0414
TRX500FA 05-12	1205-0127	0935-0474	1205-0128	0935-0475
TRX500FE 12	1205-0215	-	1205-0216	-
TRX500FGA 04	A25-2006	0935-0474	A25-2014	0935-0414
TRX500FGA 05-09	1205-0127	0935-0474	1205-0128	0935-0475
TRX450FE/FM 02-04	A25-2006	0935-0467	A25-2014	0935-0414
TRX500FM 05-11	1205-0127	0935-0474	1205-0128	0935-0475
TRX500FM 12	1205-0215	-	1205-0216	-
TRX500FPA 09-12	1205-0127	0935-0474	1205-0128	0935-0475
TRX500FPE 08-11	1205-0127	0935-0474	1205-0128	0935-0475
TRX500FPE 12	1205-0215	-	1205-0216	-
TRX500FPM 08-11	1205-0127	0935-0474	1205-0128	0935-0475
TRX500FPM 12	1205-0215	-	1205-0216	-
TRX500TM 05-06	-	-	1205-0128	0935-0475
TRX650 RINCON 03-05	1205-0127	0935-0474	1205-0125	0935-0420
TRX680 RINCON 06-13	1205-0127	0935-0474	1205-0125	0935-0420
KAWASAKI				
KLF220 BAYOU 88-02	-	-	A25-2018	-
KLF250 BAYOU 03-11	-	-	A25-2018	-
KLF300B BAYOU 88-04	-	-	A25-2038	-
KLF300C BAYOU 4X4 89-04	A25-2015	-	A25-2020	0935-0468
KVF300A PRAIRIE 4X4 99-02	A25-2016	-	A25-2021	0935-0415
KVF300B PRAIRIE 2X4 99-02	-	-	A25-2021	0935-0415
KVF360A & C PRAIRIE 4X4 03-12	1205-0187	0935-0422	1205-0152	-
KVF360B PRAIRIE 03-10	-	-	1205-0152	-
KLF400 BAYOU 93-99	A25-2015	-	A25-2020	0935-0468
KVF400A PRAIRIE 4X4 97-98	A25-2016	-	A25-2021	0935-0415
KVF400B PRAIRIE 98	-	-	A25-2021	0935-0415
KVF400C PRAIRIE 4X4 99-02	A25-2016	-	A25-2021	0935-0415
KVF400D PRAIRIE 99-02	-	-	A25-2021	0935-0415
KVF650 BRUTE FORCE 05-11	1205-0187	0935-0422	1205-0152	0935-0476
KVF650 I BRUTE FORCE 06-12	1205-0187	0935-0422	-	-
KVF650 PRAIRIE 02-03	1205-0187	0935-0422	1205-0152	0935-0476
KFX 700 V-FORCE 04-09	-	-	1205-0152	0935-0476
KVF700 PRAIRIE 04-06	1205-0187	0935-0422	1205-0152	0935-0476
KVF750 BRUTE FORCE 05-13	1205-0187	0935-0422	-	-
POLARIS				
XPLORER 250 4X4 00-02	1205-0162	-	-	-
MAGNUM 325 2X4 00-02	-	-	1205-0164	0935-0473
MAGNUM 325 4X4 00-02	-	-	1205-0164	0935-0473
MAGNUM 325 4X4 HDS 01-02	-	-	1205-0164	0935-0473
XPEDITION 325 00-02	-	-	1205-0164	0935-0473
ATP 330 4X4 04-05	1205-0167	0935-0421	-	-
MAGNUM 330 2X4 03-05	-	-	1205-0165	-
MAGNUM 330 4X4 03-05	1205-0167	0935-0421	1205-0165	-
SPORTSMAN 335 99-00	1205-0162	-	-	-
SPORTSMAN 400 4X4 01-03	1205-0162	-	-	-
SPORTSMAN 400 4X4 05	1205-0167	0935-0421	-	-
SPORTSMAN 400 4X4 AA AE AG 04	1205-0162	-	-	-
SPORTSMAN 400 4X4 AQ-AV 04	1205-0167	0935-0421	-	-
XPLORER 400L 4X4 99-02	1205-0162	-	-	-
XPEDITION 425 00-02	-	-	1205-0164	0935-0473
SPORTSMAN 450 06	1205-0167	0935-0421	-	-
DIESEL 455 4X4 00-01	1205-0162	-	-	-

CONTINUED ON NEXT PAGE

PLOWS
WINCHES
UTV
RACKS
LUGGAGE
BODY
CONTROLS
ELECTRICAL
WHEELS & TIRES
SUSPENSION & DRIVE
ENGINE
NRA BY MODEL
RIDER
TOWING
GARAGE
PROMO

FITS MODEL	KIT FRONT PART #	SEAL KIT FRONT PART #	KIT REAR PART #	SEAL KIT REAR PART #
DIFFERENTIAL BEARINGS (CON'T)				
POLARIS (CON'T)				
DIESEL 455 4X4 (AFTER 9/98) 99	1205-0162	-	-	-
MAGNUM 500 2X4 HDS 02	-	-	1205-0164	0935-0473
MAGNUM 500 4X4 99-01	-	-	1205-0164	0935-0473
MAGNUM 500 4X4 02	1205-0167	0935-0421	1205-0164	0935-0473
MAGNUM 500 4X4 HDS 01-02	-	-	1205-0164	0935-0473
MAGNUM 500 4X4 HDS 03	-	-	1205-0165	-
SCRAMBLER 500 4X4 99-09	1205-0162	-	-	-
SPORTSMAN 500 4X4 00	1205-0162	-	-	-
SPORTSMAN 500 4X4 (AFTER 9/98) 99	1205-0162	-	-	-
SPORTSMAN 500 4X4 HO 01-03	1205-0162	-	-	-
SPORTSMAN 500 4X4 HO 05-06	1205-0167	0935-0421	-	-
SPORTSMAN 500 4X4 HO AA- AC- AE- AG 04	1205-0162	-	-	-
SPORTSMAN 500 4X4 HO AD-AW 04	1205-0167	0935-0421	-	-
SPORTSMAN 550 12	1205-0213	-	-	-
SPORTSMAN 550 EPS 10	1205-0213	-	-	-
SPORTSMAN 550 EPS 12	1205-0213	-	-	-
SPORTSMAN 550 X2 10-12	1205-0213	-	-	-
SPORTSMAN 550 EPS 11	1205-0213	-	-	-
SPORTSMAN TOURING EPS 550 11-12	1205-0213	-	-	-
XP 550 09	1205-0213	-	-	-
SPORTSMAN 600 4X4 03-04	1205-0167	0935-0421	1205-0164	0935-0473
SPORTSMAN 600 4X4 05	1205-0167	0935-0421	1205-0165	-
SPORTSMAN 700 4X4 02-04	1205-0167	0935-0421	1205-0164	0935-0473
SPORTSMAN 700 TWIN 07	-	0935-0421	1205-0165	-
SPORTSMAN 700 TWIN EFI 07	-	-	1205-0165	-
SPORTSMAN 700 TWIN EFI 05-06	1205-0167	0935-0421	1205-0165	-
SPORTSMAN MV7 05	1205-0167	0935-0421	1205-0165	-
SPORTSMAN X2 700 TWIN EFI 08	1205-0167	0935-0421	-	-
SPORTSMAN 800 EFI 05-06	1205-0167	0935-0421	1205-0165	-
SPORTSMAN 800 EFI 07	-	0935-0421	1205-0165	-
SPORTSMAN 800 EFI 08	-	-	1205-0165	-
SPORTSMAN TOURING EPS 850 10-12	1205-0213	-	-	-
SPORTSMAN X2 850 11	1205-0213	-	-	-
SPORTSMAN XP 850 09-12	1205-0213	-	-	-
BIG BOSS 500 6X6 01-03	1205-0162	-	-	-
RANGER 4X4 500 04-08	1205-0167	0935-0421	-	-
RANGER 6X6 500 02	1205-0167	0935-0421	-	-
RANGER 6X6 500 04	1205-0167	0935-0421	-	-
SPORTSMAN 500 6X6 00-08	1205-0162	-	-	-
RANGER 4X4 700 05-08	1205-0167	0935-0421	-	-
RANGER 4X4 700 CREW 08-09	1205-0167	0935-0421	-	-
RANGER 6X6 700 EFI 06-09	1205-0167	0935-0421	-	-
RANGER 4X4 CREW DIESEL 900 11-12	1205-0212	-	-	-
RZR 570 EFI 12	1205-0212	-	-	-
RZR 4/EPS RGE 11	1205-0212	-	-	-
RZR S 800 09-10	1205-0214	-	-	-
RZR S 800 11-12	1205-0212	-	-	-
RZR 800 08-09	1205-0214	-	-	-
RZR 800 11	1205-0214	-	-	-
RZR 800 12	1205-0212	-	-	-
RZR 800 10	1205-0214	-	-	-
RZR XP 900 11-12	1205-0212	-	-	-
SUZUKI				
LT-4WD 250 87-98	A25-2022	0935-0416	-	-
LT-F250 OZARK 02-12	-	-	1205-0126	-
LT-F250F 99-02	A25-2022	0935-0416	-	-
LT-F4WD 250 97-98	A25-2022	0935-0416	-	-
LT-Z250 04-09	-	-	1205-0126	-
LT-F300F KING QUAD 99-02	A25-2022	0935-0416	-	-
LT-F4WDX KING QUAD 300 91-98	A25-2022	0935-0416	-	-
LT-A500F QUAD MASTER AUTO 00	A25-2022	0935-0416	1205-0047	-
LT-A500F QUAD MASTER AUTO 01	A25-2022	0935-0416	-	-
LT-F500F QUAD MASTER 00	A25-2022	0935-0416	1205-0047	-
LT-F500F QUAD MASTER 01	A25-2022	0935-0416	-	-
LT-F500F QUAD RUNNER 98-99	A25-2022	0935-0416	1205-0047	-
LT-F500F VINSON 02	A25-2022	0935-0416	-	-
LTV-700F TWIN PEAKS 04-06	1205-0187	0935-0422	1205-0152	0935-0476
YAMAHA				
YFM200 MOTO-4 85-89	-	-	A25-2030	0935-0417
YTM200 EK 83	-	-	A25-2030	0935-0417
YTM200 EL 84	-	-	A25-2030	0935-0417
YTM200 ERN 85	-	-	A25-2030	0935-0417
YTM200 K 83	-	-	A25-2030	0935-0417
YFM225 MOTO-4 86-88	-	-	A25-2030	0935-0417

FITS MODEL	KIT FRONT PART #	SEAL KIT FRONT PART #	KIT REAR PART #	SEAL KIT REAR PART #
DIFFERENTIAL BEARINGS (CON'T)				
YAMAHA (CON'T)				
YTM225 TRI-MOTO 85-86	-	-	A25-2030	0935-0417
YTM225 TRI-MOTO 83-84	-	-	A25-2030	0935-0417
YFB250 TIMBERWOLF 92-98	-	-	A25-2030	0935-0417
YFB250FW TIMBERWOLF 94-00	A25-2026	-	A25-2030	0935-0417
YFM250 BEARTRACKER 99-04	-	-	A25-2033	0935-0418
YFM250 BIG BEAR 07-09	-	-	A25-2033	0935-0418
YFM250 MOTO-4 89-91	-	-	A25-2030	0935-0417
YFM250B BRUIN 05-06	-	-	A25-2033	0935-0418
YFM350 GRIZZLY IRS 07-11	1205-0210	-	-	-
YFM350A BRUIN 2WD 04	-	-	A25-2033	0935-0418
YFM350BA BRUIN 2WD 05-06	-	-	A25-2033	0935-0418
YFM350ER MOTO-4 87-95	-	-	A25-2030	0935-0417
YFM350FA BRUIN 4WD 04-06	A25-2028	0935-0469	A25-2033	0935-0418
YFM350FGW GRIZZLY 4WD 07-08	A25-2028	0935-0469	A25-2033	0935-0418
YFM350FGW GRIZZLY 4WD 09-12	A25-2028	-	A25-2033	0935-0418
YFM350FW BIG BEAR 87-95	A25-2026	-	A25-2030	0935-0417
YFM350FW BIG BEAR 96-97	A25-2026	-	A25-2033	0935-0418
YFM350FW BIG BEAR 98-99	A25-2001	0935-0406	A25-2033	0935-0418
YFM350GW GRIZZLY 2WD 07-11	-	-	A25-2033	0935-0418
YFM350U BIG BEAR 96-99	-	-	A25-2033	0935-0418
YFM350FX WOLVERINE 95-97	-	-	A25-2033	0935-0418
YFM350FX WOLVERINE 98-99	A25-2001	0935-0406	A25-2033	0935-0418
YFM350FX WOLVERINE 00-05	A25-2001	0935-0406	A25-2033	0935-0418
YFM35X WOLVERINE 06-09	-	-	A25-2033	0935-0418
YFM400 BIG BEAR 2WD 00-04	-	-	A25-2033	0935-0418
YFM400 BIG BEAR 4WD 00-01	A25-2001	0935-0406	A25-2033	0935-0418
YFM400 BIG BEAR 4WD 02-06	A25-2028	0935-0469	A25-2033	0935-0418
YFM400 BIG BEAR IRS 07-12	1205-0210	-	-	-
YFM400 GRIZZLY IRS 07-08	A25-2028	0935-0469	-	-
YFM400 KODIAK 2WD 00-01	-	-	A25-2033	0935-0418
YFM400 KODIAK 2WD 03-04	-	-	A25-2033	0935-0418
YFM400 KODIAK 4WD 93-98	A25-2026	-	A25-2033	0935-0418
YFM400 KODIAK 4WD 99	A25-2001	0935-0406	A25-2033	0935-0418
YFM400 KODIAK 4WD 00-04	A25-2028	0935-0469	A25-2033	0935-0418
YFM400 KODIAK 4WD 05-06	A25-2028	0935-0469	-	-
YFM450 GRIZZLY IRS 07	1205-0122	0935-0419	-	-
YFM450 GRIZZLY IRS 08-12	1205-0210	-	-	-
YFM450 KODIAK 03-04	1205-0122	0935-0419	A25-2033	0935-0418
YFM450 KODIAK 05-06	1205-0122	0935-0419	-	-
YFM450FX WOLVERINE 4X4 06-10	A25-2028	0935-0469	A25-2033	0935-0418
YFM550 GRIZZLY EPS 09-12	1205-0210	-	1205-0211	-
YFM600 GRIZZLY 98-01	-	-	A25-2033	0935-0418
YFM600 GRIZZLY 02	1205-0122	0935-0419	1205-0123	0935-0470
YFM660 GRIZZLY 02-08	1205-0122	0935-0419	1205-0123	0935-0470
YFM700 GRIZZLY 07-13	1205-0210	-	1205-0211	-
RHINO 450 06-09	1205-0122	-	1205-0123	-
RHINO 660 04-07	1205-0122	-	1205-0123	-
RHINO 700 FI 08-13	1205-0210	-	1205-0123	-



INDEPENDENT REAR SUSPENSION KITS > \$39.95-\$109.95

Cost-effective kit containing all of the parts required to rebuild one side of an ATV rear suspension. Includes all bearings, bushings, seals, shafts and all components to repair the rear upper and lower a-arm and knuckle. Two kits required per vehicle. Imported.

FITS MODEL	REAR SUSPENSION KIT PART #	KNUCKLE KIT ONLY PART #
INDEPENDENT REAR SUSPENSION KITS		
ARCTIC CAT		
400 2X4 FIS W/AT 03	0430-0625	-
400 2X4 FIS W/AT 04	0430-0624	-
400 2X4 FIS W/MT 03	0430-0625	-
400 FIS 4X4 TRV 09-13	0430-0624	-
400 FIS 4X4 W/AT 03	0430-0625	-
400 FIS 4X4 W/AT 04-08	0430-0624	-
400 FIS 4X4 W/MT 02-03	0430-0625	-

CONTINUED ON NEXT PAGE

FITS MODEL	REAR SUSPENSION KIT PART #	KNUCKLE KIT ONLY PART #
INDEPENDENT REAR SUSPENSION KITS (CON'T)		
ARCTIC CAT (CON'T)		
400 FIS 4X4 W/MT 04-08	0430-0624	-
400 TBX 4X4 04	0430-0625	-
400 TBX 4X4 05-06	0430-0624	-
450 HI 11	0430-0624	-
450I EFI 12	0430-0624	-
450I TRV EFI 12	0430-0624	-
500 FIS 4X4 W/AT 02-03	0430-0625	-
500 FIS 4X4 W/AT 04-09	0430-0624	-
500 FIS 4X4 W/MT 02	0430-0625	-
500 FIS 4X4 W/MT 04-09	0430-0624	-
500 FIS TBX 4X4 03-04	0430-0625	-
500 FIS TBX 4X4 05-06	0430-0624	-
500 FIS TRV 4X4 03-04	0430-0625	-
500 FIS TRV 4X4 05-06	0430-0624	-
500 FIS TRV 4X4 08	0430-0624	-
550 GT EFI 4X4 12	0430-0624	-
550 HI FIS 4X4 09-11	0430-0624	-
550 I EFI 4X4 12-13	0430-0624	-
550 TRV 4X4 W/AT 09-11	0430-0624	-
550I TRV GT EFI 4X4 12	0430-0624	-
650 4X4 HI 05-09	0430-0624	-
650 4X4 HI, 650 4X4 HI MUD PRO 10-11	0430-0624	-
650 4X4 W/AT V2 04-06	0430-0624	-
650I 4X4 12	0430-0624	-
700 DIESEL 08-13	0430-0624	-
700 EFI 4X4 07-13	0430-0624	-
700 EFI HI MUDPRO 09-12	0430-0624	-
700 EFI HI W/AT 08-11	0430-0624	-
700 GT EFI 12	0430-0624	-
700 HI TRV 08-11	0430-0624	-
700I TRV GT EFI 12-13	0430-0624	-
1000I GT 12	0430-0624	-
H2 MUDPRO 10-11	0430-0624	-
H2 THUNDERCAT 08-11	0430-0624	-
550 PROWLER XT 12-13	0430-0624	-
700 PROWLER HDX 12	0430-0624	-
700 PROWLER TX 12	0430-0624	-
1000 PROWLER XTZ 12-13	0430-0624	-
CAN-AM		
OUTLANDER 330 04-05	0430-0603	-
OUTLANDER 400 03-13	0430-0603	-
OUTLANDER 500 07-13	0430-0603	-
RENEGADE 500 08-12	0430-0603	-
RENEGADE 500 13	0430-0681	-
OUTLANDER 650 07-12	0430-0603	-
OUTLANDER 650 13	0430-0681	-
OUTLANDER 800 06-12	0430-0603	-
OUTLANDER 800 13	0430-0681	-
OUTLANDER STD XT 800 12	0430-0681	-
RENEGADE 800 07-10	0430-0603	-
RENEGADE 800 PSTEERING 10	0430-0603	-
RENEGADE 800 XXC 12-13	0430-0681	-
RENEGADE 800 PSTEERING 11	0430-0603	-
OUTLANDER STD XT 1000 12	0430-0681	-
RENEGADE 1000 XXC 12	0430-0681	-
COMMANDER 800 11-13	0430-0680	-
COMMANDER 1000 11-13	0430-0680	-
HONDA		
TRX420FA 09-13	0430-0602	-
TRX650 RINCON 03-05	0430-0322	0430-0617
TRX680 RINCON 06-13	0430-0322	0430-0617
KAWASAKI		
KVF650 I BRUTE FORCE 06-13	0430-0461	0430-0619
KVF750 BRUTE FORCE 05-11	0430-0461	0430-0619
KVF750 BRUTE FORCE EPS 12-13	0430-0461	0430-0619
TERYX 750 4X4 08-13	-	0430-0619
POLARIS		
HAWKEYE 2X4 06-07	0430-0676	-
HAWKEYE 4X4 06-07	0430-0676	-
SPORTSMAN 300 4X4 08-10	0430-0676	-
SPORTSMAN 335 99-00	0430-0622	-
SPORTSMAN 400 4X4 01-02	0430-0622	-
SPORTSMAN 400 4X4 03-04	0430-0620	-
SPORTSMAN 400 4X4 05	0430-0620	-

FITS MODEL	REAR SUSPENSION KIT PART #	KNUCKLE KIT ONLY PART #
INDEPENDENT REAR SUSPENSION KITS (CON'T)		
POLARIS (CON'T)		
SPORTSMAN 400 HO 4X4 09-10	0430-0676	-
SPORTSMAN 400 HO 4X4 11-13	0430-0620	-
SPORTSMAN 400 HO 4X4 08	0430-0676	-
SPORTSMAN 450 06-07	0430-0620	-
SPORTSMAN 500 4X4 96-99	0430-0622	-
SPORTSMAN 500 4X4 00	0430-0622	-
SPORTSMAN 500 4X4 HO 01-13	0430-0620	-
SPORTSMAN 500 4X4 HO 04	0430-0620	-
SPORTSMAN 500 EFI 09-12	0430-0620	-
SPORTSMAN 500 X2 06-07	0430-0621	-
SPORTSMAN 500 X2 08-09	0430-0623	-
SPORTSMAN TOURING 500 EFI 08-11	0430-0620	-
SPORTSMAN TOURING 500 EFI 12-13	0430-0623	-
XPLORER 500 97	0430-0622	-
SPORTSMAN 600 4X4 03-05	0430-0620	-
SPORTSMAN 700 4X4 02-07	0430-0620	-
SPORTSMAN X2 700 TWIN EFI 08	0430-0623	-
SPORTSMAN 800 EFI 05-13	0430-0620	-
SPORTSMAN TOURING 800 EFI 08-09	0430-0623	-
SPORTSMAN X2 800 EFI 07	0430-0621	-
SPORTSMAN X2 800 EFI 08-09	0430-0623	-
RANGER 4X4 400 10-12	0430-0626	-
RANGER 2X4 500 08-09	0430-0626	-
RANGER 4X4 500 04-09	0430-0626	-
RANGER 4X4 500 10-12	0430-0626	-
RANGER 4X4 500 CREW 11-12	0430-0626	-
RANGER 4X4 700 05-09	0430-0626	-
RANGER 6X6 700 EFI 08-09	0430-0626	-
RANGER 4X4 800 EFI 10-13	0430-0626	-
RANGER 6X6 800 10-13	0430-0626	-
RANGER XP 800 12-13	0430-0626	-
RANGER 4X4 CREW DIESEL 900 11	0430-0626	-
RANGER 4X4 DIESEL 900 11-13	0430-0626	-
RANGER 900 XP 13	0430-0682	-
RZR 570 EFI 12	0430-0682	-
RZR 800 4/EPS RGE 11	0430-0679	-
RZR S 800 09-12	0430-0679	-
RZR 800 08-12	0430-0679	-
SUZUKI		
LTA-450 X KING QUAD 07	0430-0460	0430-0618
LTA-450 X KING QUAD 08-10	0430-0564	0430-0675
LT-A500X 09-12	0430-0677	0430-0678
LTA-700 X KING QUAD 05-07	0430-0460	0430-0618
LTA-750 X KING QUAD 08-12	0430-0677	0430-0678
YAMAHA		
YFM350 GRIZZLY IRS 07-11	0430-0310	0430-0616
YFM400 BIG BEAR IRS 07-12	0430-0310	0430-0616
YFM400 GRIZZLY IRS 07-08	0430-0310	0430-0616
YFM450 GRIZZLY IRS 07-13	0430-0310	0430-0616
YFM450 KODIAK 05-06	0430-0310	0430-0616
YFM550 GRIZZLY 09-13	0430-0310	0430-0616
YFM600 GRIZZLY 02	0430-0310	0430-0616
YFM660 GRIZZLY 02-08	0430-0310	0430-0616
YFM700 GRIZZLY 07-13	0430-0310	0430-0616
RHINO 450 06-09	0430-0310	0430-0616
RHINO 660 04-07	0430-0310	0430-0616
RHINO 700 FI 08-13	0430-0310	0430-0616

PLOWS
WINCHES
UTV
RACKS
LUGGAGE
BODY
CONTROLS
ELECTRICAL
WHEELS & TIRES
SUSPENSION & DRIVE
ENGINE
NRA BY MOOSE
RIDER
TOWING
GARAGE
PROMO



FRONT A-ARM BEARING AND SEAL KITS > \$13.95-\$78.95
 OEM replacement designed to rebuild the A-arm to factory specification. Contains bearings, pins, spacers and seals. Imported.

FITS MODEL	LOWER PART #	UPPER PART #
A-ARM BEARING KITS		
ARCTIC CAT		
250 2X4 99-05	0430-0313	0430-0313
250 4X4 01-05	0430-0313	0430-0313
300 2X4 98-04	0430-0313	0430-0313
300 4X4 98-05	0430-0313	0430-0313
375 2X4/4X4 W/AT 02	0430-0313	0430-0631
400 2X4 98-01	0430-0313	0430-0313
400 2X4 FIS W/AT 03	0430-0313	0430-0631
400 2X4 FIS W/AT 04	0430-0630	0430-0631
400 2X4 FIS W/MT 03	0430-0313	0430-0631
400 2X4 FIS W/MT 04	0430-0630	0430-0631
400 4X4 98-00	0430-0313	0430-0313
400 4X4 W/AT 03-04	0430-0313	0430-0631
400 4X4 W/MT 01	0430-0313	0430-0313
400 4X4 W/MT 02-04	0430-0313	0430-0631
400 DVX 04-08	0430-0048	0430-0040
400 FIS 4X4 TRV 09-13	0430-0630	0430-0631
400 FIS 4X4 W/AT 03	0430-0313	0430-0631
400 FIS 4X4 W/AT 04-08	0430-0630	0430-0631
400 FIS 4X4 W/MT 02-03	0430-0313	0430-0631
400 FIS 4X4 W/MT 04-08	0430-0630	0430-0631
400 TBX 4X4 04	0430-0313	0430-0631
400 TBX 4X4 05-06	0430-0630	0430-0631
400 TRV 07	0430-0630	0430-0631
400 VP 4X4 06	0430-0313	0430-0631
450 H1 10-11	0430-0630	0430-0631
450I EFI 12	0430-0630	0430-0631
450I TRV EFI 12	0430-0630	0430-0631
454 2X4 97-98	0430-0313	0430-0313
454 4X4 96-98	0430-0313	0430-0313
500 4X4 98-99	0430-0313	0430-0313
500 4X4 W/AT 00-01	0430-0313	0430-0313
500 4X4 W/AT 02	0430-0313	0430-0631
500 4X4 W/MT 00-01	0430-0313	0430-0313
500 FIS 4X4 W/AT 02-03	0430-0313	0430-0631
500 FIS 4X4 W/AT 04-09	0430-0630	0430-0631
500 FIS 4X4 W/MT 02	0430-0313	0430-0631
500 FIS 4X4 W/MT 04-09	0430-0630	0430-0631
500 FIS TBX 4X4 02-04	0430-0313	0430-0631
500 FIS TBX 4X4 05-06	0430-0630	0430-0631
500 FIS TRV 4X4 03-04	0430-0313	0430-0631
500 FIS TRV 4X4 05-06	0430-0630	0430-0631
500 FIS TRV 4X4 08	0430-0630	0430-0631
550 GT EFI 4X4 12-13	0430-0630	0430-0631
550 H1 FIS 4X4 09-11	0430-0630	0430-0631
550 I EFI 4X4 12-13	0430-0630	0430-0631
550 TRV 4X4 W/AT 09-11	0430-0630	0430-0631
550I TRV GT EFI 4X4 12-13	0430-0630	0430-0631
650 4X4 H1 05-09	0430-0630	0430-0631
650 4X4 H1, 650 4X4 H1 MUD PRO 10-11	0430-0630	0430-0631
650 4X4 W/AT V2 04-06	0430-0630	0430-0631
650I 4X4 12	0430-0630	0430-0631
700 DIESEL 08-13	0430-0630	0430-0631
700 EFI 4X4 07-12	0430-0630	0430-0631
700 EFI H1 MUDPRO 09-12	0430-0630	0430-0631
700 EFI H1 W/AT 08-11	0430-0630	0430-0631
700 GT EFI 12	0430-0630	0430-0631
700 H1 TRV 08-11	0430-0630	0430-0631
700I TRV GT EFI 12	0430-0630	0430-0631
1000I GT 12-13	0430-0630	0430-0631
H2 MUDPRO 10-11	0430-0630	0430-0631
H2 THUNDERCAT 08-11	0430-0630	0430-0631
550 PROWLER XT 09-13	0430-0630	0430-0631
650 PROWLER XT 06-09	0430-0630	0430-0631
700 PROWLER HDX 12	0430-0630	0430-0631
700 PROWLER XTX 08-12	0430-0630	0430-0631
1000 PROWLER XTX 11-13	0430-0630	0430-0631
PROWLER H2 1000 XTX 09-11	0430-0630	0430-0631

FITS MODEL	LOWER PART #	UPPER PART #
A-ARM BEARING KITS (CONT)		
CAN-AM		
OUTLANDER 400 03-13	0430-0665	-
OUTLANDER 500 07-13	0430-0665	-
OUTLANDER 330 04-05	0430-0665	-
OUTLANDER 500 PSTEERING 10-13	0430-0665	-
QUEST 500 02-03	0430-0665	0430-0665
RENEGADE 500 08-13	0430-0665	0430-0665
RENEGADE 500 PSTEERING 13	0430-0665	0430-0665
TRAXTER 500 01-05	0430-0665	0430-0665
OUTLANDER 650 07-13	0430-0665	0430-0665
OUTLANDER 650 PSTEERING 10-13	0430-0665	0430-0665
QUEST 650 02-04	0430-0665	0430-0665
TRAXTER 650 04-05	0430-0665	0430-0665
OUTLANDER 800 06-12	0430-0665	0430-0665
OUTLANDER 800 PSTEERING 10-13	0430-0665	0430-0665
OUTLANDER STD XT 800 12	0430-0665	0430-0665
RENEGADE 800 07-11	0430-0665	0430-0665
RENEGADE 800 PSTEERING 10-11	0430-0665	0430-0665
RENEGADE 800 XXC 12-13	0430-0665	0430-0665
OUTLANDER STD XT 1000 12	0430-0665	0430-0665
RENEGADE 1000 XXC 12-13	0430-0665	0430-0665
COMMANDER 800 11-13	0430-0665	-
COMMANDER 1000 11-13	0430-0665	-
HONDA		
TRX200 90-91	0430-0312	0430-0312
TRX200 96-97	0430-0312	0430-0312
TRX200D 90-97	0430-0312	0430-0312
TRX250 RECON 97-13	0430-0312	0430-0312
TRX300 FOURTRAX 300 88-92	0430-0312	-
TRX300 FOURTRAX 300 93-00	0430-0312	0430-0312
TRX300FW FOURTRAX 4X4 88-00	0430-0312	0430-0312
TRX350FE/FM/TE/TM 00-06	0430-0312	0430-0312
TRX400FA/F6A 04-07	0430-0312	0430-0312
TRX400FW FOURTRAX FOREMAN 4X4 95-03	0430-0312	0430-0312
TRX400X 12-13	0430-0044	0430-0044
TRX420FA 09-13	0430-0312	0430-0312
TRX420FE/FM 07-13	0430-0312	0430-0312
TRX420FPA 09-13	0430-0312	0430-0312
TRX420FPE/FPM 11-13	0430-0312	0430-0312
TRX420FPM 11-13	0430-0312	0430-0312
TRX420TE/TM 07-13	0430-0312	0430-0312
TRX450ES 98-01	0430-0312	0430-0312
TRX450FE/FM 02-04	0430-0312	0430-0312
TRX450S 98-01	0430-0312	0430-0312
TRX500FA 01-13	0430-0312	0430-0219
TRX500FE 05-13	0430-0312	0430-0219
TRX500FPA 04-09	0430-0312	0430-0219
TRX500FPE 05-13	0430-0312	0430-0219
TRX500FPM 08-13	0430-0312	0430-0219
TRX500FPM 08-13	0430-0312	0430-0219
TRX500TM 05-06	0430-0312	0430-0219
TRX650 RINCON 03-05	0430-0312	0430-0223
TRX680 RINCON 06-13	0430-0312	0430-0223
KAWASAKI		
KLF300B BAYOU 88-04	0430-0458	0430-0458
KLF300C BAYOU 4X4 89-04	0430-0458	0430-0458
KVF300A PRAIRIE 4X4 99-02	0430-0458	-
KVF300B PRAIRIE 2X4 99-02	0430-0458	-
KVF360A & C PRAIRIE 4X4 03-13	0430-0458	-
KVF360B PRAIRIE 03-10	0430-0458	-
KLF400 BAYOU 93-99	0430-0458	0430-0458
KVF400A PRAIRIE 4X4 97-98	0430-0458	-
KVF400C PRAIRIE 4X4 99-02	0430-0458	-
KVF400D PRAIRIE 99-02	0430-0458	-
KVF650 BRUTE FORCE 05-12	0430-0221	-
KVF650 I BRUTE FORCE 06-13	0430-0220	0430-0222
KVF650 PRAIRIE 02-03	0430-0221	-
KFX 700 V-FORCE 04-09	0430-0220	0430-0220
KVF700 PRAIRIE 04-06	0430-0221	-
KVF750 BRUTE FORCE 05-11	0430-0220	0430-0222
KVF750 BRUTE FORCE EPS 12-13	0430-0220	0430-0222
MULE 2500 94-95	0430-0458	-
MULE 2500 97-00	0430-0458	-
MULE 2510 4X4 93	0430-0458	-
MULE 2510 4X4 95	0430-0458	-

CONTINUED ON NEXT PAGE

FITS MODEL	LOWER PART #	UPPER PART#
A-ARM BEARING KITS (CON'T)		
KAWASAKI (CON'T)		
MULE 2510 4X4 97-00	0430-0458	-
MULE 2520 93	0430-0458	-
MULE 2520 95	0430-0458	-
MULE 2520 97-00	0430-0458	-
MULE 3000 01-08	0430-0458	-
MULE 3010 4X4 01-08	0430-0458	-
MULE 3020 01-03	0430-0458	-
MULE 4000 09-13	0430-0458	-
MULE 4010 4X4 09-12	0430-0458	-
MULE 2510 DIESEL 00-02	0430-0458	-
MULE 3010 DIESEL 03	0430-0458	-
MULE 3010 DIESEL 06	0430-0458	-
MULE 4010 4X4 DIESEL 10-12	0430-0458	-
POLARIS		
TRAIL BLAZER 250 90-99	0430-0627	-
TRAIL BLAZER 250 00-02	0430-0627	-
TRAIL BLAZER 250 03-06	0430-0628	-
TRAIL BOSS 250 94-99	0430-0627	-
TRAIL BOSS 250 4X4 87	0430-0628	-
TRAIL BOSS 250 4X4 88-92	0430-0628	-
TRAIL BOSS 250 4X4 93	0430-0627	-
XPLORER 250 4X4 00-02	0430-0627	-
300 2X4 94-95	0430-0627	-
300 4X4 94	0430-0627	-
HAWKEYE 2X4 06-11	0430-0628	-
HAWKEYE 4X4 06-07	0430-0628	-
SPORTSMAN 300 4X4 08-10	0430-0628	-
TRAIL BOSS 300 4X4 95	0430-0627	-
XPLORER 300 4X4 96-99	0430-0627	-
XPRESS 300 96-99	0430-0627	-
MAGNUM 325 2X4 00-02	0430-0627	-
MAGNUM 325 4X4 00-02	0430-0627	-
MAGNUM 325 4X4 HDS 01-02	0430-0627	-
TRAIL BOSS 325 00-02	0430-0627	-
XPEDITION 325 00-02	0430-0627	-
ATP 330 4X4 04-05	0430-0628	-
MAGNUM 330 2X4 03-05	0430-0628	-
MAGNUM 330 4X4 03-05	0430-0628	-
TRAIL BLAZER 330 08-13	0430-0628	-
TRAIL BOSS 330 03-13	0430-0628	-
SPORTSMAN 335 99-00	0430-0627	-
350L 2X4/4X4 93	0430-0627	-
SPORTSMAN 350 4X4 93	0430-0627	-
TRAIL BOSS 350L 2X4/4X4 90-92	0430-0628	-
400L 2X4 94-95	0430-0627	-
400L 4X4 94	0430-0627	-
SPORTSMAN 400 4X4 94-97	0430-0627	-
SPORTSMAN 400 4X4 01-02	0430-0627	-
SPORTSMAN 400 4X4 03	0430-0628	-
SPORTSMAN 400 4X4 05	0430-0628	-
SPORTSMAN 400 4X4 AA AE AG 04	0430-0628	-
SPORTSMAN 400 4X4 AQ AV 04	0430-0628	-
SPORTSMAN 400 HO 4X4 09-13	0430-0628	-
TRAIL BLAZER 400 03	0430-0628	-
XPLORER 400L 4X4 95-99	0430-0627	-
XPLORER 400L 4X4 00-02	0430-0627	-
XPRESS 400L 2X4 96-97	0430-0627	-
MAGNUM 425 2X4 95-98	0430-0627	-
MAGNUM 425 4X4 96	0430-0627	-
MAGNUM 425 4X4 98	0430-0627	-
XPEDITION 425 00-02	0430-0627	-
SPORTSMAN 450 06-07	0430-0628	-
ATP 500 4X4 04-05	0430-0628	-
MAGNUM 500 2X4 HDS 02	0430-0627	-
MAGNUM 500 4X4 99-02	0430-0627	-
MAGNUM 500 4X4 HDS 01	0430-0627	-
MAGNUM 500 4X4 HDS 02-03	0430-0628	-
SPORTSMAN 500 4X4 96-98	0430-0627	-
SPORTSMAN 500 4X4 00	0430-0627	-
SPORTSMAN 500 4X4 99	0430-0627	-
SPORTSMAN 500 4X4 HO 01-02	0430-0627	-
SPORTSMAN 500 4X4 HO 03	0430-0628	-
SPORTSMAN 500 4X4 HO 05-08	0430-0628	-
SPORTSMAN 500 4X4 HO AA-AC-AE-AG 04	0430-0628	-
SPORTSMAN 500 4X4 HO AD-AW 04	0430-0628	-

FITS MODEL	LOWER PART #	UPPER PART#
A-ARM BEARING KITS (CON'T)		
POLARIS (CON'T)		
SPORTSMAN 500 4X4 RSE 00-02	0430-0627	-
SPORTSMAN 500 EFI 09-10	0430-0628	-
SPORTSMAN 500 HO 08-13	0430-0628	-
SPORTSMAN 500 X2 06-09	0430-0666	-
SPORTSMAN 500 6X6 00-02	0430-0627	-
SPORTSMAN 500 6X6 03-08	0430-0628	-
SPORTSMAN TOURING 500 EFI 08	0430-0628	-
SPORTSMAN TOURING 500 EFI 09-13	0430-0666	-
XPLORER 500 97	0430-0627	-
SPORTSMAN 550 12	0430-0629	0430-0629
SPORTSMAN 550 EPS 10	0430-0666	0430-0666
SPORTSMAN 550 EPS 12-13	0430-0629	0430-0629
SPORTSMAN 550 X2 10	0430-0666	0430-0666
SPORTSMAN 550 X2 11-13	0430-0629	0430-0629
SPORTSMAN 550 EPS 11	0430-0629	0430-0629
SPORTSMAN TOURING EPS 550 11-13	0430-0629	0430-0629
SPORTSMAN XP 550 09	0430-0629	0430-0629
SPORTSMAN 600 4X4 03-05	0430-0628	-
SPORTSMAN 700 4X4 02-07	0430-0628	-
SPORTSMAN 700 TWIN 05-07	0430-0628	-
SPORTSMAN X2 700 TWIN EFI 08	0430-0666	-
SPORTSMAN 800 EFI 05-13	0430-0628	-
SPORTSMAN TOURING 800 EFI 08	0430-0628	-
SPORTSMAN TOURING 800 EFI 09	0430-0666	-
SPORTSMAN 800 EFI 6X6 09-12	0430-0628	-
SPORTSMAN X2 800 EFI 07-09	0430-0666	-
SPORTSMAN TOURING EPS 850 10	0430-0666	0430-0666
SPORTSMAN TOURING EPS 850 11-12	0430-0629	0430-0629
SPORTSMAN X2 850 11	0430-0629	0430-0629
SPORTSMAN XP 850 09	0430-0629	0430-0629
SPORTSMAN XP 850 10	0430-0666	0430-0666
SPORTSMAN XP 850 11-13	0430-0629	0430-0629
RANGER 4X4 400 10-12	0430-0632 ¹	-
RANGER 2X4 500 08-09	0430-0632 ¹	-
RANGER 4X4 500 04-08	0430-0632 ¹	-
RANGER 4X4 500 09-10	0430-0632 ¹	0430-0632 ¹
RANGER 4X4 500 11-13	0430-0632 ¹	-
RANGER 6X6 500 04	0430-0632 ¹	-
RANGER 4X4 700 05-06	0430-0632 ¹	-
RANGER 4X4 700 09	0430-0632 ¹	0430-0632 ¹
RANGER 4X4 700 CREW 09	0430-0632 ¹	-
RANGER 4X4 700 08	0430-0632 ¹	-
RANGER 6X6 700 EFI 06-09	0430-0632 ¹	-
RANGER 4X4 800 EFI 10-12	0430-0632 ¹	0430-0632 ¹
RANGER 4X4 800 EFI CREW 10-12	0430-0632 ¹	0430-0632 ¹
RANGER 6X6 800 2010 - 12	0430-0632 ¹	0430-0632 ¹
RANGER XP 800 12	0430-0632 ¹	0430-0632 ¹
RANGER 4X4 CREW DIESEL 900 11-13	0430-0632 ¹	0430-0632 ¹
RZR 570 EFI 12	0430-0628	0430-0628
RZR 4/EPS RGE 11	0430-0628	0430-0628
RZR S 800 09-13	0430-0628	0430-0628
RZR 800 08-09	0430-0628	0430-0628
RZR 800 11-13	0430-0628	0430-0628
RZR XP 900 11-13	0430-0666	0430-0628
SUZUKI		
LT-230E 87	0430-0046	0430-0046
LT-230E 88-93	0430-0041	0430-0041
LT-230S 85-87	0430-0046	0430-0046
LT-250S 89-90	0430-0042	0430-0042
LT-4WD 250 87-98	0430-0313	0430-0313
LT-F250 88-01	0430-0313	0430-0313
LT-F250 QZARK 02-12	0430-0313	0430-0313
LT-F4WD 250 97-98	0430-0313	0430-0313
LT-F300F KING QUAD 99-02	0430-0313	0430-0313
LT-F4WDX KING QUAD 300 91-98	0430-0313	0430-0313
LT-A400 2WD KING QUAD 08-09	0430-0313	0430-0313
LT-A400 EIGER 2WD 02-04	0430-0313	0430-0313
LT-A400 EIGER 2WD 07	0430-0313	0430-0313
LT-A400F 4WD KING QUAD 08-12	0430-0313	0430-0313
LT-A400F EIGER 4WD 02-07	0430-0313	0430-0313
LT-F400 2WD KING QUAD 08-09	0430-0313	0430-0313
LT-F400 EIGER 2WD 02-04	0430-0313	0430-0313
LT-F400 EIGER 2WD 07	0430-0313	0430-0313
LT-F400F 4WD KING QUAD 08-11	0430-0313	0430-0313

CONTINUED ON NEXT PAGE

PLOWS
WINCHES
UTV
RACKS
LUGGAGE
BODY
CONTROLS
ELECTRICAL
WHEELS & TIRES
SUSPENSION & DRIVE
ENGINE
NRA BY MOOSE
RIDER
TOWING
GARAGE
PROMO

FITS MODEL	LOWER PART #	UPPER PART #
A-ARM BEARING KITS (CON'T)		
SUZUKI (CON'T)		
LT-F400F EIGER 4WD 02-07	0430-0313	0430-0313
LTA-450 X KING QUAD 07-10	0430-0313	0430-0534
LT-A500F QUAD MASTER AUTO 00-01	0430-0313	0430-0313
LT-A500F VINSON 02-07	0430-0313	0430-0313
LT-A500X 09-12	0430-0313	0430-0667
LT-F500F QUAD MASTER 00-01	0430-0313	0430-0313
LT-F500F QUAD RUNNER 98-99	0430-0313	0430-0313
LT-F500F VINSON 02-07	0430-0313	0430-0313
LTA-700 X KING QUAD 05-07	0430-0313	0430-0534
LTV-700F TWIN PEAKS 04-06	0430-0221	-
LTA-750 X KING QUAD 08-12	0430-0313	0430-0667
YAMAHA		
YFA1 91-04	0430-0079	-
YFM125 GRIZZLY 04-13	0430-0079	-
YFB250 TIMBERWOLF 92-98	0430-0311	-
YFB250FW TIMBERWOLF 94-00	0430-0311	-
YFM250 RAPTOR 08-13	0430-0079	0430-0075
YFM250 BEARTRACKER 99-04	0430-0311	-
YFM250 BIG BEAR 07-09	0430-0311	-
YFM250 MOTO-4 89-91	0430-0072	-
YFM250B BRUIN 05-06	0430-0311	-
YFM350 GRIZZLY IRS 07-11	0430-0311	0430-0311
YFM350A BRUIN 2WD 04	0430-0311	0430-0311
YFM350BA BRUIN 2WD 05-06	0430-0311	0430-0311
YFM350FA BRUIN 4WD 04-06	0430-0311	0430-0311
YFM350FEW GRIZZLY 4WD 07-13	0430-0311	0430-0311
YFM350FW BIG BEAR 87-99	0430-0311	0430-0311
YFM350GW GRIZZLY 2WD 07-11	0430-0311	0430-0311
YFM350U BIG BEAR 96-99	0430-0311	0430-0311
YFM400 BIG BEAR 2WD 00-04	0430-0311	0430-0311
YFM400 BIG BEAR 4WD 00-06	0430-0311	0430-0311
YFM400 BIG BEAR IRS 07-13	0430-0311	0430-0311
YFM400 GRIZZLY IRS 07-08	0430-0311	0430-0311
YFM400 KODIAK 2WD 00-01	0430-0311	0430-0311
YFM400 KODIAK 2WD 03-04	0430-0311	0430-0311
YFM400 KODIAK 4WD 93-99	0430-0311	0430-0311
YFM400 KODIAK 4WD 00-06	0430-0311	0430-0311
YFM450 GRIZZLY IRS 07-12	0430-0311	0430-0311
YFM450 KODIAK 03-06	0430-0311	0430-0311
YFM550 GRIZZLY EPS 09-13	0430-0311	0430-0311
YFM600 GRIZZLY 98-01	0430-0311	-
YFM600 GRIZZLY 02	0430-0311	0430-0311
YFM660 GRIZZLY 02-08	0430-0311	0430-0311
YFM700 GRIZZLY 07-13	0430-0311	0430-0311
YFM700 GRIZZLY EPS 08-13	0430-0311	0430-0311
RHINO 450 06-09	0430-0311	0430-0311
RHINO 660 04-07	0430-0311	0430-0311
RHINO 700 FI 08-13	0430-0311	0430-0311

* BUSHINGS ONLY



UTV STEERING RACK TIE ROD ASSEMBLY KIT > \$14.95-\$88.95

Can save you hundreds of dollars versus the cost of a complete steering rack assembly. The inner rod assemblies have increased shaft diameters to improve strength. Each kit includes heavy-duty inner and outer rod ends with replacement boot, clamps and any required lock washers. Outer tie rod ends are also available individually. Imported.

*Tie Rod end kit, outer only – contains one tie rod end. This end attaches to the steering knuckle (2 required per vehicle).

*Tie Rod End Kit Left, Inner and outer – contains both tie rod end and shaft that connects to the steering rack as well as the outer tie rod end. Kit also contains a boot and required hardware for the left (driver) side.

*Tie Rod End Kit Right, Inner and outer – contains both tie rod end and shaft that connects to the steering rack as well as the outer tie rod end. Kit also contains a boot and required hardware for the right (passenger) side.

FITS MODEL	OUTER TIE ROD END (2 REQUIRED PER VEHICLE)	UTV RACK AND PINION END KIT LEFT HAND SIDE	UTV RACK AND PINION END KIT RIGHT HAND SIDE
UTV STEERING RACK TIE ROD ASSEMBLY KIT			
CAN-AM			
COMMANDER 800 11	0430-0669	0430-0698	0430-0699
COMMANDER 1000 11	0430-0669	0430-0698	0430-0699
KAWASAKI			
TERYX 750 4X4 08-12	0430-0684	0430-0696	0430-0697
POLARIS			
RANGER 4X4 400 10-12	0430-0455	0430-0686	0430-0687
RANGER 2X4 500 08-09	0430-0455	0430-0688	0430-0689
RANGER 4X4 500 05-12	0430-0455	0430-0688	0430-0689
RANGER 4X4 700 05-06	0430-0455	0430-0688	0430-0689
RANGER 4X4 700 08-09	0430-0455	0430-0688	0430-0689
RANGER 4X4 700 CREW 08-09	0430-0455	0430-0688	0430-0689
RANGER 6X6 700 EFI 06-09	0430-0455	0430-0688	0430-0689
RANGER 4X4 800 EFI 10-12	0430-0455	0430-0690	0430-0691
RANGER 4X4 800 EFI CREW 11-12	0430-0455	0430-0690	0430-0691
RANGER 6X6 800 10-12	0430-0455	0430-0690	0430-0691
RANGER XP 800 12	0430-0455	0430-0690	0430-0691
RANGER 4X4 CREW DIESEL 900 11	0430-0455	0430-0690	0430-0691
RZR S 800 09-12	0430-0455	0430-0692	0430-0693
RZR 800 08-12	0430-0455	0430-0694	0430-0695
RZR XP 900 11-12	0430-0455	0430-0702	0430-0703
YAMAHA			
RHINO 450 06-09	0430-0669	0430-0670	0430-0670
RHINO 660 04-07	0430-0669	0430-0670	0430-0670
RHINO 700 FI 08-12	0430-0669	0430-0670	0430-0670

TIE ROD ASSEMBLY

UPGRADE KITS > \$99.95-\$102.95

Heavy-duty 12mm style tie rod assemblies. Each kit contains two tie rods, four tie rod ends, cotter pins and jam nuts. Imported.



FITS MODEL	UPGRADE KIT PART #	REPL. TIE ROD ENDS PART #
TIE ROD ASSEMBLY UPGRADE KITS		
ARCTIC CAT		
250 2X4 99-05	0430-0566	0430-0066
250 2X4 06-09	0430-0314	0430-0227
250 4X4 01-05	0430-0566	0430-0066
300 2X4 98-04	0430-0566	0430-0066
300 2X4 10-11	0430-0315	0430-0227
300 4X4 98-05	0430-0566	0430-0066
366 FIS W/AT 08-11	0430-0566	0430-0066
375 2X4/4X4 W/AT 02	0430-0566	0430-0066
400 2X4 98-01	0430-0566	0430-0066
400 2X4 FIS W/AT 03-04	0430-0601	0430-0066
400 2X4 FIS W/MT 03-04	0430-0601	0430-0066
400 4X4 98-00	0430-0566	0430-0066
400 4X4 W/AT 03-04	0430-0566	0430-0066
400 4X4 W/MT 01-04	0430-0566	0430-0066
400 FIS 4X4 TRV 09-13	0430-0601	0430-0066
400 FIS 4X4 W/AT 03-08	0430-0601	0430-0066
400 FIS 4X4 W/MT 02-08	0430-0601	0430-0066

CONTINUED ON NEXT PAGE

FITS MODEL	UPGRADE KIT PART #	REPL. TIE ROD ENDS PART #
TIE ROD ASSEMBLY UPGRADE KITS (CON'T)		
ARCTIC CAT (CON'T)		
400 TBX 4X4 04-06	0430-0601	0430-0066
400 TRV 07	0430-0601	0430-0066
400 VP 4X4 06	0430-0566	0430-0066
450 HI 10-11	0430-0601	-
450I EFI 12	0430-0601	-
450I TRV EFI 12	0430-0601	-
454 2X4 97-98	0430-0566	0430-0066
454 4X4 96-98	0430-0566	0430-0066
500 4X4 98-99	0430-0566	0430-0066
500 4X4 W/AT 00-02	0430-0566	0430-0066
500 4X4 W/MT 00-01	0430-0566	0430-0066
500 FIS 4X4 W/AT 02-09	0430-0601	0430-0066
500 FIS 4X4 W/MT 02	0430-0601	0430-0066
500 FIS 4X4 W/MT 04-09	0430-0601	0430-0066
500 FIS TBX 4X4 02-06	0430-0601	0430-0066
500 FIS TRV 4X4 03-06	0430-0601	0430-0066
500 FIS TRV 4X4 08	0430-0601	0430-0066
550 GT EFI 4X4 12	0430-0601	0430-0066
550 HI FIS 4X4 09-11	0430-0601	0430-0066
550 I EFI 4X4 12	0430-0601	0430-0066
550 TRV 4X4 W/AT 09-11	0430-0601	0430-0066
550I TRV GT EFI 4X4 12	0430-0601	0430-0066
650 4X4 HI 05-09	0430-0601	0430-0066
650 4X4 HI, 650 4X4 HI MUD PRO 10-11	0430-0601	0430-0066
650 4X4 W/AT V2 04-06	0430-0601	0430-0066
650I 4X4 12	0430-0601	0430-0066
700 DIESEL 08-11	0430-0601	0430-0066
700 EFI 4X4 07-13	0430-0601	0430-0066
700 EFI HI MUDPRO 09-12	0430-0601	0430-0066
700 EFI HI W/AT 08-11	0430-0601	0430-0066
700 GT EFI 12	0430-0601	0430-0066
700 HI TRV 08-11	0430-0601	0430-0066
700I TRV GT EFI 12	0430-0601	0430-0066
1000I GT 12	0430-0601	0430-0066
H2 MUDPRO 10-11	0430-0601	0430-0066
H2 THUNDERCAT 08-11	0430-0601	0430-0066
CAN-AM		
OUTLANDER 330 04-05	0430-0673	0430-0059
OUTLANDER 400 03-13	0430-0673	0430-0059
OUTLANDER 500 07-13	0430-0673	0430-0059
OUTLANDER 500 PSTEERING 10-13	0430-0673	0430-0059
RENEGADE 500 08-13	0430-0673	0430-0059
OUTLANDER 650 07-13	0430-0673	0430-0059
OUTLANDER 650 PSTEERING 10-12	0430-0673	0430-0059
OUTLANDER 800 06-13	0430-0673	0430-0059
OUTLANDER 800 PSTEERING 10-12	0430-0673	0430-0059
OUTLANDER STD XT 800 12	0430-0674	0430-0059
RENEGADE 800 07-13	0430-0673	0430-0059
RENEGADE 800 PSTEERING 10-13	0430-0673	0430-0059
RENEGADE 800 XXC 12	0430-0674	0430-0059
OUTLANDER STD XT 1000 12-13	0430-0674	0430-0059
RENEGADE 1000 XXC 12-13	0430-0674	0430-0059
KAWASAKI		
KLF220 BAYOU 88-02	0430-0633	0430-0066
KLF250 BAYOU 03-11	0430-0633	0430-0066
KEF300 LAKOTA 95-03	-	0430-0066
KLF300C BAYOU 4X4 89-04	0430-0672	0430-0066
KLF400 BAYOU 93-99	0430-0672	0430-0066
KVF400A PRAIRIE 4X4 97-98	0430-0672	0430-0066
KVF400B PRAIRIE 98	0430-0672	0430-0066
KVF400C PRAIRIE 4X4 99-00	0430-0672	0430-0066
KVF400D PRAIRIE 99-00	0430-0672	0430-0066
KVF650 I BRUTE FORCE 06-13	0430-0600	0430-0066
KFX 700 V-FORCE 04-09	0430-0600	0430-0066
KVF750 BRUTE FORCE 05-13	0430-0600	0430-0066
KVF750 BRUTE FORCE EPS 12-13	0430-0600	0430-0066
SUZUKI		
LT-230E 87-93	0430-0672	0430-0066
LT-230S 85-88	0430-0672	0430-0066
LT-F230 86-87	0430-0672	0430-0066
LT-F250 88-01	-	0430-0066
LT-F250 OZARK 02-03	0430-0671	0430-0066
LT-F250 OZARK 04-12	-	0430-0227
LT-A400 2WD KING QUAD 08-09	0430-0566	0430-0066

FITS MODEL	UPGRADE KIT PART #	REPL. TIE ROD ENDS PART #
TIE ROD ASSEMBLY UPGRADE KITS (CON'T)		
SUZUKI (CON'T)		
LT-A400 EIGER 2WD 02-04	0430-0566	0430-0066
LT-A400 EIGER 2WD 07	-	0430-0227
LT-A400F 4WD KING QUAD 08-11	0430-0566	0430-0066
LT-A400F EIGER 4WD 02-04	0430-0566	0430-0066
LT-A400F EIGER 4WD 05-07	-	0430-0227
LT-F400 2WD KING QUAD 08-09	0430-0566	0430-0066
LT-F400 EIGER 2WD 02-04	0430-0566	0430-0066
LT-F400 EIGER 2WD 07	-	0430-0227
LT-F400F 4WD KING QUAD 08-11	0430-0566	0430-0066
LT-F400F EIGER 4WD 02-04	0430-0566	0430-0066
LT-F400F EIGER 4WD 05-07	-	0430-0227
LT-A500F VINSON 02-03	0430-0566	0430-0066
LT-A500F VINSON 04-07	0430-0317	0430-0227
LT-F500F VINSON 03	0430-0600	0430-0066
LT-F500F VINSON 04-07	0430-0317	0430-0227
YAMAHA		
YFB250FW TIMBERWOLF 94-00	0430-0321	0430-0227
YFM350FW BIG BEAR 87-97	0430-0321	0430-0227
YFM350FW BIG BEAR 98-99	0430-0315	0430-0227
YFM350U BIG BEAR 96-97	0430-0321	0430-0227
YFM350U BIG BEAR 98-99	0430-0315	0430-0227
YFM400 KODIAK 2WD 00-01	0430-0321	0430-0227
YFM400 KODIAK 4WD 93-99	0430-0321	0430-0227
YFM400 KODIAK 4WD 00-02	0430-0321	0430-0227
YFM550 GRIZZLY 09-13	0430-0320	0430-0227
YFM600 GRIZZLY 98-01	-	0430-0227
YFM600 GRIZZLY 02	0430-0320	0430-0227
YFM660 GRIZZLY 02-08	0430-0320	0430-0227
YFM700 GRIZZLY 07-13	0430-0320	0430-0227

TIE ROD ENDS > \$27.95-\$41.95

Contains inner and outer tie rod ends that are designed to replace loose and worn out tie rod ends. 2 required per vehicle. Imported.



FITS MODEL	PART #
TIE ROD ENDS	
ARCTIC CAT	
50 Y-6 YOUTH 04-05	0430-0053
90 Y-12 YOUTH 02-05	0430-0053
90 Y-12 YOUTH 06	0430-0307
250 2X4 99-05	0430-0453
250 2X4 06-09	0430-0065
250 4X4 01-05	0430-0453
300 2X4 98-04	0430-0453
300 2X4 10-11	0430-0065
300 4X4 98-05	0430-0453
366 FIS W/AT 08-11	0430-0453
375 2X4/4X4 W/AT 02	0430-0453
400 2X4 98-01	0430-0453
400 2X4 FIS W/AT 03-04	0430-0453
400 2X4 FIS W/MT 03-04	0430-0453
400 4X4 98-00	0430-0453
400 4X4 W/AT 03-04	0430-0453
400 4X4 W/MT 01-04	0430-0453
400 FIS 4X4 TRV 09-11	0430-0453
400 FIS 4X4 W/AT 03-08	0430-0453
400 FIS 4X4 W/MT 02-08	0430-0453
400 TBX 4X4 04-06	0430-0453
400 TRV 07	0430-0453
400 VP 4X4 06	0430-0453
450 HI 10-11	0430-0453
450I EFI 12	0430-0453
450I TRV EFI 12	0430-0453
454 2X4/4X4 97-98	0430-0453
500 4X4 98-99	0430-0453
500 4X4 W/AT 00-02	0430-0453
500 4X4 W/MT 00-01	0430-0453
500 FIS 4X4 W/AT 02-09	0430-0453
500 FIS 4X4 W/MT 02	0430-0453
500 FIS 4X4 W/MT 04-09	0430-0453
500 FIS TBX 4X4 02-06	0430-0453

CONTINUED ON NEXT PAGE

PLOWS
WINCHES
UTV
RACKS
LUGGAGE
BODY
CONTROLS
ELECTRICAL
WHEELS & TIRES
SUSPENSION & DRIVE
ENGINE
NRA BY MOOSE
RIDER
TOWING
GARAGE
PROMO



FITS MODEL	PART #
TIE ROD ENDS (CON'T)	
ARCTIC CAT (CON'T)	
500 FIS TRV 4X4 03-06	0430-0453
500 FIS TRV 4X4 08	0430-0453
550 GT EFI 4X4 12	0430-0453
550 HI FIS 4X4 09-11	0430-0453
550 I EFI 4X4 12	0430-0453
550 TRV 4X4 W/AT 09-11	0430-0453
550I TRV GT EFI 4X4 12	0430-0453
650 4X4 HI 05-09	0430-0453
650 4X4 HI, 650 4X4 HI MUD PRO 10-11	0430-0453
650 4X4 W/AT V2 04-06	0430-0453
650I 4X4 12	0430-0453
700 DIESEL 08-11	0430-0453
700 EFI 4X4 07-12	0430-0453
700 EFI HI MUDPRO 09-12	0430-0453
700 EFI HI W/AT 08-11	0430-0453
700 GT EFI 12	0430-0453
700 HI TRV 08-11	0430-0453
700I TRV GT EFI 12	0430-0453
1000I GT 12	0430-0453
H2 MUDPRO 10-11	0430-0453
H2 THUNDERCAT 08-11	0430-0453
CAN-AM	
OUTLANDER 330 04-05	0430-0059
OUTLANDER 400 03-12	0430-0059
OUTLANDER 500 07-12	0430-0059
OUTLANDER 500 PSTEERING 10-12	0430-0059
RENEGADE 500 08-12	0430-0059
OUTLANDER 650 07-12	0430-0059
OUTLANDER 650 PSTEERING 10-12	0430-0059
OUTLANDER 800 06-12	0430-0059
OUTLANDER 800 PSTEERING 10-12	0430-0059
OUTLANDER STD XT 800 12	0430-0059
RENEGADE 800 07-11	0430-0059
RENEGADE 800 PSTEERING 10-11	0430-0059
RENEGADE 800 XXC 12	0430-0059
OUTLANDER STD XT 1000 12	0430-0059
RENEGADE 1000 XXC 12	0430-0059
HONDA	
TRX70 86-87	0430-0051
TRX90 93-12	0430-0051
TRX125 85-88	0430-0051
TRX200 84	0430-0051
TRX200, TRX200D 90-91	0430-0058
TRX200, TRX200D 96-97	0430-0058
TRX200D 92-95	0430-0058
TRX200SX 86-88	0430-0051
TRX250 FOURTRAX 85-86	0430-0051
TRX250 FOURTRAX 87	0430-0055
TRX250 RECON 97-12	0430-0058
TRX300 FOURTRAX 88-00	0430-0058
TRX300FW FOURTRAX 4X4 88-00	0430-0058
TRX350D 88-89	0430-0053
TRX350FE 00-06	0430-0058
TRX350FM RANCHER 00-06	0430-0058
TRX350TE 00-06	0430-0058
TRX350TM RANCHER 00-06	0430-0058
TRX400FA 04-07	0430-0058
TRX400FGA RANCHER 4X4 04-07	0430-0058
TRX400FW FOREMAN 4X4 95-03	0430-0058
TRX400X 12	0430-0056
TRX420FA 09-12	0430-0058
TRX420FE/FM 07-12	0430-0058
TRX420FPA 09-12	0430-0058
TRX420FPE 11-12	0430-0058
TRX420FPM 11-12	0430-0058
TRX420TE/TM 07-10	0430-0058
TRX450ES 98-01	0430-0058
TRX450FE/FM 02-04	0430-0058
TRX450S 98-01	0430-0058
TRX500FA 01-12	0430-0058
TRX500FE 05-12	0430-0058
TRX500FGA 04-09	0430-0058
TRX500FM 05-12	0430-0058
TRX500FPA 09-12	0430-0058
TRX500FPE 08-12	0430-0058
TRX500FPM 08-12	0430-0058

FITS MODEL	PART #
TIE ROD ENDS (CON'T)	
HONDA (CON'T)	
TRX500TM 05-06	0430-0058
TRX650 RINCON 03-05	0430-0058
TRX680 RINCON 06-12	0430-0058
KAWASAKI	
KFX80 03-06	0430-0064
KLF110 87-88	0430-0062
KLF185 BAYOU 85-88	0430-0062
KLF220 BAYOU 88-02	0430-0062
KLF250 BAYOU 03-11	0430-0062
KEF300 LAKOTA 95-03	0430-0062
KLF300C BAYOU 4X4 89-04	0430-0062
KVF300 PRAIRIE 4X4/2X4 99-00	0430-0062
KVF300 PRAIRIE 4X4/2X4 01-02	0430-0063
KVF360A & C PRAIRIE 4X4 03-12	0430-0059
KVF360B PRAIRIE 03-10	0430-0059
KLF400 BAYOU 93-99	0430-0062
KVF400A PRAIRIE 4X4 97-00	0430-0062
KVF400C PRAIRIE 4X4 01-02	0430-0063
KVF650 BRUTE FORCE 05-11	0430-0224
KVF650 I BRUTE FORCE 06-12	0430-0056
KVF650 PRAIRIE 02-03	0430-0224
KFX 700 V-FORCE 04-09	0430-0225
KVF700 PRAIRIE 04-06	0430-0224
KVF750 BRUTE FORCE 05-12	0430-0056
POLARIS	
SPORTSMAN 90 01-06	0430-0307
SPORTSMAN 90 07-12	0430-0065
PHOENIX 200 06-09	0430-0062
SAWTOOTH 200 07	0430-0062
TRAIL BLAZER 250 90-95	0430-0069
TRAIL BLAZER 250 96	0430-0071
TRAIL BLAZER 250 97-06	0430-0070
TRAIL BOSS 250 88-99	0430-0069
TRAIL BOSS 250 4X4 87	0430-0069
TRAIL BOSS 250 4X4 89-93	0430-0071
XPLORER 250 4X4 00-02	0430-0070
300 2X4 94-95	0430-0069
300 4X4 94	0430-0071
HAWKEYE 2X4 06-11	0430-0668
HAWKEYE 4X4 06-07	0430-0668
SPORTSMAN 300 4X4 08-10	0430-0668
TRAIL BOSS 300 4X4 95	0430-0071
XPLORER 300 4X4 96-97	0430-0071
XPLORER 300 4X4 98-99	0430-0070
XPRESS 300 96-97	0430-0071
XPRESS 300 98-99	0430-0070
MAGNUM 325 2X4/4X4 00-02	0430-0070
TRAIL BOSS 325 00-02	0430-0070
XPEDITION 325 00-02	0430-0070
ATP 330 4X4 04-05	0430-0070
MAGNUM 330 2X4/4X4 03-05	0430-0070
TRAIL BOSS 330 03-12	0430-0070
SPORTSMAN 335 99-00	0430-0070
350L 2X4 93	0430-0069
350L 4X4 93	0430-0071
SPORTSMAN 350 4X4 93	0430-0071
TRAIL BOSS 350L 2X4 90-92	0430-0069
TRAIL BOSS 350L 4X4 90-92	0430-0071
SCRAMBLER 380 2X4 00	0430-0070
400L 2X4 94-95	0430-0069
400L 4X4 94	0430-0071
SPORTSMAN 400 4X4 94-97	0430-0071
SPORTSMAN 400 4X4 01-05	0430-0070
SPORTSMAN 400 HO 4X4 08-12	0430-0668
TRAIL BLAZER 400 03	0430-0070
XPLORER 400L 4X4 95-97	0430-0071
XPLORER 400L 4X4 98-02	0430-0070
XPRESS 400L 2X4 96-97	0430-0071
MAGNUM 425 2X4 95	0430-0069
MAGNUM 425 2X4 96-97	0430-0071
MAGNUM 425 2X4 98	0430-0070
MAGNUM 425 4X4 96	0430-0071
MAGNUM 425 4X4 98	0430-0070
XPEDITION 425 00-02	0430-0070
SPORTSMAN 450 06-07	0430-0070
DIESEL 455 4X4 99-01	0430-0070

CONTINUED ON NEXT PAGE

FITS MODEL	PART #
TIE ROD ENDS (CON'T)	
POLARIS (CON'T)	
MAGNUM 500 2X4 HDS 02	0430-0070
MAGNUM 500 4X4 99-02	0430-0070
MAGNUM 500 4X4 HDS 01-03	0430-0070
SPORTSMAN 500 4X4 96-97	0430-0071
SPORTSMAN 500 4X4 98-03	0430-0070
SPORTSMAN 500 4X4 HD 04-08	0430-0070
SPORTSMAN 500 EFI 09-10	0430-0070
SPORTSMAN 500 HD 08-12	0430-0070
SPORTSMAN 500 X2 06-09	0430-0070
SPORTSMAN TOURING 500 EFI 08-12	0430-0070
XPLORER 500 97	0430-0071
SPORTSMAN 550 12	0430-0063
SPORTSMAN 550 EPS 10	0430-0063
SPORTSMAN 550 EPS 12	0430-0063
SPORTSMAN 550 X2 10-12	0430-0063
SPORTSMAN 550 EPS 11	0430-0063
SPORTSMAN TOURING EPS 550 11-12	0430-0063
SPORTSMAN 600 4X4 03-05	0430-0070
SPORTSMAN 700 4X4 02-04	0430-0070
SPORTSMAN 700 TWIN EFI 05-07	0430-0070
SPORTSMAN X2 700 TWIN EFI 08	0430-0070
SPORTSMAN 800 EFI 05-12	0430-0070
SPORTSMAN TOURING 800 EFI 08-09	0430-0070
SPORTSMAN X2 800 EFI 07-09	0430-0070
SPORTSMAN TOURING EPS 850 10-12	0430-0063
SPORTSMAN X2 850 11	0430-0063
SPORTSMAN XP 850 EPS 10-12	0430-0063
BIG BOSS 250 4X6 89-92	0430-0069
BIG BOSS 250 6X6 91-93	0430-0071
BIG BOSS 300 6X6 94	0430-0071
BIG BOSS 350L 6X6 93	0430-0071
BIG BOSS 400L 6X6 94-97	0430-0071
MAGNUM 400L 6X6 96-97	0430-0071
BIG BOSS 500 6X6 98-99	0430-0070
BIG BOSS 500 6X6 00-03	0430-0070
SPORTSMAN 500 6X6 00-08	0430-0070
SPORTSMAN 800 EFI 6X6 09-12	0430-0070
RANGER 4X4 500 99	0430-0455 ¹
RANGER 4X4 500 04-10	0430-0455 ¹
RANGER 6X6 500 02	0430-0455 ¹
RANGER 6X6 500 04	0430-0455 ¹
RANGER 4X4 800 EFI CREW 10	0430-0455 ¹
RZR 570 EFI 12	0430-0455 ¹
SUZUKI	
LT-50 84-87	0430-0062
LT-80 87-06	0430-0064
LT-125 83-84	0430-0062
LT-125 85-87	0430-0064
LT-160 03-04	0430-0052
LT-160E 89-92	0430-0052
LT-F160 91-01	0430-0052
LT-185 84-87	0430-0064
LT-230E 87-93	0430-0064
LT-230GE 85-86	0430-0064
LT-230S 85-88	0430-0064
LT-F230 86-87	0430-0064
LT-250EF 85-86	0430-0064
LT-250R 85-86	0430-0064
LT-250S 89-90	0430-0064
LT-4WD 250 87-98	0430-0535
LT-F250 88-01	0430-0064
LT-F250 OZARK 02	0430-0064
LT-F250 OZARK 03	0430-0062
LT-F250 OZARK 04-12	0430-0065
LT-F250F (EXCEPT OZARK) 99-02	0430-0535
LT-F4WD 250 97-98	0430-0535
LT-300E 87-89	0430-0064
LT-F300F KING QUAD 99-02	0430-0535
LT-F4WDX KING QUAD 300 91-98	0430-0535
LT-A400 2WD KING QUAD 08-09	0430-0065
LT-A400 EIGER 2WD 02-04	0430-0064
LT-A400 EIGER 2WD 07	0430-0065
LT-A400F 4WD KING QUAD 08-11	0430-0065
LT-A400F EIGER 4WD 02-04	0430-0064
LT-A400F EIGER 4WD 05-07	0430-0065
LT-F400 2WD KING QUAD 08-09	0430-0065

FITS MODEL	PART #
TIE ROD ENDS (CON'T)	
SUZUKI (CON'T)	
LT-F400 EIGER 2WD 02-04	0430-0064
LT-F400 EIGER 2WD 07	0430-0065
LT-F400F 4WD KING QUAD 08-11	0430-0065
LT-F400F EIGER 4WD 02-04	0430-0064
LT-F400F EIGER 4WD 05-07	0430-0065
LTA-450 X KING QUAD 07-10	0430-0454
LT-A500F VINSON 02-03	0430-0062
LT-A500F VINSON 04-07	0430-0065
LT-A500X 09-10	0430-0227
LT-A500X 11	0430-0454
LT-F500F VINSON 03	0430-0062
LT-F500F VINSON 04-07	0430-0065
LTA-700 X KING QUAD 05-07	0430-0454
LTV-700F TWIN PEAKS 04-06	0430-0224
LTA-750 X KING QUAD 08-10	0430-0454
LTA-750 X KING QUAD 11	0430-0227
YAMAHA	
YFM80 85-88	0430-0061
YFM80 BADGER 92-01	0430-0061
YFM80 GRIZZLY 05-08	0430-0061
YFM100 87-91	0430-0061
YFA1 91-04	0430-0065
YFM125 GRIZZLY 04-12	0430-0065
YFM200 MOTO-4 86-89	0430-0065
YFM225 MOTO-4 86-88	0430-0065
YFB250 TIMBERWOLF 92-00	0430-0065
YFM250 BEARTRACKER 99-04	0430-0057
YFM250 BIG BEAR 07-09	0430-0057
YFM250 MOTO-4 89-91	0430-0065
YFM250B BRUIN 05-06	0430-0057
YFM350 GRIZZLY IRS 07-11	0430-0057
YFM350A BRUIN 2WD 04	0430-0057
YFM350BA BRUIN 2WD 05-06	0430-0057
YFM350ER MOTO-4 87-95	0430-0065
YFM350FA BRUIN 4WD 04-06	0430-0057
YFM350FGW GRIZZLY 4WD 07-12	0430-0057
YFM350FW BIG BEAR 87-97	0430-0065
YFM350FW BIG BEAR 98-99	0430-0065
YFM350GW GRIZZLY 2WD 07-11	0430-0057
YFM350U BIG BEAR 96-97	0430-0065
YFM350U BIG BEAR 98-99	0430-0065
YFM400 BIG BEAR 00-12	0430-0057
YFM400 GRIZZLY IRS 07-08	0430-0057
YFM400 KODIAK 2WD 00-01	0430-0065
YFM400 KODIAK 2WD 03-04	0430-0057
YFM400 KODIAK 4WD 93-02	0430-0065
YFM400 KODIAK 4WD 03-04	0430-0057
YFM400 KODIAK 4WD 05-06	0430-0615
YFM450 GRIZZLY IRS 07-12	0430-0615
YFM450 KODIAK 03-04	0430-0057
YFM450 KODIAK 05-06	0430-0615
YFM550 GRIZZLY 09-12	0430-0065
YFM600 GRIZZLY 98-01	0430-0065
YFM600 GRIZZLY 02	0430-0065
YFM660 GRIZZLY 02-08	0430-0065
YFM700 GRIZZLY 07-12	0430-0065 ¹

¹ KIT INCLUDES OUTER TIE ROD END ONLY



UPPER AND LOWER A-ARM UPGRADE KIT > \$126.95

OEM design incorporates small spherical bearings that carry the load of the entire front end. Kit contains acetal thermoplastic bushings and hardened ground pins for the entire front end of machine. Made in USA.

FITS MODEL	PART #
UPPER AND LOWER A-ARM UPGRADE KIT	
KAWASAKI	
KVF650 BRUTE FORCE 4X4 06-13	0430-0608
KVF750BRUTE FORCE 4X4 05-11	0430-0608

PLOWS
WINCHES
UTV
RACKS
LUGGAGE
BODY
CONTROLS
ELECTRICAL
WHEELS & TIRES
SUSPENSION & DRIVE
ENGINE
NRA BY MOOSE
RIDER
TOWING
GARAGE
PROMO



SWING ARM BEARING KITS > \$28.95-\$72.95

OEM replacement parts designed to rebuild the swing arm to factory specification. Kit contains bearings, seals, spacers and pins. Imported.

FITS MODEL	PART #
SWING ARM BEARING KITS	
ARCTIC CAT	
250 2X4 06-09	A28-1056
300 2X4 10-12	A28-1056
CAN-AM	
QUEST 500 02-03	1302-0235
TRAXTER 500 99-05	1302-0235
QUEST 650 02-04	1302-0235
TRAXTER 650 04-05	1302-0235
HONDA	
TRX90 93-13	A28-1009
TRX200 84	A28-1056
TRX200 90-91	A28-1010
TRX200 96-97	A28-1010
TRX200D 90-97	A28-1010
TRX200SX 86-88	A28-1010
ATC250ES 85-87	A28-1056
ATC250SX 85-87	A28-1056
TRX250 FOURTRAX 85-87	A28-1056
TRX250 RECON 97-13	A28-1056
TRX300 FOURTRAX 300 88-00	A28-1056
TRX350FE/FM/TE/TM 00-06	A28-1056
TRX400FA/FGA 04-07	A28-1056
TRX400FW FOREMAN 4X4 95-01	A28-1056
TRX400FW FOREMAN 4X4 02-03	A28-1056
TRX420 FE/FM 07-13	1302-0303
TRX420 FPE/FPM 11-13	1302-0303
TRX420 TE/TM 07-13	1302-0303
TRX450ES 98-01	A28-1056
TRX450FE/FM 02-04	A28-1056
TRX450S 98-01	A28-1056
TRX500FA RUBICON 01-06	A28-1056
TRX500FA RUBICON 07-13	A28-1056
TRX500FE FOREMAN 05-06	A28-1056
TRX500FE FOREMAN 07-11	A28-1056
TRX500FE FOREMAN 12	1302-0303
TRX500FGA RUBICON 04-06	A28-1056
TRX500FGA RUBICON 07-09	A28-1056
TRX500FM FOREMAN 05-06	A28-1056
TRX500FM FOREMAN 07-13	A28-1056
TRX500FM FOREMAN 12-13	1302-0303
TRX500FPA RUBICON 09-13	A28-1056
TRX500FPE/FPM FOREMAN 08-11	A28-1056
TRX500FPE/FPM FOREMAN 12-13	1302-0303
TRX500TM FOREMAN 05-06	A28-1056
KAWASAKI	
KEF300 LAKOTA 95-03	A28-1080
KVF300A PRAIRIE 4X4 99-02	A28-1059
KVF300B PRAIRIE 2X4 99-02	A28-1059
KVF360A & C PRAIRIE 4X4 03-13	A28-1059
KVF360B PRAIRIE 03-10	A28-1059
KVF400A PRAIRIE 4X4 97-98	A28-1059
KVF400B PRAIRIE 98	A28-1059
KVF400C PRAIRIE 4X4 99-02	A28-1059
KVF400D PRAIRIE 99-02	A28-1059
KVF650 BRUTE FORCE 05-12	A28-1059
KVF650 PRAIRIE 02-03	A28-1059
KFX 700 V-FORCE 04-09	A28-1059
KVF700 PRAIRIE 04-06	A28-1059
SUZUKI	
LT-230E 87-93	A28-1085
LT-230S 85-88	A28-1085
LT-250S 89-90	A28-1085
LT-300E 87-89	A28-1035
LT-A500F VINSON 02-07	1302-0235
LT-F500F VINSON 03-07	1302-0235
LTV-700F TWIN PEAKS 04-06	A28-1059
YAMAHA	
YFB250 TIMBERWOLF 92-98	A28-1058
YFB250FW TIMBERWOLF 94-00	A28-1058

FITS MODEL	PART #
SWING ARM BEARING KITS (CON'T)	
YAMAHA (CON'T)	
YFM250 BEARTRACKER 99-04	A28-1084
YFM250 BIG BEAR 07-09	A28-1084
YFM250 MOTO-4 89-91	A28-1058
YFM250B BRUIN 05-06	A28-1084
YFM350ER MOTO-4 87-95	A28-1058
YFM350FW BIG BEAR 87-99	A28-1058
YFM350U BIG BEAR 96-99	A28-1058
YFM350FX WOLVERINE 95-05	A28-1058
YFM400 BIG BEAR 2WD 00-04	A28-1084
YFM400 BIG BEAR 4WD 00-06	A28-1084
YFM400 KODIAK 4WD 93-99	A28-1058
YFM600 GRIZZLY 98-01	A28-1058

STEERING STEM BEARING AND SEAL KITS > \$6.95-\$40.95

Drop in replacement to upgrade OEM ball type bearing sets to taper bearings. Tapered roller bearings provide decreased maintenance, less wear, smooth operation and longer life. Comes complete with both upper and lower taper bearing cups, cones and seals. Imported.



FITS MODEL	PART #
STEERING STEM BEARING KITS	
CAN-AM	
RALLY 175 03-07	0410-0163 ¹
OUTLANDER 330 04-05	0410-0163 ¹
OUTLANDER 400 03-13	0410-0163 ¹
OUTLANDER 500 07-12	0410-0163 ¹
QUEST 500 02-03	0410-0163 ¹
RENEGADE 500 08-12	0410-0163 ¹
TRAXTER 500 99-05	0410-0163 ¹
OUTLANDER 650 07-12	0410-0163 ¹
QUEST 650 02-04	0410-0163 ¹
TRAXTER 650 04-05	0410-0163 ¹
OUTLANDER 800 06-12	0410-0163 ¹
RENEGADE 800 07-11	0410-0163 ¹
HONDA	
ATC70 73-85	0410-0021
ATC90 73-78	0410-0021
TRX90 93-12	0410-0070 ¹
ATC110 79-85	0410-0021
ATC125M 84-87	0410-0021
ATC185 80-83	0410-0021
ATC200E 82-83	0410-0021
ATC200ES 84	0410-0021
ATC200M 84-85	0410-0021
ATC200S 84-86	0410-0021
ATC200X 83-87	0410-0041
TRX200 90-91	0410-0070 ¹
TRX200 96-97	0410-0070 ¹
TRX200D 90-97	0410-0070 ¹
TRX250 RECON 97-13	0410-0070 ¹
TRX300 FOURTRAX 88-92	0410-0070 ¹
TRX300 FOURTRAX 93-00	0410-0069 ¹
TRX300FW FOURTRAX 4X4 88-00	0410-0069 ¹
ATC350X 85-86	0410-0041
TRX350FM/FE/TE/TM 00-06	0410-0069 ¹
TRX400FA/FGA 04-07	0410-0069 ¹
TRX400FW FOURTRAX FOREMAN 4X4 95-03	0410-0069 ¹
TRX420FA 09-13	0410-0069 ¹
TRX420FE/FM 07-13	0410-0069 ¹
TRX420FPE/FPM 11-13	0410-0069 ¹
TRX420TE/TM 07-10	0410-0069 ¹
TRX450ES 98-01	0410-0069 ¹
TRX450FE/FM 02-04	0410-0069 ¹
TRX450S 98-01	0410-0069 ¹
TRX500FA 01-13	0410-0072 ¹
TRX500FGA 04-09	0410-0072 ¹
TRX500FE/FM 05-11	0410-0072 ¹
TRX500FPA 09-13	0410-0072 ¹
TRX500TM 05-06	0410-0072 ¹
TRX650 RINCON 03-05	0410-0072 ¹
TRX680 RINCON 06-13	0410-0072 ¹

FITS MODEL	PART #
STEERING STEM BEARING KITS (CON'T)	
KAWASAKI	
KLF185 BAYOU 85-88	0410-0085 ¹
KLF220 BAYOU 88-02	0410-0085 ¹
KLF250 BAYOU 03-11	0410-0085 ¹
KXF250 TECATE 87-88	0410-0085 ¹
KXT250 TECATE 84-87	0410-0022
KEF300 LAKOTA 95-03	0410-0085
KLF300A BAYOU 86-87	0410-0085 ¹
KLF300B BAYOU 88-04	0410-0085 ¹
KLF300C BAYOU 4X4 89-04	0410-0085 ¹
KLF400 BAYOU 93-99	0410-0085 ¹
KVF400A PRAIRIE 4X4 97-99	0410-0085 ¹
KFX 700 V-FORCE 04-09	0410-0085 ¹
POLARIS	
TRAIL BLAZER 250 02-06	0410-0162 ¹
XPLORER 250 4X4 01-02	0410-0162 ¹
HAWKEYE 2X4 06-07	0410-0162 ¹
HAWKEYE 4X4 06-07	0410-0162 ¹
MAGNUM 325 2X4/4X4 02	0410-0162 ¹
MAGNUM 325 4X4 HDS 02	0410-0162 ¹
TRAIL BOSS 325 02	0410-0162 ¹
XPEDITION 325 02	0410-0162 ¹
ATP 330 4X4 04-05	0410-0162 ¹
MAGNUM 330 2X4 03-05	0410-0162 ¹
MAGNUM 330 4X4 03-05	0410-0162 ¹
TRAIL BOSS 330 03-07	0410-0162 ¹
SPORTSMAN 400 4X4 01-03	0410-0162 ¹
SPORTSMAN 400 4X4 05	0410-0162 ¹
SPORTSMAN 400 4X4 AA AE AG 04	0410-0162 ¹
TRAIL BLAZER 400 03	0410-0162 ¹
XPLORER 400L 4X4 01-02	0410-0162 ¹
XPEDITION 425 01-02	0410-0162 ¹
SPORTSMAN 450 06-07	0410-0162 ¹
ATP 500 4X4 04-05	0410-0162 ¹
MAGNUM 500 4X4 HDS 01-03	0410-0162 ¹
SPORTSMAN 500 4X4 HO 01-03	0410-0162 ¹
SPORTSMAN 500 4X4 HO 05-07	0410-0162 ¹
SPORTSMAN 500 4X4 HO 04	0410-0162 ¹
SPORTSMAN 500 X2 06-07	0410-0162 ¹
SPORTSMAN 500 6X6 01-07	0410-0162 ¹
SPORTSMAN 600 4X4 03-05	0410-0162 ¹
SPORTSMAN 700 4X4 02-07	0410-0162 ¹
SPORTSMAN 800 EFI 05-07	0410-0162 ¹
SPORTSMAN X2 800 EFI 07	0410-0162 ¹
YAMAHA	
YTM225 TRI-MOTO DXK 83-84	0410-0024
YFB250FW TIMBERWOLF 94-00	0410-0073 ¹
YFM350 GRIZZLY IRS 07-11	0410-0073 ¹
YFM350A BRUIN 2WD 04	0410-0073 ¹
YFM350BA BRUIN 2WD 05-06	0410-0073 ¹
YFM350FA BRUIN 4WD 04-06	0410-0073 ¹
YFM350FGW GRIZZLY 4WD 07-13	0410-0073 ¹
YFM350FW BIG BEAR 87-99	0410-0073 ¹
YFM350GW GRIZZLY 2WD 07-11	0410-0073 ¹
YFM350U BIG BEAR 96-99	0410-0073 ¹
YFM35FX WOLVERINE 95-99	0410-0073 ¹
YFM35FX WOLVERINE 00-05	0410-0073 ¹
YFM35X WOLVERINE 06-09	0410-0073 ¹
YFM400 BIG BEAR 2WD 00-04	0410-0073 ¹
YFM400 BIG BEAR 4WD 00-06	0410-0073 ¹
YFM400 BIG BEAR IRS 07-13	0410-0073 ¹
YFM400 GRIZZLY IRS 07-08	0410-0073 ¹
YFM400 KODIAK 2WD 00-01	0410-0073 ¹
YFM400 KODIAK 2WD 03-04	0410-0073 ¹
YFM400 KODIAK 4WD 93-99	0410-0073 ¹
YFM400 KODIAK 4WD 00-06	0410-0073 ¹
YFM450 GRIZZLY IRS 07-13	0410-0073 ¹
YFM450 KODIAK 03-06	0410-0073 ¹
YFM450FX WOLVERINE 4X4 06-10	0410-0073 ¹
YFM550 GRIZZLY 09-13	0410-0073 ¹
YFM600 GRIZZLY 98-02	0410-0073 ¹
YFM660 GRIZZLY 02-08	0410-0073 ¹
YFM700 GRIZZLY 07-13	0410-0073 ¹

¹ ACTUALLY A BALL BEARING



- PROMO
- GARAGE
- TOWING
- RIDER
- NRA BY MOOSE
- ENGINE
- SUSPENSION & DRIVE**
- WHEELS & TIRES
- ELECTRICAL
- CONTROLS
- BODY
- LUGGAGE
- RACKS
- UTV
- WINCHES
- PLOWS



HEAVY-DUTY U-JOINTS > \$23.95-\$33.95
 Heavy-duty construction.
 Imported. See chart on following pages.

U-JOINT FIGURE DIAGRAMS

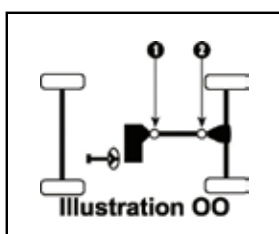
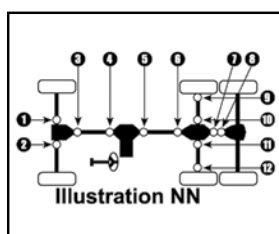
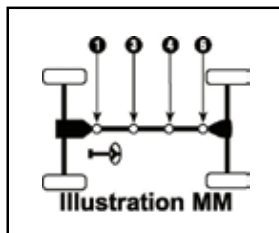
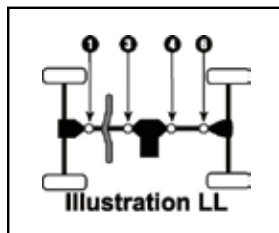
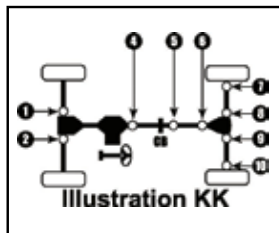
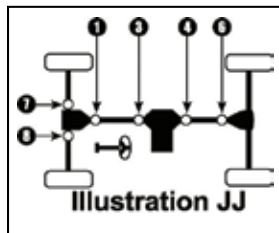
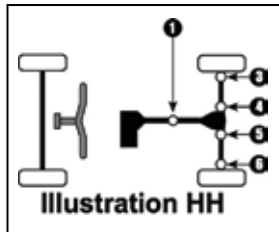
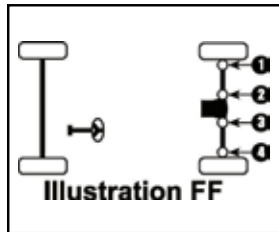
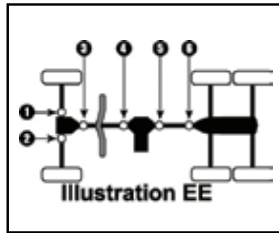
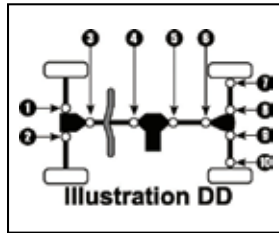
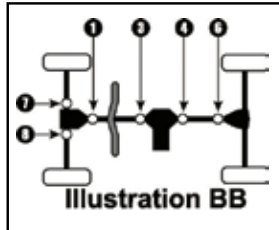
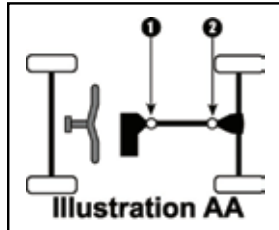

FITS MODEL	FIGURE	LOCATION	PART #
HEAVY-DUTY U-JOINTS			
ARCTIC CAT			
250 01-05 4X4	BB	1	1205-0129
300 98-05 4X4	BB	1	1205-0129
375 02 4X4	BB	1	1205-0179
400 07-08 4X4	BB	1	1205-0179
400 05-06 4X4-EXC. VALUE PACKAGE	BB	1	1205-0179
400 05-06 4X4-VALUE PACKAGE	BB	1,3	1205-0179
400 03-04 4X4	BB	1	1205-0179
400 98-02 4X4	BB	1	1205-0129
454 96-98 4X4	BB	1	1205-0129
500 03-08 4X4	BB	1	1205-0179
500 98-02 4X4	BB	1	1205-0129
650 07-08 4X4-SECONDARY DRIVE SHAFT	BB	4	1205-0179
650 05-06 4X4 H1-SECONDARY DRIVE SHAFT	BB	4	1205-0179
650 05-06 4X4 V2-REAR DRIVE SHAFT	BB	4,6	1205-0197
650 05-06 4X4 V2-FRONT DRIVE SHAFT	BB	1,3	1205-0179
650 04 4X4-REAR DRIVE SHAFT	BB	4,6	1205-0197
650 04 4X4-FRONT DRIVE SHAFT	BB	1,3	1205-0179
700 07-08 4X4-FRONT DRIVE SHAFT	BB	1,3	1205-0179
650 PROWLER XT 07-08 4X4-REAR DRIVE SHAFT	MM	6	1205-0197
650 PROWLER XT 07-08 4X4-SECONDARY DRIVE SHAFT	MM	4	1205-0197
650 PROWLER XT 06 4X4-SECONDARY DRIVE SHAFT	MM	3	1205-0179
650 PROWLER XT 06 4X4-SECONDARY DRIVE SHAFT	MM	4	1205-0197
650 PROWLER XT 06 4X4-REAR DRIVE SHAFT	MM	6	1205-0197
650 PROWLER XT 06 4X4-FRONT DRIVE SHAFT	MM	1	1205-0179
CAN-AM			
OUTLANDER 330 04-05 4WD	LL	4,6	1205-0194
OUTLANDER 330 04-05 2WD	AA	1,2	1205-0194
OUTLANDER 400 06-07 4WD	LL	4,6	1205-0194
OUTLANDER 400 03-05 2WD	AA	1,2	1205-0194
OUTLANDER 400 03-05 4WD	LL	4,6	1205-0194
OUTLANDER 500 07 4WD	LL	3	1205-0194
OUTLANDER 500 07 4WD	LL	4,6	1205-0195
QUEST 500 04 4WD	LL	4	1205-0194
QUEST 500 02-03 4WD	LL	1,3,4	1205-0194
RENEGADE 500 08 4WD	LL	3	1205-0194
RENEGADE 500 08 4WD	LL	4,6	1205-0195
TRAXTER 99-04 4WD	LL	1,3,4	1205-0194
OUTLANDER 650 06-07 4WD	LL	3	1205-0194
OUTLANDER 650 06-07 4WD	LL	4,6	1205-0195
QUEST 650 04 4WD	LL	4	1205-0195
QUEST 650 02-03 4WD	LL	1,3	1205-0194
QUEST 650 02-03 4WD	LL	4	1205-0195
OUTLANDER 800 06-07 4WD	LL	3	1205-0194
OUTLANDER 800 06-07 4WD	LL	4,6	1205-0195
RENEGADE 800 07-08 4WD	LL	3	1205-0194
RENEGADE 800 07-08 4WD	LL	4,6	1205-0195
JOHN DEERE			
GATOR HPX 05-07 4X4-FRONT AXLES	JJ	7,8	1205-0004
KAWASAKI			
BAYOU 300 89-04 4WD-FRONT PROP SHAFT	LL	1,3	1205-0005
PRAIRIE 300 99-02 2WD	AA	2	1205-0153
PRAIRIE 300 99-02 4WD-REAR PROP SHAFT	LL	4	1205-0153
PRAIRIE 300 99-02 4WD-FRONT PROP SHAFT	LL	1,3	1205-0175
PRAIRIE 360 10-13 4WD	LL	4	1205-0180
PRAIRIE 360 03-09 2WD	AA	2	1205-0180
PRAIRIE 360 03-09 4WD	LL	4	1205-0180
BAYOU 400 93-99 4WD-FRONT PROP SHAFT	LL	1,3	1205-0175
PRAIRIE 400 98-02 2WD	AA	2	1205-0153
PRAIRIE 400 98-02 4WD-FRONT PROP SHAFT	LL	1,3	1205-0175
PRAIRIE 400 98-02 4WD-REAR PROP SHAFT	LL	4	1205-0153
PRAIRIE 400 97 4WD-FRONT PROP SHAFT	LL	1,3	1205-0175
PRAIRIE 400 97 4WD-REAR PROP SHAFT	LL	4	1205-0153
BRUTE FORCE 650 05-13 4WD	LL	4	1205-0180
BRUTE FORCE 650 06-13 4WD	DD	5,6	1205-0180
PRAIRIE 650 02-03 4WD	LL	4	1205-0180
KFX 700 04-09 2WD	AA	2	1205-0180
PRAIRIE 700 04-06 4WD	LL	4	1205-0180
BRUTE FORCE 750 05-11 4WD	DD	5,6	1205-0180
TERYX 750 08-12 4WD-REAR PROP SHAFT	LL	4,6	1205-0130
TERYX 750 08-12 4WD-FRONT PROP SHAFT	LL	1,3	1205-0153
MULE 1000 88 2WD-450CC	KK	7,10	1205-0153
MULE 2500 94-00 2WD-620CC	KK	7,8,9,10	1205-0130
MULE 2510 00-02 4WD-620CC & 950CC DIESEL-REAR AXLES	KK	7,8,9,10	1205-0130
MULE 2510 00-02 4WD-620CC & 950CC DIESEL-PROP SHAFT	KK	4,5,6	1205-0153
MULE 2510 93-99 4WD-620CC-FRONT AXLES	KK	1,2	1205-0130
MULE 2510 93-99 4WD-620CC-PROP SHAFT	KK	4,5,6	1205-0005

CONTINUED ON NEXT PAGE

FITS MODEL	FIGURE	LOCATION	PART #
HEAVY-DUTY U-JOINTS (CON'T)			
KAWASAKI (CON'T)			
MULE 2510 93-99 4WD-620CC-REAR AXLES	KK	7,8,9,10	1205-0130
MULE 2520 93-00 2WD-620CC	FF	1,2,3,4	1205-0130
MULE 3000 01-08 2WD-620CC	FF	1,2,3,4	1205-0130
MULE 3010 01-08 4WD-620CC & 950CC DIESEL-PROP SHAFT	KK	4,5,6	1205-0153
MULE 3010 01-08 4WD-620CC & 950CC DIESEL-REAR AXLES	KK	7,8,9,10	1205-0130
MULE 3020 01-03 2WD-620CC	FF	1,2,3,4	1205-0130
MULE 4000 09-12 2WD-620CC	FF	1,2,3,4	1205-0130
MULE 4010 09-12 4WD-620CC & 950CC DIESEL-PROP SHAFT	KK	4,5,6	1205-0153
MULE 4010 09-12 4WD-620CC & 950CC DIESEL-REAR AXLES	KK	7,8,9,10	1205-0130
MULE 610 05-12 4WD-400CC-FRONT PROP SHAFT	DD	3,4	1205-0153
MULE 610 05-12 4WD-400CC-REAR PROP SHAFT	DD	5,6	1205-0153
KUBOTA			
RTV900 03-08 4WD-REAR AXLES	DD	7,8,9,10	1205-0198
POLARIS			
250 93 4X4	BB	7,8	1205-0004
250 93 6X6	EE	1,2	1205-0004
250 90 4X4	BB	7,8	1205-0004
BIG BOSS 250 91-92 6X6	EE	1,2	1205-0004
TRAIL BOSS 250 87-92 4X4	BB	7,8	1205-0004
XPLORER 250 00-02 4X4-PROP SHAFT	BB	1,3	1205-0004
XPLORER 250 00-02 4X4-FRONT AXLES	BB	7,8	1205-0004
300 96 4X4	BB	7,8	1205-0004
300 95 4X4	BB	7,8	1205-0010
300 94 6X6	EE	1,2	1205-0004
300 94 4X4	BB	7,8	1205-0004
SPORTSMAN 300 08-10 4X4-FRONT PROP SHAFT	JJ	1,3	1205-0004
MAGNUM 325 01-02 2X4-REAR PROP SHAFT	AA	1	1205-0004
MAGNUM 325 01-02 4X4-FRONT AXLES-EXC.			
HDS (VISCO-LOK)	BB	7,8	1205-0010
MAGNUM 325 01-02 4X4-REAR PROP SHAFT	BB	4	1205-0004
MAGNUM 325 01-02 4X4-FRONT PROP SHAFT-EXC.			
HDS (VISCO-LOK)	BB	1,3	1205-0004
MAGNUM 325 00 4X4-FRONT AXLES	BB	7,8	1205-0010
MAGNUM 325 00 4X4-FRONT PROP SHAFT	BB	1,3	1205-0004
MAGNUM 325 00 4X4-REAR PROP SHAFT	BB	4	1205-0004
MAGNUM 325 00 2X4-REAR PROP SHAFT	AA	1	1205-0004
XPEDITION 325 00-02 4X4-REAR PROP SHAFT	DD	5	1205-0004
XPEDITION 325 00-02 4X4-FRONT AXLES	DD	1,2	1205-0010
XPEDITION 325 00-02 4X4-FRONT PROP SHAFT	DD	3,4	1205-0004
XPLORER 300 96-99 4X4	BB	7,8	1205-0010
ATP 330 05 4X4-REAR PROP SHAFT	BB	4	1205-0010
ATP 330 05 4X4-FRONT PROP SHAFT	BB	1,3	1205-0004
ATP 330 04 4X4-FRONT AXLES	BB	7,8	1205-0004
ATP 330 04 4X4-FRONT PROP SHAFT	BB	1,3	1205-0004
ATP 330 04 4X4-REAR PROP SHAFT	BB	4	1205-0010
MAGNUM 330 06 4X4-REAR PROP SHAFT	BB	4	1205-0010
MAGNUM 330 06 4X4-FRONT PROP SHAFT	BB	1,3	1205-0004
MAGNUM 330 05 2X4-REAR PROP SHAFT	AA	1	1205-0010
MAGNUM 330 05 4X4-REAR PROP SHAFT	BB	4	1205-0010
MAGNUM 330 05 4X4-FRONT PROP SHAFT	BB	1,3	1205-0004
MAGNUM 330 03-04 4X4-FRONT AXLES-EXC.			
HDS (VISCO-LOK)	BB	7,8	1205-0004
MAGNUM 330 03-04 4X4-FRONT PROP SHAFT	BB	1,3	1205-0004
MAGNUM 330 03-04 2X4-REAR PROP SHAFT	AA	1	1205-0010
MAGNUM 330 03-04 4X4-REAR PROP SHAFT	BB	4	1205-0010
SPORTSMAN 335 99-00 4X4-FRONT AXLES	DD	1,2	1205-0010
SPORTSMAN 335 99-00 4X4-PROP SHAFT	DD	3,4	1205-0004
SPORTSMAN 335 99-00 4X4-REAR AXLES	DD	7,10	1205-0007
SPORTSMAN 335 99-00 4X4-REAR AXLES	DD	8,9	1205-0009
350L 93 4X4	BB	7,8	1205-0004
350L 93 6X6	EE	1,2	1205-0004
350L 90 4X4	BB	7,8	1205-0004
TRAIL BOSS 350L 90-92 4X4	BB	7,8	1205-0004
400 95 6X6-W/ OUTSIDE LOCK RINGS	EE	1,2	1205-0010
400 95 6X6-W/ INSIDE LOCK RINGS	EE	1,2	1205-0004
400 94 4X4	BB	7,8	1205-0004
400 94 6X6	EE	1,2	1205-0004
BIG BOSS 400L 97 6X6	EE	1,2	1205-0010
SCRAMBLER 400 98-02 4X4-FRONT AXLE-W/ INSIDE LOCK RINGS	BB	7,8	1205-0004
SCRAMBLER 400 98-02 4X4-FRONT AXLE-W/ OUTSIDE LOCK RINGS	BB	7,8	1205-0010
SCRAMBLER 400 98-02 4X4-PROP SHAFT	BB	1,3	1205-0004
SCRAMBLER 400 95-97 4X4-W/ INSIDE LOCK RINGS	BB	7,8	1205-0004
SCRAMBLER 400 95-97 4X4-W/ OUTSIDE LOCK RINGS	BB	7,8	1205-0010
SPORTSMAN 400 08-10 4X4-PROP SHAFT	BB	1,3	1205-0004

FITS MODEL	FIGURE	LOCATION	PART #
HEAVY-DUTY U-JOINTS (CON'T)			
POLARIS (CON'T)			
SPORTSMAN 400 05 4X4-PROP SHAFT	BB	1,3	1205-0004
SPORTSMAN 400 02-04 4X4-FRONT AXLES	BB	7,8	1205-0004
SPORTSMAN 400 02-04 4X4-PROP SHAFT	BB	1,3	1205-0004
SPORTSMAN 400 01 4X4-FRONT AXLES	BB	7,8	1205-0010
SPORTSMAN 400 01 4X4-PROP SHAFT	BB	1,3	1205-0004
SPORTSMAN 400 97 4X4	BB	7,8	1205-0010
SPORTSMAN 400 95-96 4X4-W/ INSIDE LOCK RINGS	BB	7,8	1205-0004
SPORTSMAN 400 95-96 4X4-W/ OUTSIDE LOCK RINGS	BB	7,8	1205-0010
SPORTSMAN 400 93-94 4X4	BB	7,8	1205-0004
XPLORER 400 99-02 4X4-PROP SHAFT	BB	1,3	1205-0004
XPLORER 400 99-02 4X4-FRONT AXLES	BB	7,8	1205-0004
XPLORER 400 97-98 4X4	BB	7,8	1205-0010
XPLORER 400 95-96 4X4-W/ INSIDE LOCK RINGS	BB	7,8	1205-0004
XPLORER 400 95-96 4X4-W/ OUTSIDE LOCK RINGS	BB	7,8	1205-0010
MAGNUM 425 98 4X4	BB	7,8	1205-0010
MAGNUM 425 97 6X6	EE	1,2	1205-0010
MAGNUM 425 97 4X4	BB	7,8	1205-0010
MAGNUM 425 96 6X6-W/ OUTSIDE LOCK RINGS	EE	1,2	1205-0010
MAGNUM 425 96 6X6-W/ INSIDE LOCK RINGS	EE	1,2	1205-0004
MAGNUM 425 96 4X4-W/ INSIDE LOCK RINGS	BB	7,8	1205-0004
MAGNUM 425 96 4X4-W/ OUTSIDE LOCK RINGS	BB	7,8	1205-0010
MAGNUM 425 95 4X4-W/ INSIDE LOCK RINGS	BB	7,8	1205-0004
MAGNUM 425 95 4X4-W/ OUTSIDE LOCK RINGS	BB	7,8	1205-0010
XPEDITION 425 02 4X4-FRONT AXLES	DD	1,2	1205-0004
XPEDITION 425 02 4X4-FRONT PROP SHAFT	DD	3,4	1205-0004
XPEDITION 425 02 4X4-REAR PROP SHAFT	DD	5	1205-0004
XPEDITION 425 00-01 4X4-FRONT AXLES	DD	1,2	1205-0010
XPEDITION 425 00-01 4X4-FRONT PROP SHAFT	DD	3,4	1205-0004
XPEDITION 425 00-01 4X4-REAR PROP SHAFT	DD	5	1205-0004
SPORTSMAN 450 06-07 4X4	BB	1,3	1205-0004
DIESEL 455 01 4X4-FRONT AXLES-W/ INSIDE LOCK RINGS	DD	1,2	1205-0004
DIESEL 455 01 4X4-FRONT AXLES-W/ OUTSIDE LOCK RINGS	DD	1,2	1205-0010
DIESEL 455 01 4X4-PROP SHAFT-FROM 12/07/00	DD	3,4	1205-0004
DIESEL 455 00 4X4-FRONT AXLES	DD	1,2	1205-0010
DIESEL 455 99 4X4-FRONT AXLES	DD	1,2	1205-0010
DIESEL 455 99 4X4-PROP SHAFT	DD	3,4	1205-0004
DIESEL 455 99 4X4-REAR AXLES	DD	7,10	1205-0007
DIESEL 455 99 4X4-REAR AXLES	DD	8,9	1205-0009
ATV 500 H.O. 05 4X4-REAR PROP SHAFT	BB	4	1205-0010
ATV 500 H.O. 05 4X4-FRONT PROP SHAFT	BB	1,3	1205-0004
ATV 500 H.O. 04 4X4-REAR PROP SHAFT	BB	4	1205-0010
ATV 500 H.O. 04 4X4-FRONT PROP SHAFT	BB	1,3	1205-0004
ATV 500 H.O. 04 4X4-FRONT AXLES	BB	7,8	1205-0004
ATV PRO 500 02 4X4-FRONT PROP SHAFT	BB	1,3	1205-0004
ATV PRO 500 02 4X4-REAR PROP SHAFT	BB	4	1205-0004
BIG BOSS 500 98-99 6X6	EE	1,2	1205-0010
MAGNUM 500 03 4X4-FRONT PROP SHAFT	BB	1,3	1205-0004
MAGNUM 500 03 4X4-REAR PROP SHAFT	BB	4	1205-0010
MAGNUM 500 02 4X4-FRONT AXLES-EXC. HDS (VISCO-LOK)	BB	7,8	1205-0010
MAGNUM 500 02 4X4-FRONT PROP SHAFT	BB	1,3	1205-0004
MAGNUM 500 02 4X4-REAR PROP SHAFT	BB	4	1205-0004
MAGNUM 500 01 4X4-FRONT AXLES-EXC. HDS (VISCO-LOK)	BB	7,8	1205-0010
MAGNUM 500 01 4X4-FRONT PROP SHAFT-EXC.			
HDS (VISCO-LOK)	BB	1,3	1205-0004
MAGNUM 500 01 4X4-REAR PROP SHAFT	BB	4	1205-0004
MAGNUM 500 99-00 4X4-FRONT AXLES	BB	7,8	1205-0010
MAGNUM 500 99-00 4X4-FRONT PROP SHAFT	BB	1,3	1205-0004
SCRAMBLER 500 10 4X4-PROP SHAFT	BB	1,3	1205-0004
SCRAMBLER 500 99-09 4X4-PROP SHAFT	BB	1,3	1205-0004
SCRAMBLER 500 99-09 4X4-FRONT AXLES	BB	7,8	1205-0004
SCRAMBLER 500 98 4X4-FRONT AXLES	BB	7,8	1205-0010
SCRAMBLER 500 98 4X4-PROP SHAFT	BB	1,3	1205-0004
SCRAMBLER 500 97 4X4	BB	7,8	1205-0010
SPORTSMAN 500 09-10 4X4-PROP SHAFT	BB	1,3	1205-0004
SPORTSMAN 500 05-08 6X6-FRONT AXLES	EE	1,2	1205-0004
SPORTSMAN 500 05-08 6X6-PROP SHAFT	EE	3,4	1205-0004
SPORTSMAN 500 05-08 4X4-PROP SHAFT	BB	1,3	1205-0004
SPORTSMAN 500 04 6X6-FRONT AXLES	EE	1,2	1205-0004
SPORTSMAN 500 04 6X6-PROP SHAFT	EE	3,4	1205-0004
SPORTSMAN 500 04 4X4-FRONT AXLES	BB	7,8	1205-0004
SPORTSMAN 500 04 4X4-PROP SHAFT-W/ INSIDE LOCK RINGS	BB	1,3	1205-0004
SPORTSMAN 500 04 4X4-PROP SHAFT-W/ OUTSIDE LOCK RINGS	BB	1,3	1205-0010
SPORTSMAN 500 02-03 4X4-FRONT AXLES	BB	7,8	1205-0004
SPORTSMAN 500 02-03 4X4-PROP SHAFT	BB	1,3	1205-0004

PLOWS
WINCHES
UTV
RACKS
LUGGAGE
BODY
CONTROLS
ELECTRICAL
WHEELS & TIRES
SUSPENSION & DRIVE
ENGINE
NRA BY MODEL
RIDER
TOWING
GARAGE
PROMO

FITS MODEL	FIGURE	LOCATION	PART #
HEAVY-DUTY U-JOINTS (CON'T)			
POLARIS (CON'T)			
SPORTSMAN 500 02-03 6X6-FRONT AXLES	EE	1,2	1205-0004
SPORTSMAN 500 02-03 6X6-PROP SHAFT	EE	3,4	1205-0004
SPORTSMAN 500 99-01 4X4-FRONT AXLES	BB	7,8	1205-0010
SPORTSMAN 500 99-01 4X4-PROP SHAFT-W/ OUTSIDE LOCK RINGS	BB	1,3	1205-0010
SPORTSMAN 500 99-01 6X6-FRONT AXLES	EE	1,2	1205-0010
SPORTSMAN 500 99-01 6X6-PROP SHAFT	EE	3,4	1205-0004
SPORTSMAN 500 99-01 4X4-PROP SHAFT-W/ INSIDE LOCK RINGS	BB	1,3	1205-0004
SPORTSMAN 500 98 4X4-FRONT AXLES	DD	1,2	1205-0010
SPORTSMAN 500 98 4X4-PROP SHAFT	DD	3,4	1205-0004
SPORTSMAN 500 98 4X4-REAR AXLES	DD	7,10	1205-0007
SPORTSMAN 500 98 4X4-REAR AXLES	DD	8,9	1205-0009
SPORTSMAN 500 97 4X4-FRONT AXLES	DD	1,2	1205-0004
SPORTSMAN 500 97 4X4-PROP SHAFT	DD	3,4	1205-0004
SPORTSMAN 500 97 4X4-REAR AXLES	DD	7,10	1205-0007
SPORTSMAN 500 97 4X4-REAR AXLES	DD	8,9	1205-0009
SPORTSMAN 500 96 4X4-FRONT AXLES-W/ OUTSIDE SNAP RINGS	DD	1,2	1205-0010
SPORTSMAN 500 96 4X4-PROP SHAFT	DD	3,4	1205-0004
SPORTSMAN 500 96 4X4-REAR AXLES	DD	7,10	1205-0007
SPORTSMAN 500 96 4X4-REAR AXLES	DD	8,9	1205-0009
SPORTSMAN 500 96 4X4-FRONT AXLES-W/ INSIDE SNAP RINGS	DD	1,2	1205-0004
SPORTSMAN X2 500 06-09 4X4-PROP SHAFT	BB	1,3	1205-0004
XPLORER 500 97 4X4-FRONT AXLES	DD	1,2	1205-0004
XPLORER 500 97 4X4-PROP SHAFT	DD	3,4	1205-0004
XPLORER 500 97 4X4-REAR AXLES	DD	7,10	1205-0007
XPLORER 500 97 4X4-REAR AXLES	DD	8,9	1205-0009
SPORTSMAN X2 550 10 4X4-FRONT PROP SHAFT	BB	1,3	1205-0004
SPORTSMAN X2 550 10 4X4-REAR PROP SHAFT	BB	4,6	1205-0004
SPORTSMAN XP 550 09-10 4X4-FRONT PROP SHAFT	BB	1,3	1205-0004
SPORTSMAN XP 550 09-10 4X4-REAR PROP SHAFT	BB	4,6	1205-0004
SPORTSMAN 600 05 4X4-FRONT PROP SHAFT	BB	1,3	1205-0004
SPORTSMAN 600 05 4X4-REAR PROP SHAFT	BB	4,6	1205-0004
SPORTSMAN 600 03-04 4X4-FRONT AXLES	BB	7,8	1205-0004
SPORTSMAN 600 03-04 4X4-REAR PROP SHAFT	BB	4,6	1205-0004
SPORTSMAN 600 03-04 4X4-FRONT PROP SHAFT	BB	1,3	1205-0004
SPORTSMAN 700 05-07 4X4-FRONT PROP SHAFT	BB	1,3	1205-0004
SPORTSMAN 700 05-07 4X4-REAR PROP SHAFT	BB	4,6	1205-0004
SPORTSMAN 700 02-04 4X4-FRONT AXLES	BB	7,8	1205-0004
SPORTSMAN 700 02-04 4X4-FRONT PROP SHAFT	BB	1,3	1205-0004
SPORTSMAN 700 02-04 4X4-REAR PROP SHAFT	BB	4,6	1205-0004
SPORTSMAN 800 09-10 4X4-FRONT PROP SHAFT	BB	1,3	1205-0004
SPORTSMAN 800 09-10 4X4-REAR PROP SHAFT	BB	4,6	1205-0004
SPORTSMAN 800 09-10 6X6-FRONT PROP SHAFT	BB	1,3	1205-0004
SPORTSMAN 800 09-10 6X6-REAR PROP SHAFT	BB	4,6	1205-0004
SPORTSMAN 800 05-08 4X4-FRONT PROP SHAFT	BB	1,3	1205-0004
SPORTSMAN 800 05-08 4X4-REAR PROP SHAFT	BB	4,6	1205-0004
SPORTSMAN X2 800 07-09 4X4-PROP SHAFT	BB	1,3	1205-0004
SPORTSMAN 850 10 4X4-FRONT PROP SHAFT	LL	1,3	1205-0004
SPORTSMAN 850 10 4X4-REAR PROP SHAFT	LL	4,6	1205-0004
SPORTSMAN XP 850 09-10 4X4-FRONT PROP SHAFT	BB	1,3	1205-0004
SPORTSMAN XP 850 09-10 4X4-REAR PROP SHAFT	BB	4,6	1205-0004
RANGER 400 10-13 4X4-FRONT PROP SHAFT	JJ	1,3	1205-0004
RANGER 03-04 2X4-SERIES 11	OO	1,2	1205-0004
RANGER 03-04 4X4-SERIES 11-FRONT AXLES	JJ	7,8	1205-0004
RANGER 03-04 4X4-SERIES 11-FRONT PROP SHAFT	JJ	1,3	1205-0004
RANGER 03-04 4X4-SERIES 11-REAR PROP SHAFT	JJ	4,6	1205-0004
RANGER 03-04 6X6-SERIES 11-COUPLER SHAFT	NN	7,8	1205-0004
RANGER 03-04 6X6-SERIES 11-FRONT AXLES	NN	1,2	1205-0004
RANGER 03-04 6X6-SERIES 11-FRONT PROP SHAFT	NN	3,4	1205-0004
RANGER 03-04 6X6-SERIES 11-MIDDLE AXLES	NN	9,10,11,12	1205-0007
RANGER 03-04 6X6-SERIES 11-REAR PROP SHAFT	NN	6	1205-0004
RANGER 02 2X4-SERIES 10	OO	1,2	1205-0004
RANGER 02 4X4-SERIES 10-FRONT AXLES	JJ	7,8	1205-0004
RANGER 02 4X4-SERIES 10-FRONT PROP SHAFT	JJ	1,3	1205-0004
RANGER 02 4X4-SERIES 10-REAR PROP SHAFT	JJ	4,6	1205-0004
RANGER 02 6X6-SERIES 10-FRONT AXLES	NN	1,2	1205-0004
RANGER 02 6X6-SERIES 10-FRONT PROP SHAFT	NN	3,4	1205-0004
RANGER 02 6X6-SERIES 10-MIDDLE AXLES	NN	9,10,11,12	1205-0007
RANGER 02 6X6-SERIES 10-COUPLER SHAFT	NN	7,8	1205-0004
RANGER 02 6X6-SERIES 10-REAR PROP SHAFT	NN	6	1205-0004
RANGER 99-01 6X6-FRONT AXLES	NN	1,2	1205-0004
RANGER 99-01 6X6-FRONT PROP SHAFT	NN	3,4	1205-0004
RANGER 99-01 6X6-REAR PROP SHAFT	NN	6	1205-0004

FITS MODEL	FIGURE	LOCATION	PART #
HEAVY-DUTY U-JOINTS (CON'T)			
POLARIS (CON'T)			
RANGER 99-01 6X6-MIDDLE AXLES	NN	9,10,11,12	1205-0007
RANGER 500 10 4X4-FRONT PROP SHAFT	JJ	1,3	1205-0004
RANGER 500 08-09 4X4-REAR PROP SHAFT	JJ	4,6	1205-0004
RANGER 500 08-09 4X4-FRONT PROP SHAFT	JJ	1,3	1205-0004
RANGER 500 08-09 2X4	OO	1,2	1205-0004
RANGER 500 06-07 2X4	OO	1,2	1205-0004
RANGER 500 06-07 4X4-FRONT PROP SHAFT	JJ	1,3	1205-0004
RANGER 500 06-07 4X4-REAR PROP SHAFT	JJ	4,6	1205-0004
RANGER 500 05 2X4	OO	1,2	1205-0004
RANGER 500 05 4X4-FRONT PROP SHAFT	JJ	1,3	1205-0004
RANGER 500 05 4X4-REAR PROP SHAFT	JJ	4,6	1205-0004
RANGER 500 05 6X6-COUPLER SHAFT	NN	7,8	1205-0004
RANGER 500 05 6X6-FRONT AXLES	NN	1,2	1205-0004
RANGER 500 05 6X6-FRONT PROP SHAFT	NN	3,4	1205-0004
RANGER 500 05 6X6-MIDDLE AXLES	NN	9,10,11,12	1205-0007
RANGER 500 05 6X6-REAR PROP SHAFT	NN	5,6	1205-0004
RANGER 500 11-13 4X4-CREW FRONT PROP SHAFT	PP	1,2,3	1205-0004
RANGER 500 11-13 4X4-EXC. CREW FRONT PROP SHAFT	JJ	1,3	1205-0004
RZR 570 12-13 4X4-FRONT PROP SHAFT	JJ	1,3	1205-0004
RANGER 700 08-09 6X6-COUPLER SHAFT	NN	7,8	1205-0004
RANGER 700 08-09 6X6-FRONT PROP SHAFT	NN	3,4	1205-0004
RANGER 700 08-09 6X6-REAR PROP SHAFT	NN	5,6	1205-0004
RANGER 700 08-09 4X4-REAR PROP SHAFT	JJ	4,6	1205-0004
RANGER 700 08-09 4X4-FRONT PROP SHAFT	JJ	1,3	1205-0004
RANGER 700 06-07 6X6-COUPLER SHAFT	NN	7,8	1205-0004
RANGER 700 06-07 6X6-FRONT PROP SHAFT	NN	3,4	1205-0004
RANGER 700 06-07 6X6-REAR PROP SHAFT	NN	5,6	1205-0004
RZR 800 11-13 4X4 4 SEATER-FRONT PROP SHAFT	PP	1,2,3	1205-0004
RZR 800 11-13 4X4 EXC. 4 SEATER-FRONT PROP SHAFT	JJ	1,3	1205-0004
RANGER 800 10-13 4X4-EFI CREW PROP SHAFT	PP	1,2,3	1205-0004
RANGER 800 10-13 4X4-EXC. EFI CREW FRONT SHAFT	JJ	1,3	1205-0004
RANGER 800 10 4X4-EFI CREW PROP SHAFT	JJ	1,3	1205-0004
RANGER 800 10-13 6X6-COUPLER SHAFT	NN	7,8	1205-0004
RANGER 800 10-13 6X6-FRONT PROP SHAFT	NN	3,4	1205-0004
RANGER 800 10-13 6X6-REAR PROP SHAFT	NN	5,6	1205-0004
RANGER 800 10 4X4-EXC. EFI CREW FRONT SHAFT	KK	4,5,6	1205-0004
RANGER 900 13 4X4 DIESEL-FRONT PROP SHAFT	PP	1,2,3	1205-0004
RANGER 900 13 4X4 DIESEL-REAR PROP SHAFT	PP	4,6	1205-0004
RANGER 900 13 4X4 DIESEL CREW-FRONT PROP SHAFT	PP	1,2,3	1205-0004
RANGER 900 13 4X4 DIESEL CREW-REAR PROP SHAFT	PP	4,6	1205-0004
RANGER 900 13 4X4-XP-FRONT PROP SHAFT	JJ	1,3	1205-0004
RANGER EV 10 4X4-FRONT PROP SHAFT	JJ	1,3	1205-0004
RANGER MVRS 09 2X4	OO	1,2	1205-0004
RANGER MVRS 08 4X4-FRONT PROP SHAFT	JJ	1,3	1205-0004
RANGER MVRS 08 4X4-REAR PROP SHAFT	JJ	4,6	1205-0004
RZR 08-10 4X4-FRONT PROP SHAFT	JJ	1,3	1205-0004
RZR S "SPORT" 10 4X4-FRONT PROP SHAFT	JJ	1,3	1205-0004
RANGER TM 04-06 2X4	OO	1,2	1205-0004
RANGER XP 700 05-09 4X4-FRONT PROP SHAFT	JJ	1,3	1205-0004
RANGER XP 700 05-09 4X4-REAR PROP SHAFT	JJ	4,6	1205-0004
SUZUKI			
OZARK 250 02-06 2WD	HH	1	1205-0174
QUAD RUNNER 250 02 4WD-REAR AXLES	HH	3,6	1205-0172
QUAD RUNNER 250 02 4WD-REAR AXLES	HH	4,5	1205-0178
QUAD RUNNER 250 02 4WD-SECONDARY DRIVE	HH	1	1205-0174
QUAD RUNNER 250 01 2WD	HH	3,6	1205-0172
QUAD RUNNER 250 01 2WD	HH	4,5	1205-0178
QUAD RUNNER 250 01 4WD-REAR AXLES	HH	3,6	1205-0172
QUAD RUNNER 250 01 4WD-REAR AXLES	HH	4,5	1205-0178
QUAD RUNNER 250 01 4WD-SECONDARY DRIVE	HH	1	1205-0174
QUAD RUNNER 250 95-00 2WD	HH	3,6	1205-0172
QUAD RUNNER 250 95-00 4WD-REAR AXLES	HH	3,6	1205-0172
QUAD RUNNER 250 95-00 4WD-SECONDARY DRIVE	HH	1	1205-0176
QUAD RUNNER 250 94 2WD	HH	3,6	1205-0172
QUAD RUNNER 250 94 2WD	HH	4,5	1205-0169
QUAD RUNNER 250 94 4WD-REAR AXLES	HH	3,6	1205-0172
QUAD RUNNER 250 94 4WD-SECONDARY DRIVE	HH	1	1205-0176
QUAD RUNNER 250 88-93 2WD	HH	3,6	1205-0172
QUAD RUNNER 250 88-93 2WD	HH	4,5	1205-0169
QUAD RUNNER 250 88-93 4WD-REAR AXLES	HH	3,6	1205-0172
QUAD RUNNER 250 88-93 4WD-REAR AXLES	HH	4,5	1205-0169
QUAD RUNNER 250 88-93 4WD-SECONDARY DRIVE	HH	1	1205-0176
QUAD RUNNER 250 87 4WD-REAR AXLES	HH	3,6	1205-0008
QUAD RUNNER 250 87 4WD-REAR AXLES	HH	4,5	1205-0169
QUAD RUNNER 250 87 4WD-SECONDARY DRIVE	HH	1	1205-0176
QUAD SPORT 250 04-06 2WD	HH	1	1205-0174

CONTINUED ON NEXT PAGE

FITS MODEL	FIGURE	LOCATION	PART #
HEAVY-DUTY U-JOINTS (CON'T)			
SUZUKI (CON'T)			
KING QUAD 300 01-02 4WD-REAR AXLES	HH	3,6	1205-0173
KING QUAD 300 01-02 4WD-REAR AXLES	HH	4,5	1205-0178
KING QUAD 300 01-02 4WD-SECONDARY DRIVE	HH	1	1205-0174
KING QUAD 300 96-00 4WD-REAR AXLES	HH	3,6	1205-0173
KING QUAD 300 96-00 4WD-SECONDARY DRIVE	HH	1	1205-0176
KING QUAD 300 91-93 4WD-REAR AXLES	HH	3,6	1205-0173
KING QUAD 300 91-93 4WD-REAR AXLES	HH	4,5	1205-0169
QUAD RUNNER 300 95 4WD-REAR AXLES	HH	3,6	1205-0173
QUAD RUNNER 300 95 4WD-SECONDARY DRIVE	HH	1	1205-0174
QUAD RUNNER 300 94 4WD-REAR AXLES	HH	3,6	1205-0173
QUAD RUNNER 300 94 4WD-REAR AXLES	HH	4,5	1205-0169
QUAD RUNNER 300 94 4WD-SECONDARY DRIVE	HH	1	1205-0176
EIGER 400 05-06 4WD-FRONT BEVEL GEAR	LL	1	1205-0174
EIGER 400 05-06 4WD-SECONDARY DRIVE	LL	4,6	1205-0174
EIGER 400 02-04 2WD	HH	1	1205-0174
EIGER 400 02-04 4WD-FRONT BEVEL GEAR	LL	1	1205-0174
EIGER 400 02-04 4WD-SECONDARY DRIVE	LL	4,6	1205-0174
KING QUAD 500 09-11 4WD - FRONT BEVEL GEAR	LL	3	1205-0177
KING QUAD 500 09-11 4WD - SECONDARY DRIVE	LL	6	1205-0176
KING QUAD 400 10-12 4WD-FRONT BEVEL GEAR	LL	3	1205-0174
KING QUAD 400 10-12 4WD-SECONDARY DRIVE	LL	4,6	1205-0174
QUAD MASTER 500 01 4WD-FRONT BEVEL GEAR	LL	1	1205-0174
QUAD MASTER 500 01 4WD-SECONDARY DRIVE	LL	4,6	1205-0176
QUAD MASTER 500 00 4WD-FRONT BEVEL GEAR	LL	1	1205-0176
QUAD MASTER 500 00 4WD-SECONDARY DRIVE	LL	4	1205-0176
QUAD RUNNER 500 02 4WD-FRONT BEVEL GEAR	LL	1	1205-0174
QUAD RUNNER 500 02 4WD-SECONDARY DRIVE	LL	4,6	1205-0174
QUAD RUNNER 500 01 4WD	LL	4,6	1205-0174
QUAD RUNNER 500 98-00 4WD	LL	4	1205-0176
VINSON 500 02-06 4WD-FRONT BEVEL GEAR	LL	1	1205-0174
VINSON 500 02-06 4WD-SECONDARY DRIVE	LL	4	1205-0174
VINSON 500 02-06 4WD-SECONDARY DRIVE	LL	6	1205-0176
KING QUAD 700 05-06 4WD-FRONT BEVEL GEAR	LL	3	1205-0177
KING QUAD 700 05-06 4WD-SECONDARY DRIVE	LL	6	1205-0176
KING QUAD 750 08-12 4WD-FRONT BEVEL GEAR	LL	3	1205-0177
KING QUAD 750 08-12 4WD-SECONDARY DRIVE	LL	6	1205-0176
TWIN PEAKS 700 04-05 4WD	LL	4	1205-0180
QUV UTILITY 620 05 4WD-FRONT PROP SHAFT	KK	4	1205-0153
QUV UTILITY 620 05 4WD-REAR AXLES	KK	7,8,9,10	1205-0130
QUV UTILITY 620 05 4WD-REAR PROP SHAFT	KK	5,6	1205-0153

YAMAHA			
MOTO-4 225 86-88 2WD	AA	1	1205-0170
MOTO-4 250 89-91 2WD	AA	1	1205-0170
TIMBERWOLF 250 99-00 4WD-FRONT DRIVE SHAFT	LL	1,3	1205-0003
TIMBERWOLF 250 99-00 4WD-REAR DRIVE SHAFT	LL	4	1205-0170
TIMBERWOLF 250 94-98 4WD-FRONT DRIVE SHAFT	LL	1,3	1205-0003
TIMBERWOLF 250 94-98 4WD-REAR DRIVE SHAFT	LL	4	1205-0170
TIMBERWOLF 250 94-98 2WD	AA	1	1205-0170
TIMBERWOLF 250 92-93 2WD	AA	1	1205-0170
BEAR TRACKER 250 99-04 2WD	AA	1	1205-0170
BIG BEAR 250 07-08 2WD	HH	1	1205-0170
BRUIN 250 06 2WD	HH	1	1205-0170
BIG BEAR 350 87-99 4WD-FRONT DRIVE SHAFT	LL	1,3	1205-0003
BIG BEAR 350 87-99 4WD-REAR DRIVE SHAFT	LL	4,6	1205-0006
BIG BEAR 350 86 4WD-FRONT DRIVE SHAFT	LL	1,3	1205-0170
GRIZZLY 350 07-08 4WD-W/O IRS	LL	4	1205-0170
GRIZZLY 350 07-08 2WD	HH	1	1205-0170
GRIZZLY 350 07-08 4WD-W/ IRS-(FRONT DRIVE SHAFT)	LL	1,3	1205-0170
GRIZZLY 350 07-08 4WD-W/ IRS-(REAR DRIVE SHAFT)	LL	4,6	1205-0170
WOLVERINE 350 06-08 2WD	HH	1	1205-0170
WOLVERINE 350 95-98 4WD-FRONT DRIVE SHAFT	LL	1,3	1205-0170
WOLVERINE 350 95-98 4WD-REAR DRIVE SHAFT	LL	4,6	1205-0006
BIG BEAR 400 07-08 4WD-W/ IRS-(FRONT DRIVE SHAFT)	LL	1,3	1205-0170
BIG BEAR 400 07-08 4WD-W/ IRS-(REAR DRIVE SHAFT)	LL	4,6	1205-0170
BIG BEAR 400 06 4WD-FRONT DRIVE SHAFT	LL	1,3	1205-0170
GRIZZLY 400 07-08 4WD-REAR DRIVE SHAFT	LL	4,6	1205-0170
KODIAK 400 05-06 4WD-REAR DRIVE SHAFT	AA	1,2	1205-0170
KODIAK 400 98-99 4WD-FRONT DRIVE SHAFT	LL	1,3	1205-0170
KODIAK 400 93-97 4WD-FRONT DRIVE SHAFT	LL	1,3	1205-0003
KODIAK 400 93-97 4WD-REAR DRIVE SHAFT	LL	4,6	1205-0006
GRIZZLY 450 07-08 4WD-W/ IRS-(FRONT DRIVE SHAFT)	LL	1,3	1205-0170
GRIZZLY 450 07-08 4WD-W/ IRS-(REAR DRIVE SHAFT)	LL	4,6	1205-0170
KODIAK 450 03-06 4WD-REAR DRIVE SHAFT	LL	4,6	1205-0170
KODIAK 450 03-06 4WD-FRONT DRIVE SHAFT	LL	1,3	1205-0170
WOLVERINE 450 07-08 4WD-REAR DRIVE SHAFT	HH	1	1205-0170
GRIZZLY 600 98 4WD-FRONT DRIVE SHAFT	LL	1,3	1205-0003

FITS MODEL	FIGURE	LOCATION	PART #
HEAVY-DUTY U-JOINTS (CON'T)			
YAMAHA (CON'T)			
GRIZZLY 600 98 4WD-REAR DRIVE SHAFT	LL	4,6	1205-0006
RHINO 450 06 4WD-FRONT DRIVE SHAFT	LL	1,3	1205-0170
RHINO 660 04-07 4WD-FRONT DRIVE SHAFT	LL	1,3	1205-0170
RHINO 700 08-09 4WD-FRONT DRIVE SHAFT	LL	1,3	1205-0170

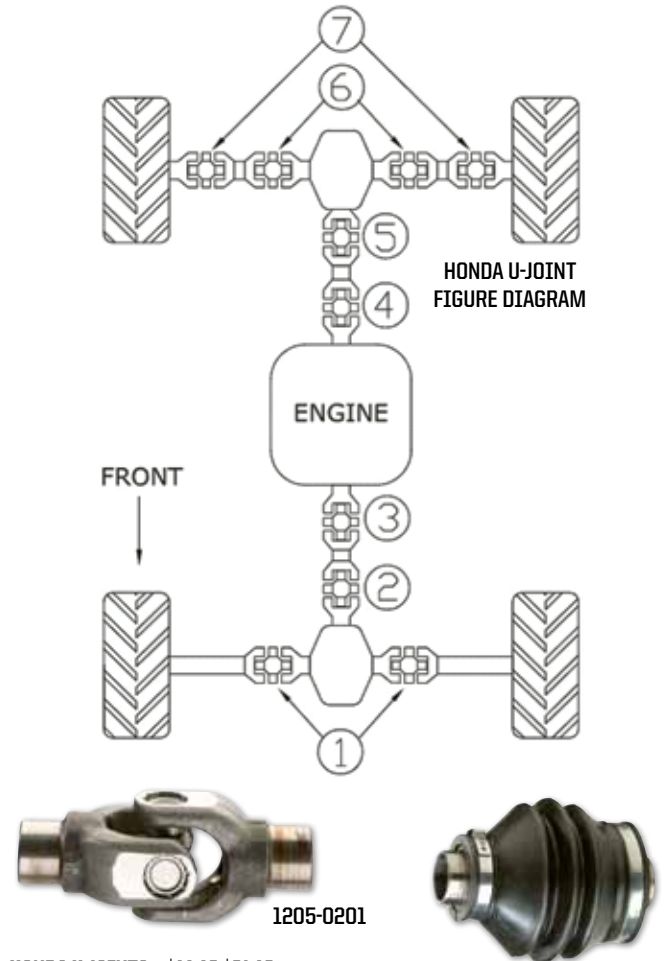

HONDA U-JOINTS > \$39.95-\$52.95
 Heavy duty joints replace stock shafts. Steel forgings have been strengthened where possible. All kits include 2 sealing O-rings. 1205-0201 & 1205-0202 upgraded u-joints from 17mm to 19mm. Overall 35% lower than OEM retail price. Imported.

FITS MODEL	LOCATION REFERENCE #	PART #	PART #
HONDA U-JOINTS			
HONDA			
TRX250 RECON 97-13	-	-	1205-0201
TRX300 FOURTRAX 300 88-00	-	-	1205-0201
TRX300FW FOURTRAX 4X4 88-00	-	-	1205-0201
TRX350D 87-89	1205-0201	-	-
TRX350FE/FM/TE/TM 00-06	-	-	1205-0201
TRX400FA/FGA 04-07	-	-	1205-0201
TRX400FW FOURTRAX FOREMAN 4X4 95-03	-	-	1205-0201
TRX420 FA/FPA 09-13	-	-	1205-0202
TRX420 FE/FM/TE/TM 07-13	-	-	1205-0202
TRX450ES/S 98-01	-	-	1205-0201
TRX450FE/FM 02-04	-	-	1205-0201
TRX500FA 01-13	-	-	1205-0201
TRX500FE 05-09	-	-	1205-0201
TRX500FGA 04-09	-	-	1205-0201
TRX500FM 05-11	-	-	1205-0201
TRX500FPA 09-13	-	-	1205-0201
TRX500FPE/FPM 08-11	-	-	1205-0201
TRX500TM 05-06	-	-	1205-0201
TRX650 RINCON 03-05	-	-	1205-0203
TRX680 RINCON 06-13	-	-	1205-0203

PLOWS
 WINCHES
 UTILITY
 RACKS
 LUGGAGE
 BODY
 CONTROLS
 ELECTRICAL
 WHEELS & TIRES
SUSPENSION & DRIVE
 ENGINE
 NRA BY MOOSE
 RIDER
 TOWING
 GARAGE
 PROMO

M.U.D.





- PROMO
- GARAGE
- TOWING
- RIDER
- NRA BY MOOSE
- ENGINE**
- SUSPENSION & DRIVE
- WHEELS & TIRES
- ELECTRICAL
- CONTROLS
- BODY
- LUGGAGE
- RACKS
- UTV
- WINCHES
- PLOWS



OIL FILTERS > \$5.95-\$8.95

High-quality replacement for your standard filter. Manufactured with sealing ring to ensure perfect fit. Can filter down to 10 microns. Offers maximum protection and long lasting filter life. May be used with conventional and synthetic oils. Imported.

FITS MODEL	PART #
OIL FILTERS	
ARCTIC CAT	
250 99-05	0712-0279
300 2X4, 4X4 98-05	0712-0279
350/366 10-11	0712-0272 ¹
400 2X4, 4X4/AUTO 98-08	0712-0280 ¹
425 CR 11-13	0712-0272 ¹
450 ATV/TRV 11-13	0712-0272 ¹
454 2X4, 4X4 96-98	0712-0280 ¹
500 4X4 AUTO 96-98	0712-0280 ¹
500 4X4 AUTOTRV 08-09	0712-0272 ¹
550 HI/TRV 09-13	0712-0272 ¹
600 4X4, LE 04	0712-0277 ¹
650 HI 4X4 AUTO LE, TBX, TRV PLUS, LE 07-12	0712-0272 ¹
650 PROWLER HI/XT 06-12	0712-0272 ¹
650 V-TWIN 4X4 AUTO, AUTO LE 04-06	0712-0277 ¹
700 EFI 4X4 AUTO, M4 TRV LE 08-09	0712-0272 ¹
700 HI/XT/TRV EFI 4X4 AUTO SE 08-13	0712-0272 ¹
THUNDERCAT 1000 08-09	0712-0272 ¹
ATV1000 4X4/TRV CRUISER/MUD PRO 08-13	0712-0272 ¹
CAN-AM	
330 OUTLANDER 04-05	0712-0357
400 OUTLANDER 04-09	0712-0357
500 EFI/XT OUTLANDER 08-12	0712-0357
500 RENEGADE 08-12	0712-0357
650 EFI/XT/MAX OUTLANDER 06-12	0712-0357
800 EFI/XT/MAX OUTLANDER 06-12	0712-0357
800 X RENEGADE 07-12	0712-0357
HONDA	
TRX200 D FOURTRAX 89-98	0712-0221
TRX300 ZWD 88-98	0712-0221
TRX300/300FW 4X4 87-01	0712-0221
TRX350 RANCHER ALL 00-06	0712-0221
TRX350/D FOURTRAX/FOREMAN 86-89	0712-0221
TRX400/450 FOURTRAX/FOREMAN 95-08	0712-0221
TRX400 RANCHER AT 04-07	0712-0274
TRX420 FE/FM 07-13	0712-0221
TRX420 FPA/FPE/FPM RANCHER 09-12	0712-0221
TRX420 TE/TM RANCHER 07-12	0712-0221
TRX500 RUBICON, FOURTRAX 01-13	0712-0274
TRX500 FOREMAN 05-13	0712-0221
TRX650 RINCON 03-05	0712-0274
TRX680 RINCON 06-13	0712-0274
KAWASAKI	
KLT200 80-84	0712-0276
KLF220 BAYOU 88-02	0712-0276
KLF250 BAYOU 03-09	0712-0276
KLF300 BAYOU 86-05	0712-0276
KVF300 PRAIRIE 99-02	0712-0278 ¹
KVF360 PRAIRIE ALL 02-13	0712-0277 ¹
KLF400 BAYOU 93-98	0712-0278 ¹
KVF400 PRAIRIE 97-02	0712-0278 ¹
KAF450/540 MULE ALL	0712-0278 ¹
KVF650 BRUTE FORCE, PRAIRIE ALL	0712-0277 ¹
KFX700 /V-FORCE 04-09	0712-0277 ¹
KVF700 PRAIRIE 04-06	0712-0277 ¹
KVF750 BRUTE FORCE/4X4 05-13	0712-0277 ¹
KRF750 TERYX 4X4/ 4X4 LE 08-13	0712-0277 ¹
POLARIS	
300 HAWKEYE 06-07	0712-0278 ¹
300 SPORTSMAN 08-09	0712-0278 ¹
325 MAGNUM, TRAIL BOSS, XPEDITION 00-02	0712-0278 ¹
330 ATP, MAGNUM, TRAIL BOSS, HAWK 03-13	0712-0278 ¹
330 TRAIL BLAZER 08-13	0712-0278 ¹

FITS MODEL	PART #
OIL FILTERS (CON'T)	
POLARIS (CON'T)	
335 SPORTSMAN 99-01	0712-0278 ¹
400 SPORTSMAN 01-05	0712-0278 ¹
400 SPORTSMAN/HAWKEYE 08-13	0712-0278 ¹
440L XPLORER 96-01	0712-0278 ¹
425 MAGNUM 2X4 4X4 6X6 95-98	0712-0278 ¹
425 XPEDITION 00-02	0712-0278 ¹
450 SPORTSMAN 06-07	0712-0278 ¹
500 ATP 04-05	0712-0278 ¹
500 RANGER 06-09	0712-0278 ¹
500 SPORTSMAN HO 6X6 X2/X2 EFI HO 00-09	0712-0278 ¹
500 EXPLORER 4X4 06-09	0712-0278 ¹
600 SPORT TWIN (BUILT AFTER 10/02/03) 04-05	0712-0273 ¹
700 RANGER 6X6 EFI/ CREW HD/XP 05-10	0712-0273 ¹
700 SPORTSMAN TWIN, EFI 04-09	0712-0273 ¹
800 SPORTSMAN EFI, X2, TWIN 05-13	0712-0273 ¹
800 RANGER RZR 08-13	0712-0273 ¹
SUZUKI	
LT160 ALL 91-04	0712-0279
LT230 ALL 85-93	0712-0279
LT/LT-F 4WD ALL 87-99	0712-0279
LT250 85-86	0712-0279
LT250 88-02	0712-0279
LT250 OZARK 02-12	0712-0279
LT300E ALL 87-89	0712-0279
LT300 KING QUAD 00-02	0712-0279
LT-F400 EIGER ALL 02-07	0712-0280 ¹
LT-A400 EIGER ALL 02-07	0712-0280 ¹
LT-A400F K7 EIGER 4X4 AUTO 07	0712-0280 ¹
LT-A400F KINGQUAD AUTO 4 X 4/CAMO 08-12	0712-0280 ¹
LT-F400F KINGQUAD 4X4/CAMO 08-12	0712-0280 ¹
LT-A450X K7 KING QUAD 4X4 07-11	0712-0280 ¹
LT-A /LT-F500 QUADRUNNER/VINSON ALL	0712-0280 ¹
LT700 KING QUAD 05-08	0712-0277 ¹
LTV700F-K4 TWIN PEAKS 04-05	0712-0280 ¹
LT-A750X KING QUAD 08-12	0712-0280 ¹
YAMAHA	
YTM200/225/250 ALL	0712-0281
YFB230/250 ALL	0712-0281
YFM250 BIG BEAR/BRUIN ALL	0712-0281
YFM350 87-07	0712-0283
YFM350 BRUIN AUTO 04-06	0712-0278 ¹
YFM350 GRIZZLY 07-13	0712-0277 ¹
YFM400 GRIZZLY 07	0712-0277 ¹
YFM400 KODIAK 94-99	0712-0283
YFM400 KODIAK 00-06	0712-0278 ¹
YFM400 BIG BEAR 93-12	0712-0283
YFM450 GRIZZLY 07-13	0712-0277 ¹
YFM450 KODIAK 03-06	0712-0278 ¹
YFM550F GRIZZLY 09-13	0712-0277 ¹
YFM600 GRIZZLY 98-01	0712-0282
YFM660 GRIZZLY ALL 02-07	0712-0278 ¹
YFM660 F-W GRIZZLY AUTO 4X4 07-08	0712-0277 ¹
YXR660 RHINO 04-06	0712-0278 ¹
YFM700 GRIZZLY 07-12	0712-0277 ¹
¹ SPIN ON FILTER	
MAGNETIC ENGINE DRAIN PLUGS > \$22.95	
Made of 7075 lightweight aluminum. Prolong engine life by pulling metal filings out of the oil. Ultra powerful magnets. Comes with either O-ring or washer sealing surface. Anodized red, unless noted. Made in the USA.	
FITS MODEL	
MAGNETIC ENGINE DRAIN PLUGS	
KAWASAKI	
KLF220 BAYOU 88-11	0920-0040
KLF300 BAYOU 86-04	0920-0040
KFX300 LAKOTA 95-02	0920-0040
KVF300 PRAIRIE 99-02	0920-0040



FITS MODEL	PART #
MAGNETIC ENGINE DRAIN PLUGS (CON'T)	
KAWASAKI (CON'T)	
KVF360 PRAIRIE 03-11	0920-0040
KLF400 BAYOU 93-99	0920-0040
KVF650 PRAIRIE 02-03	0920-0040
KVF650 BRUTE FORCE ALL YEARS	0920-0040
KVF700 PRAIRIE 04-06	0920-0040
KFX700 ALL YEARS	0920-0040
KVF750 BRUTE FORCE 05-11	0920-0040
SUZUKI	
LTF400 EIGER 02-10	0920-0044 ¹
KING QUAD 700 05-08	0920-0044 ¹
LTV700 TWIN PEAKS 04-05	0920-0040
LTA750 08-10	0920-0040
YAMAHA	
GRIZZLY400 07	0920-0043
YFM400 KODIAK 00-06	0920-0043
GRIZZLY 450 07-10	0920-0043
WOLVERINE 450 08-10	0920-0043
KODIAK 450 03-06	0920-0043
RHINO 450 ALL YEARS	0920-0043
RHINO 660 ALL YEARS	0920-0042
YFM660 GRIZZLY 98-06	0920-0043

¹ COLOR IS SILVER



MAGNETIC DIFFERENTIAL DRAIN PLUGS > \$22.95

Made of 7075 lightweight aluminum. Prolong differential life by pulling metal filings out of the oil. Ultra powerful magnets. Comes with either O-ring or washer sealing surface. Anodized red, unless noted. Made in the USA.

FITS MODEL	PART #
FRONT DIFFERENTIAL MAGNETIC DRAIN PLUGS	
KAWASAKI	
PRAIRIE 360 03-11	0920-0044 ¹
PRAIRIE 650 02-03	0920-0044 ¹
PRAIRIE 700 04-06	0920-0044 ¹
BRUTE FORCE 750 05-11	0920-0044 ¹
YAMAHA	
YFM350 WOLVERINE 94-10	0920-0044 ¹
KODIAK 400 93-99	0920-0044 ¹
GRIZZLY 660 98-01	0920-0039

FITS MODEL	PART #
REAR DIFFERENTIAL MAGNETIC DRAIN PLUGS	
SUZUKI	
KING QUAD 700 05-08	0920-0043
TWIN PEAKS 700 04-05	0920-0044 ¹
LTA750 08-10	0920-0043
YAMAHA	
KODIAK 450 03-06	0920-0043
GRIZZLY 450 07-10	0920-0043
WOLVERINE 450 06-10	0920-0043
RHINO 450/660 ALL YEARS	0920-0039
GRIZZLY 660 98-08	0920-0043
GRIZZLY 700 07-10	0920-0043

¹ COLOR IS SILVER



CLUTCH FRICTION PLATES, STEEL DRIVE PLATES, AND CLUTCH SPRINGS

Clutch Friction Plates: features an exclusive high heat- resistance friction material for fade-free performance. Ready to install - no need to soak in oil. Designed to ensure ultra-smooth power delivery.

Steel Clutch Plates: made of steel, not aluminum. Won't expand and fade like stock OEM plates. 300% longer life than stock. Sold in sets of 6 or 7. May be used as OEM replacement.

Clutch Springs: precision wound using the finest chrome silicone wire. Heat-treated and shot peened for maximum life. Offers stronger performance than OEM springs. Imported.

FRICTION PLATES > \$29.95-\$119.95
STEEL DRIVE PLATES > \$29.95-\$119.95
CLUTCH SPRINGS > \$11.95

FITS MODEL	FRICTION PLATES PART #	STEEL DRIVE PLATES PART #	CLUTCH SPRINGS PART #
HONDA			
TRX200 SX 86-88	F70-5160	-	-
ATC250 85-88	F70-5161	-	-
TRX250 RECON 97-07	F70-5160	-	-
TRX250 TM/TE FOURTRAX RECON 02-13	F70-5160	-	-
TRX300 ALL MODELS 88-00	-	M80-7105-5	FHDS4-4
TRX350 ALL MODELS 86-89	-	M80-7105-5	-
TRX350 RANCHER 4X4 00-07	-	M80-7105-5	-
TRX400 FW 95-03	-	M80-7105-5	-
TRX450 FOURTRAX FOREMAN 99-01	-	M80-7105-5	FHDS23-4
TRX450 FOURTRAX FOREMAN 02-04	-	-	FHDS23-4
YAMAHA			
YFS200 BLASTER ALL MODELS 88-06	F70-5425	M80-7408-6	FHDS42-5
YFM225 85-89	-	-	FHDS2-6
YFM350 BIG BEAR ALL MODELS 87-93	F70-5454	M80-7409-6	FHDS58-5
YFM350 BIG BEAR 94-98	F70-5454	M80-7409-6	-
YFM400 BIG BEAR 4WD/2WD 01-06	-	M80-7409-6	FHDS80-5
YFM400 KODIAK 93-99	F70-5454	M80-7409-6	-

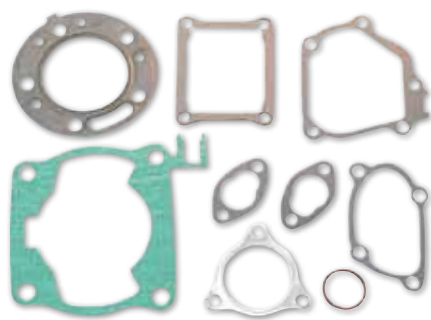

GASKETS > \$11.95-\$179.95

Each set includes high-performance head, base, intake and exhaust gaskets. Our performance sets are designed for a complete top-end rebuild. Made of high-tech materials providing unmatched reliability and performance. Clutch cover gaskets also available separately.

Made in the USA.

FITS MODEL	TOP END GASKET SET PART #	COMPLETE GASKET SET PART #	COMPLETE SET W/ OIL SEALS PART #	OIL SEAL SET PART #
GASKETS				
ARCTIC CAT				
90 2 CYCLE 03-05	0934-0084	-	-	-
250 ALL 2X4, 4X4 99-05	M810827	-	-	-
300 ALL 2X4, 4X4 98-05	M810826	M808826	-	-
400 MANUAL 98-02	M810800	-	-	-
400 MANUAL 03-08	M810846	-	-	-
400 AUTO 03-07	M810846	0934-0443	0934-0444	-

FITS MODEL	TOP END GASKET SET PART #	COMPLETE GASKET SET PART #	COMPLETE SET W/ OIL SEALS PART #	OIL SEAL SET PART #
GASKETS (CON'T)				
ARCTIC CAT (CON'T)				
454 MANUAL 96-98	M810800	-	-	-
500 MANUAL 99-09	M810828	M808828	M811828	-
500 AUTO 00-09	M810828	-	0934-0119	-
650 V- TWIN 04-07	0934-0693	0934-0681	0934-0701	0935-0022
650 HI 2005-10	0934-2076	0934-2064	0934-2084	-
1000 THUNDERCAT 08-10	0934-2077	0934-2065	0934-2085	-
CAN-AM				
OUTLANDER 500 09-11	0934-3016	-	0934-3018	0935-0545
OUTLANDER 650 07-11	0934-3016	-	0934-3018	0935-0545
OUTLANDER 800/800R 06-11	0934-3017	-	0934-3019	0935-0545
OUTLANDER 1000 ER 12	0934-3017	-	0934-3020	0935-0546
HONDA				
ATC185 80-83	M810816	-	-	-
ATC200 MANUAL START 81-82	M810816	-	-	0935-0391
ATC200X MANUAL START 83-85	M810816	-	-	0935-0391
ATC200S MANUAL START 84-86	M810816	-	-	0935-0391
TRX200 FOURTRAX 200 84	M810816	-	-	-
ATC200E, ES BIG RED 82-84	M810816	-	-	-
ATC200M 84-85	M810816	-	-	-
TRX200 FOURTRAX 86-97	M810817	-	-	0935-0382
ATC200X 86-87	M810817	-	-	0935-0382
TRX250 97-01	M810841	0934-0147	0934-0122	-
TRX250 FOURTRAX RECON ES, TE, TM 02-11	0934-0413	0934-1170	0934-1179	0935-0466
ATC250SX 85-87	M810802	M808802	M811802	M822168
ATC250ES BIG RED 85-87	M810802	M808802	M811802	M822168
TRX250 FOURTRAX 85-87	M810802	M808802	M811802	M822168
TRX300 FOURTRAX, FW 88-00	-	-	-	M822168
TRX350 FOURTRAX RANCHER ES 00-06	0934-0416	0934-0417	0934-0418	0935-0017
TRX400 FOREMAN FE, FM 95-03	0934-0092	0934-0153	0934-0125	0935-0018
TRX400FA, FGA 04-08	0934-1174	-	0934-1177	-
TRX420 RANCHER FM, TM, FPM, FE, TE, FPE 09-13	0934-2078	0934-2069	0934-2089	0935-0394
TRX420 RANCHER FA, FPA AUTO 09-13	0934-2078	0934-2072	0934-2092	0935-0396
TRX450FE, FM FOREMAN 02-04	0934-0093	0934-0154	0934-0126	0935-0019
TRX450S, ES 98-01	0934-0093	0934-0154	0934-0126	0935-0019
TRX500FA, FGA RUBICON 01-11	M810843	0934-0424	0934-0425	-
TRX500FE ELECTRIC SHIFT 05-11	0934-0697	-	0934-0708	-
TRX500FM, TM 05-11	0934-0697	0934-0689	0934-0709	0935-0384
KAWASAKI				
KLF220 BAYOU 88-02	M810803	M808803	M811803	M822138
KLF250 BAYOU 03-10	-	-	-	M822138
KEF300 LAKOTA 95-02	M810805	-	-	0935-0379
KLF300 BAYOU 86-04	M810805	-	-	0935-0380
KLF300 BAYOU 4X4 88-03	M810805	-	-	0935-0380
KVF300 PRAIRIE, 4X4 99-02	M810805	-	-	-
KVF360 PRAIRIE 03-12	M810845	-	0934-0123	-
KLF400 BAYOU 4X4 93-99	M810831	-	M811831	-
KVF400 PRAIRIE 4X4 97-02	M810831	-	-	-
KVF650 PRAIRIE 02-03	0934-0693	0934-0681	0934-0701	0935-0022
BRUTE FORCE 650 05-13	0934-0693	0934-0681	0934-0701	0935-0022
BRUTE FORCE 650 4X4 06-12	0934-0426	0934-0427	0934-0428	0935-0022
KFX700 V-FORCE 04-09	0934-0694	0934-0682	0934-0702	0935-0022
KVF700 PRAIRIE 04-06	0934-0694	0934-0682	0934-0702	0935-0022
BRUTE FORCE 750 I 05-12	0934-0426	0934-0427	0934-0428	0935-0022
TERYX 750 4X4 08-13	0934-0426	0934-0427	0934-0428	0935-0022
POLARIS				
90 SPORTSMAN 01-04	0934-0084	0934-0685	0934-0705	0935-0383
90 SPORTSMAN 05-06	0934-0084	-	-	-
90 SPORTSMAN 07-11	0934-1670	-	-	-
250 ALL 85-06	M810806	M808806	M811806	M822140
300 ALL 94-99	M810807	M808807	M811807	M822140
325 EXPEDITION 00-02	M810836	-	-	-
325 TRAIL BOSS, MAGNUM 00-02	M810836	M808836	M811836	M822143
330 TRAIL BOSS, MAGNUM 03-11	M810836	M808836	M811836	M822143
335 SPORTSMAN 99-00	M810837	-	-	M822143
350 90-93	-	-	-	M822142
400 ALL 94-02	M810808	M808808	M811808	M822142
400 SPORTSMAN 400 AUTO 01-05	M810821	M808821	M811821	M822143
425 MAGNUM AUTO 95-98	M810821	M808821	M811821	M822143
425 MAGNUM 6X6 AUTO 97	M810821	M808821	M811821	M822143
425 EXPEDITION MANUAL 00-02	M810821	-	-	-
450 SPORTSMAN 450 06-07	M810821	M808821	M811821	M822143

PLOWS
WINCHES
UTV
RACKS
LUGGAGE
BODY
CONTROLS
ELECTRICAL
WHEELS & TIRES
SUSPENSION & DRIVE
ENGINE
NRA BY MOOSE
RIDER
TOWING
GARAGE
PROMO

FITS MODEL	TOP END GASKET SET PART #	COMPLETE GASKET SET PART #	COMPLETE SET W/ OIL SEALS PART #	OIL SEAL SET PART #
GASKETS (CON'T)				
POLARIS (CON'T)				
500 SPORTSMAN 96-09	M810830	M808830	M811830	M822143
500 XPLORER 97	M810830	M808830	M811830	M822143
500 SPORTSMAN 6X6 98-08	M810830	M808830	M811830	M822143
500 MAGNUM 99-03	M810830	M808830	M811830	M822143
500 ATP 04-05	M810830	M808830	M811830	M822143
500 RANGER 2WD, 4WD, 6X6 02-06	M810830	M808830	M811830	M822143
500 SPORTSMAN, EFI, X2, HO 06-11	0934-0698	-	-	M822143
500 RANGER 4WD, EFI 06	0934-0698	-	-	M822143
700 SPORTSMAN, EFI (AFTER 10/02/03) 04-08	0934-2080	0934-2071	0934-2091	0935-0395
700 RANGER 05-09	0934-2080	0934-2071	0934-2091	0935-0395
800 SPORTSMAN, EFI 05-10	0934-2080	0934-2071	0934-2091	0935-0395
800 RANGER, RZR 08-09	0934-2080	0934-2071	0934-2091	0935-0395
SUZUKI				
LTF160 QUAD RUNNER 89-04	0934-0086	-	-	-
LT230E 87-93	M810809	-	M811809	-
LTF250 2WD 88-01	M810810	M808810	M811810	-
LT250 4WD 87-93	M810810	M808810	M811810	-
LTF250 4WD 88-02	M810810	M808810	M811810	-
LTF250 OZARK 02-10	0934-0695	0934-0684	0934-0704	-
LTF250 2WD 02	0934-0695	0934-0684	0934-0704	-
KING QUAD LTF300F 99-02	M810832	M808832	M811832	-
KING QUAD LTF3004WDX 91-98	M810832	M808832	M811832	-
EIGER LTF400 MANUAL 02-12	M810846	-	-	-
EIGER LTA400 AUTO 02-07	M810846	0934-0443	0934-0444	-
LTA400F 08-11	M810846	-	-	-
LTF500 MANUAL 98-07	M810828	M808828	M811828	-
LTA500 AUTO 00-07	M810828	-	0934-0119	-
TWIN PEAKS 700 04-05	0934-0694	0934-0682	0934-0702	0935-0022
YAMAHA				
YFM80 BADGER 85-01	0934-1431	0934-1428	-	-
YFM80 GRIZZLY 05-08	0934-1431	0934-1428	-	-
YFM125 BREEZE 91-04	0934-2075	0934-2063	-	-
YFM125 GRIZZLY 04-12	0934-2075	0934-2063	-	-
YFS200 BLASTER 88-06	M810811	M808811	M811811	M822153
YFB250 TIMBERWOLF 4X4 94-00	M810824	-	-	-
YFM250 BRUIN 2WD 05-06	M810824	-	-	-
YFB250 TIMBERWOLF 2WD 92-98	M810824	-	-	-
YFM250 BEAR TRACKER 2WD 99-04	M810824	-	-	-
YFM250 BIG BEAR 07-09	M810824	-	-	-
YFM350 BIG BEAR 4X4 97-99	M810813	0934-0155	0934-0127	-
YFM350 BRUIN 04-06	M810813	0934-0683	0934-0703	-
YFM350 GRIZZLY 07-10	M810813	0934-0683	0934-0703	-
YFM400 BIG BEAR 00-09	M810813	0934-0155	0934-0127	-
YFM400 KODIAK 99	M810813	0934-0155	0934-0127	-
YFM400 KODIAK 00-06	0934-0691	0934-0679	0934-0699	0935-0381
YFM400 GRIZZLY 07-08	0934-0691	0934-0679	0934-0699	0935-0381
YFM450 GRIZZLY 07-12	0934-0691	0934-0679	0934-0699	0935-0381
YFM450 KODIAK 03-06	0934-0691	0934-0679	0934-0699	0935-0381
RHINO 450 4X4 06-10	0934-0691	0934-0679	0934-0699	0935-0381
YFM450 WOLVERINE 06-10	0934-0691	0934-0679	0934-0699	0935-0381
YFM 550 GRIZZLY 12	-	-	-	0935-0392
YFM600 GRIZZLY 98-01	M810833	M808833	M811833	-
YFM660 GRIZZLY 02-08	0934-0432	0934-0433	0934-0434	0935-0024
RHINO 660 AUTO 4WD 04-07	0934-0432	0934-0433	0934-0434	0935-0024
YFM 700 GRIZZLY 07-12	0934-1704	0934-2068	0934-2088	0935-0392
YXR 700 RHINO 08-10,12	0934-1704	0934-2068	0934-2088	0935-0392

FITS MODEL				PART #
CLUTCH COVER GASKETS				
HONDA				
TRX200 86-97				0934-1414
ATC200 86-87				0934-1414
TRX250 RECON 97-07				0934-1409
TRX300 FOURTRAX 88-00				0934-1420
TRX400 FOREMAN 98-04				0934-1406
TRX450 FOREMAN 98-04				0934-1406
KAWASAKI				
KLF220, 250 BAYOU 88-10				0934-1424
SUZUKI				
LTF250 87-02				0934-1425
LTF250 03-09				0934-1412
YAMAHA				
YFM600 GRIZZLY 98-01				0934-1408



CRANK SHAFT BEARINGS > \$18.95-\$79.95
OEM matched, high-quality bearing/seal kit. Includes all bearings and seals required to do a crank at a fraction of OEM cost. Imported.

FITS MODEL	PART #
CRANK SHAFT BEARINGS	
HONDA	
ATC70 73-85	A24-1031 ¹
TRX70 86-87	A24-1031 ¹
ATC90 73-78	0924-0218
TRX90 93-13	A24-1031 ¹
ATC110 79-85	0924-0218
ATC125M 84-85	0924-0218
ATC125M 86-87	0924-0128 ¹
TRX125 85-86	0924-0218
TRX125 87-88	0924-0128 ¹
ATC185 80-83	0924-0128 ¹
ATC200E 82-84	0924-0128 ¹
ATC200ES 84	0924-0128 ¹
ATC200M 84-85	0924-0128 ¹
ATC200S 84-86	0924-0128 ¹
ATC200X 86-87	0924-0128 ¹
TRX200 84	0924-0128 ¹
TRX200, TRX200D 90-91	0924-0128 ¹
TRX200, TRX200D 96-97	0924-0128 ¹
TRX200D 92-95	0924-0128 ¹
TRX200SX 86-88	0924-0128 ¹
TRX250 RECON 97-13	0924-0050 ¹
KAWASAKI	
KLF110 87-88	A24-1031 ¹
KLT110 84-86	A24-1031 ¹
KLT160 85	0924-0218
KLF185 BAYOU 85-88	0924-0218
KLT185 86-87	0924-0218
KLT200B 83	A24-1042
KLT200C 83-84	A24-1042
KLF220 BAYOU 88-02	A24-1042
KLF250 BAYOU 03-11	A24-1042
KLT250C 83-85	A24-1042
KLF300A BAYOU 86-87	A24-1042
KLF300B BAYOU 88-91	A24-1042
POLARIS	
SPORTSMAN 90 01-06	0924-0048
SPORTSMAN 90 07-13	A24-1031 ¹
SPORTSMAN 335 99-00	0924-0104
400L 2X4 94-95	0924-0049
400L 4X4 94	0924-0049
SPORTSMAN 400 4X4 94-97	0924-0049
SPORTSMAN 400 4X4 01-02	0924-0104
SPORTSMAN 400 4X4 03	0924-0105
SPORTSMAN 400 4X4 AA AE AG 04	0924-0105
TRAIL BLAZER 400 03	0924-0049
XPLORER 400L 4X4 95-99	0924-0049
XPLORER 400L 4X4 00-02	0924-0049
XPRESS 400L 2X4 96-97	0924-0049
MAGNUM 425 2X4 95-98	0924-0104
XPEDITION 425 00-02	0924-0050 ¹
MAGNUM 500 2X4 HDS 02	0924-0104
MAGNUM 500 4X4 99-01	0924-0104
MAGNUM 500 4X4 HDS 01	0924-0104
MAGNUM 500 4X4 HDS 03	0924-0104
MAGNUM 500 4X4 HDS, MAGNUM 500 4X4 02	0924-0104
SPORTSMAN 500 4X4 96-98	0924-0104
SPORTSMAN 500 4X4 00	0924-0104
SPORTSMAN 500 4X4 99	0924-0104
SPORTSMAN 500 4X4 HO 01-03	0924-0105
SPORTSMAN 500 4X4 HO AA- AC- AE- AG 04	0924-0105
XPLORER 500 97	0924-0104
BIG BOSS 400L 6X6 94-97	0924-0049
MAGNUM 400L 6X6 96-97	0924-0104
BIG BOSS 500 6X6 98-99	0924-0104
BIG BOSS 500 6X6 00-02	0924-0104
SPORTSMAN 500 6X6 00-02	0924-0104
SPORTSMAN 500 6X6 03	0924-0105

CONTINUED ON NEXT PAGE

FITS MODEL	PART #
CRANK SHAFT BEARINGS (CON'T)	
SUZUKI	
LT-50 84-87	0924-0102
LT-A50 02-05	0924-0102
LT-80 87-06	0924-0113
ALT-125 83-86	A24-1036
LT-125 83-87	A24-1036
LT-160 03-04	A24-1036
LT-160E 89-92	A24-1036
LT-F160 91-01	A24-1036
ALT-185F 85	A24-1036
LT-185 84-87	A24-1036
LT-230E 87-93	A24-1036
LT-230GE 85-86	A24-1036
LT-230S 85-88	A24-1036
LT-F230 86-87	A24-1036
LT-250S 89-90	A24-1036
LT-4WD 250 87-98	A24-1036
LT-F250 88-98	A24-1036
LT-F250 QZARK 02-12	A24-1036
LT-F250, LT-F250F 99-01	A24-1036
LT-F250F 02	A24-1036
LT-F4WD 250 97-98	A24-1036
LT-F300F KING QUAD 99-02	A24-1036
LT-F4WDX KING QUAD 300 91-98	A24-1036
LT-F400 EIGER 2WD 02-04	0924-0050 ¹
LT-F400 EIGER 2WD 07	0924-0050 ¹
LT-F400F 4WD KING QUAD 08-11	0924-0050 ¹
LT-F400F EIGER 4WD 02-07	0924-0050 ¹
YAMAHA	
YFM700 GRIZZLY 07-13	0924-0210

JET KIT/IGNITION MODULE KIT > \$112.95-\$242.95

The digital ignition is preprogrammed with a performance advance curve while at the same time increasing the vehicle's rev limit. On modified vehicles where the engine makes power right up to redline the increased rev limit will allow for peak performance and additional top end power. Made in the USA.



FITS MODEL	PART #
JET KIT/IGNITION MODULE KIT	
KAWASAKI	
PRAIRIE 650 02	2101-0109
BRUTE FORCE 650 05-10	2101-0113
PRAIRIE 700 04-06	2101-0111
KFX700 03-09	2101-0112
BRUTE FORCE 750 05-07	2101-0114
YAMAHA	
GRIZZLY 660 02-08	2101-0100
RHINO 660 04-07	2101-0098

POWER MODULE > \$99.95

Waterproof plug and play device. Bypasses restrictions placed on power output at low speeds. Uses OEM style connectors. No cutting or soldering needed. Removing the Power Module returns the vehicle to stock configuration; no permanent changes are made. Made in the USA.



DESCRIPTION	PART #
ATV POWER MODULE	
ARCTIC CAT	
650 V-TWIN AUTO 04-06	2101-0064
KAWASAKI	
KVF650 BRUTE FORCE 05-09	2101-0064
KVF650I BRUTE FORCE 06-09	2101-0064
KVF650 PRAIRIE 02-03	2101-0064
KVF700 PRAIRIE 04-06	2101-0064
KVF750I BRUTE FORCE 02-07	2101-0064
SUZUKI	
LT700 TWIN PEAKS 04-05	2101-0064

POWER COMMANDER III USB > \$359.95

USB port provides an instant, problem-free way to connect your Power Commander to a computer. Provides precise information for fine tuning a fuel injected ATV when changing an air filter, installing a new exhaust system or doing additional engine performance modifications.



Includes a built in microprocessor and a specific map designed to improve engine performance over stock; Dynojet continuously maps new calibrations for downloading on their website (www.powercommander.com). If you do not have a computer you can change the settings with three touch buttons on the faceplate. OEM style wiring connectors with improved harness protection are supplied. Easy to follow instructions included. Software is compatible with Windows 98se/ME/2000/XP; opens all maps with .djm extension. USB special cable and 9V battery power adapter are included. Made in the USA.

FITS MODEL	PCIII PART #
POWER COMMANDER III USB	
ARCTIC CAT	
PROWLER 1000 08	1020-0638
700 EFI QUAD 06-07	1020-0353
700 H1 08	1020-0905
CAN-AM	
OUTLANDER 500 07-08	1020-0621
OUTLANDER 650 06-08	1020-0767
OUTLANDER 800 06-08	1020-0269
HONDA	
RANCHER 420 07-08	1020-0354
RINCON 680 06-08	1020-0270
KAWASAKI	
BRUTE FORCE 750 08	1020-0642
POLARIS	
700 TWIN EFI 04	1020-0084
700 TWIN EFI 05-08	1020-0140
RANGER XP 06-08	1020-0328
SUZUKI	
KINGQUAD 450 07-08	1020-0356
KINGQUAD 700 EFI 05-07	1020-0142
KINGQUAD 750 08	1020-0833
YAMAHA	
GRIZZLY 700 07-08	1020-0357
RHINO 700 08	1020-0644

POWER KITS > \$132.95-\$230.95

Kit includes a K&N filter, jet kit, Outerwear's water repellent prefilter, and a K&N service kit. Available for both sport and utility ATV's. Made in the USA.



FITS MODEL	PART #
POWER KITS	
HONDA	
TRX250 RECON 02-10	MPK105-1
TRX450 FOREMAN 98-04	MPK106
TRX500 FOREMAN 05-10	1007-0158
TRX500 RUBICON 00-05	MPK109
TRX500 RUBICON 06-10	1007-0213
TRX650 RINCON 03-05	MPK112
KAWASAKI	
KVF650 PRAIRIE 02	MPK210
KFX700 V-FORCE 03-09	1007-0078
KVF750 05-07	1007-0160
POLARIS	
PHOENIX 200 05-06	1007-0214
PHOENIX 200 07-10	1007-0312
SPORTSMAN 300 08-10	1007-0314
YAMAHA	
BIG BEAR 350 99	MPK411
RHINO 450 06-09	1007-0316
YFM450 KODIAK 03-06	1007-0198
RHINO 660 04-07	1007-0166
GRIZZLY 660 02-08	MPK415

PLOWS
WINCHES
UTV
RACKS/S
LUGGAGE
BODY
CONTROLS
ELECTRICAL
WHEELS & TIRES
SUSPENSION & DRIVE
ENGINE
NRA BY MOOSE
RIDER
TOWING
GARAGE
PROMO



POWER COMMANDER V

> \$379.95-\$390.95

Less than half the size of the PCIII USB. USB powered from computer (9V adapter no longer needed for programming). Two-position map switching function built in (map switch not included). Gear/speed input allows for map adjustment based on gear and speed. Analog input allows user to install any 0-5V sensor and build an adjustment table based on its input such as boost or temperature. With gear-position connected, the PCV is capable of allowing each cylinder to be mapped individually and for each gear. Unit has a -100/+250% fuel change range (up from -100/+200%), which allows more adjustment.

Ten throttle position columns (up from nine on PCIII USB). Enhanced "accel pump" utility (increased adjustment and sensitivity ranges).

Made in the USA.

FITS MODEL	PCV PART #
POWER COMMANDER V	
ARCTIC CAT	
450 HI 10	1020-1466
550 HI 09-10	1020-1036
700 HI 09-10	1020-1037
THUNDERCAT 1000 08-13	1020-1163
THUNDERCAT 1000 08-13	1020-1773 ¹
PROWLER 1000 09-13	1020-1038
WILDCAT 1000 12-13	1020-1774
CAN-AM	
OUTLANDER 400 09-12	1020-1250
OUTLANDER 500 09-12	1020-1710
OUTLANDER 650 09-11	1020-1711
OUTLANDER 800 12	1020-1630
COMMANDER 800 11-12	1020-1725 ¹
COMMANDER 1000 11-12	1020-1547 ¹
RENEGADE 1000 12-13	1020-1724
OUTLANDER 1000 12	1020-1630
HONDA	
RANCHER 420 09-13	1020-1165
FOREMAN 500 12	1020-1697 ¹
RINCON 680 09-13	1020-1166
BIG RED 09-12	1020-1775 ¹
KAWASAKI	
BRUTE FORCE 750 09-12	1020-1035
BRUTE FORCE 750 12-13	1020-1709 ¹
BRUTE FORCE 750 08-11	1020-1777 ¹
TERYX 750 09-11	1020-1008
TERYX 750 09-12	1020-1708 ¹
POLARIS	
SPORTSMAN 550 XP 09-12	1020-1744 ¹
SPORTSMAN 800 05-10	1020-1251
SPORTSMAN 850 09-11	1020-1130
SPORTSMAN 850 09-11	1020-1575 ¹
SPORTSMAN 850 12	1020-1698
RZR 570 12-13	1020-1778
RZR 800 S 09-10	1020-1009
RZR & RZR 800 S 08-10	1020-1574 ¹
RZR 800 S 11-12	1020-1536 ¹
RZR XP900 11	1020-1625 ¹
RZR XP900 12-13	1020-1695 ¹
SUZUKI	
KINGQUAD 400 11-12	1020-1474
KINGQUAD 500 11-12	1020-1475
KINGQUAD 750 10-12	1020-1779
YAMAHA	
GRIZZLY 550 09-12	1020-1168
GRIZZLY 700 09-12	1020-1010
RHINO 700 09-12	1020-0907
RHINO 700 08-12	1020-1745 ¹

¹ WITH BUILT IN IGNITION AND FUEL CONTROL



CARB REPAIR

KITS > \$12.95-\$65.95

Complete kit to rebuild OEM carburetors. Imported.

FITS MODEL	PART #
CARB REPAIR KITS	
ARCTIC CAT	
250 2X4/4X4 02-05	1003-0336
300 2X4 01-03	1003-0338
300 4X4 01-05	1003-0338
400 AUTO 2X4 04	1003-0339
400 AUTO 4X4 04-06	1003-0339
500 AUTO 4X4 05-07	1003-0341
650 HI 4X4 05-06	1003-0342
HONDA	
ATC70 78-82	MD03-001
TRX70 FOURTRAX 86-87	MD03-035
ATC90 72-78	MD03-002
TRX90 93-98	1003-0018
TRX90 99-06	1003-0156
ATC110 79-83	MD03-003
ATC110 84-85	MD03-024
ATC125M 84-85	MD03-025
TRX125 FOURTRAX 85-86	MD03-004
TRX125 FOURTRAX 87-88	MD03-005
ATC185S 83	MD03-026
ATC200 83	MD03-026
ATC200ES BIG RED 84	MD03-027
ATC200M 84-85	MD03-027
ATC200E BIG RED 82-83	MD03-027
ATC185/S 80-82	MD03-006
ATC200 81-82	MD03-006
ATC200S 84-86	MD03-007
ATC200X 83-85	MD03-008
ATC200X 86-87	MD03-009
TRX200SX FOURTRAX 87-88	MD03-010
TRX200SX 86	1003-0282
TRX200D FOURTRAX 91	MD03-032
TRX200 FOURTRAX 84	MD03-036
TRX200 FOURTRAX 90-91	MD03-032
TRX200D FOURTRAX 92-93	MD03-033
TRX200D FOURTRAX 94-96	MD03-034
TRX250TE/TM 06-09	1003-0213
ATC250ES/SX BIG RED 86-87	MD03-028
ATC250ES/SX 85	MD03-015
TRX250 FOURTRAX 85	MD03-016
TRX250 FOURTRAX 86-87	MD03-017
TRX250/ES 97-05	1003-0024
TRX250TE/TM 02-05	1003-0024
TRX300/FW FOURTRAX 88-90	MD03-021
TRX300/FW FOURTRAX 91-92	MD03-029
TRX300 FOURTRAX 93-00	MD03-031
TRX350 RANCHER ALL 00-03	1003-0001
TRX350/D FOURTRAX 86-88	MD03-023
TRX350 04-06	1003-0215
TRX400FW FOREMAN 95-03	MD03-037
TRX400FA/FGA 04-07	1003-0095
TRX450ES/S 98-03	1003-0017
TRX500FA/FGA RUBICON 01-04	1003-0025
TRX500 FOREMAN 05-09	1003-0157
TRX500FA/FGA 05-09	1003-0217
TRX650 03-05	1003-0096
KAWASAKI	
KSF50 03-06	1003-0221
KSF80 03-06	1003-0158
KSF90 07-09	1003-0218
KLF220 BAYOU 88-02	MD03-101
KLF250 03-06	1003-0092
KLF250 07-11	1003-0283
KLF300 BAYOU 86-88	MD03-103
KLF300 BAYOU 89-04	MD03-104
KLF300 BAYOU 4X4 89-04	MD03-105
KVF300 PRAIRIE 99-02	1003-0028
KEF300 95-03	1003-0219
KVF360 03-07	1003-0093

FITS MODEL	PART #
CARB REPAIR KITS (CON'T)	
KAWASAKI (CON'T)	
KSF400 03-06	1003-0182
KVF400 PRAIRIE 99-02	1003-0029
KLF400 BAYOU 93-95	1003-0026
KLF400 BAYOU 96-99	1003-0027
KVF650 02-09	1003-0094 ¹
KVF700 04-06	1003-0094 ¹
KSV700 04-09	1003-0177 ¹
KVF750 05-07	1003-0220 ¹
POLARIS	
SPORTSMAN 90 08	1003-0347
SPORTSMAN 90 09-11	1003-0345
TRAIL BLAZER 90-95	1003-0004
TRAIL BLAZER 96-00	1003-0080
XPLORER 4X4 00	1003-0080
TRAIL BOSS 2X4 89-93	1003-0004
TRAIL BOSS 4X4 89-93	1003-0004
TRAIL BOSS 89-99	1003-0004
PHOENIX 200 05-09	1003-0229
XPLORER 300 96-99	1003-0005
XPRESS 300 96-99	1003-0005
4X4 300 94-95	1003-0005
2X4 300 94-95	1003-0005
MAGNUM 325 2X4 00-02	1003-0348
MAGNUM 325 4X4 00-02	1003-0348
TRAIL BOSS 325 00-01	1003-0348
MAGNUM 330 2X4 03-05	1003-0159
MAGNUM 330 4X4 03-05	1003-0159
TRAIL BOSS 330 03-05	1003-0159
SPORTSMAN 335 99-00	1003-0349
TRAIL BOSS 4X4 350L 92-93	1003-0006
TRAIL BOSS 2X4 350L 92-93	1003-0006
SPORTSMAN 4X4 93	1003-0006
XPLORER 400 4X4 95	1003-0007
4X4 400L 94	1003-0007
2X4 400L 94	1003-0007
XPLORER 400 97-02	1003-0082
SPORTSMAN 400 01-02	1003-0230
SPORTSMAN 400 03-05	1003-0231
SPORTSMAN 400 HO 08-09	1003-0232
SPORTSMAN 450 06-07	1003-0232
SPORTSMAN 500 4X4 94-95	1003-0007
SPORTSMAN 500 02	1003-0083
SPORTSMAN 500 03-05	1003-0160
SPORTSMAN 500 99-00	1003-0234
SPORTSMAN 700 02-06	1003-0235
RANGER 500 4X4 04-06	1003-0350
SUZUKI	
LTA50 02-05	1003-0221
LT125 QUADRUNNER 83-87	MD03-201
ALT125 TRAIL BUDDY 83-86	MD03-201
LT160E 89-92	MD03-208
LT160 91-00	MD03-208
LT185 84-87	1003-0178
LTF230 QUADRUNNER 86-87	MD03-204
LT230GE QUADRUNNER 85-86	MD03-204
LT230E QUADRUNNER 89-93	MD03-205
LTF250 00-01	1003-0161
LTF250F 00-02	1003-0161
LTF250 03-09	1003-0162
LTF250 QUADRUNNER 88-89	MD03-206
LTF250 QUADRUNNER 90-96	MD03-207
LTF250 QUADRUNNER 97-99	1003-0030
LTF250F 99	1003-0030
LTF4WD 97-98	1003-0030
LT4WD QUADRUNNER 87-89	MD03-206
LT4WD QUADRUNNER 90-96	MD03-207
LTF4WDX KING QUAD 91-98	MD03-209
LTF300F 99	MD03-209
LTF300F 00-02	1003-0181
LTA400 EIGER 03-07	1003-0084
LTF400 EIGER 03-07	1003-0084
LTA400F 08-09	1003-0284
LTF400F 08-09	1003-0284
LTF-500 98-02	1003-0031
LTA500F 02-07	1003-0163
LTF-500 03-07	1003-0163

CONTINUED ON NEXT PAGE

FITS MODEL	PART #
CARB REPAIR KITS (CON'T)	
YAMAHA	
YFM50/R 04-08	1003-0223
YFM80/R 92-08	1003-0032
YFA-1 89-04	1003-0164
YFM125 04-06	1003-0164
YFM125G 07-12	1003-0285
YFM200 86-89	1003-0033
YFM250 99-04	1003-0097
YFM250 MOTO-4 89-91	MD03-302
YFB250F TIMBERWOLF 96-98	MD03-306
YFB250/U TIMBERWOLF 92-98	MD03-306
YFM250B 05-09	1003-0224
YFM250R 08-09	1003-0225
YFM350F/FW BIG BEAR 89-92	MD03-304
YFM350ER MOTO-4 89-93	MD03-304
YFM350/4WD BRUIN 04-06	1003-0183
YFM350R 04-08	1003-0184
YFM350FX 01-05	1003-0226
YFM350F 98-99	1003-0286
YFM350U 99	1003-0286
YFM400F/FW KODIAK 93-95	MD03-304
YFM400 KODIAK 96-98	1003-0034
YFM400 KODIAK 00-04	1003-0036
YFM400 BIG BEAR 00-12	1003-0035
YFM450 KODIAK 03-06	1003-0098
YFM450FG GRIZZLY 07-12	1003-0288
YFM600 GRIZZLY 98-01	1003-0037
YFM660 GRIZZLY 02-05	1003-0099
YFM660F 06-08	1003-0289
YXR450F RHINO 06-09	1003-0227
YXR660F RHINO 04-07	1003-0228

¹ PARTS INCLUDED FOR TWO CARBURETORS



JET KITS > \$59.95-\$82.95

Stage 1: Intended for ATV's with a stock engine using the stock air box, air filter and stock pipe. Stage 1 kits are fully adjustable to allow the use of a well designed aftermarket pipes and stock replacement air filters like K&N. In most cases power increases of approximately 5% throughout the entire power range can be achieved.

Stage 2: Intended for ATV's with a stock or mildly tuned engine using a well designed aftermarket pipe with a modified air box and a stock replacement air filter. Stage 2 kits are designed for applications where individual filters cannot be installed and for applications where air box modification improves the engine's performance. In most cases power increases of approximately 8% can be achieved.

Stage 3: Intended for ATV's with stock or mildly tuned engines using a well designed aftermarket pipe and individual air filters. In most cases power increases of 10-15% can be achieved. However drive ability may be compromised particularly with short stroke, high rpm motors. On some modern engine and air box designs, individual filters and proper jetting offer no performance improvement yet compromise drive ability, in such cases stage 3 kits are not available. Made in the USA.

FITS MODEL	PART #
JET KITS	
ARCTIC CAT	
400 4X4 99-01	1 MQ605
400 2X4 & 4X4 AUTO TRANS 03-09	1 MQ622
400 2X4 & 4X4 STANDARD 03-07	1 MQ623
500 4X4 STANDARD 03-09	1 1007-0072
500 4X4 AUTO TRANS 03-09	1 MQ621
650 H1 AUTO TRANS 05-08	1 1007-0149
650 V-2 4X4 AUTO TRANS 04-05	1 1007-0133
CAN-AM	
OUTLANDER 400 H.O 04-08	1 1007-0296
HONDA	
TRX250 RECON 97-13	1 MQ105
TRX300FW 92-02	1 MQ103
TRX350 RANCHER 00-06	1 MQ108
TRX400 FW FOREMAN 96-03	1 MQ104
TRX400 RANCHER 04-06	1 1007-0073
TRX450 FW FOREMAN 98-04	1 MQ106
TRX500FW RUBICON 00-05	1 MQ109
TRX500 FW RUBICON 06-13	1 1007-0187
TRX500 FOREMAN/4X4/ES 05-11	1 1007-0122
TRX650 RINCON 03-05	1 MQ112
KAWASAKI	
KLF250 BAYOU 02-11	1 MQ212
BRUTE FORCE 300 12-13	1 1007-0381
KEF300 LAKOTA 95-04	1 MQ202
KLF300FW BAYOU 91-04	1 MQ205
KVF300 PRAIRIE 99-02	1 MQ208
KVF360 PRAIRIE 02-13	1 MQ211
KVF400 PRAIRIE 99-02	1 MQ209
PRAIRIE 650 02	1 MQ210
PRAIRIE 650 03	1 1007-0074
KVF650 BRUTE FORCE 05-13	1 1007-0132
KVF650I BRUTE FORCE 06-13	1 1007-0217
PRAIRIE 700 04-06	1 1007-0075
KFX700 V-FORCE 03-09	1 MQ214
KVF750 BRUTE FORCE 05-07	1 1007-0098
TERYX 750 4X4 LE 08	1 1007-0298

FITS MODEL	PART #
POLARIS	
200 PHOENIX 07-13	1 1007-0277
300 SPORTSMAN 08-10	1 1007-0302
330 TRAIL BOSS 10-13	1 1007-0378
400 SPORTSMAN HO 08-13	1 1007-0321
400 RANGER 10-13	1 1007-0353
500 SPORTSMAN 99-00	1 MQ505
500 SPORTSMAN H.O. 01-06	1 MQ513
500 SPORTSMAN H.O. 08-13	1 1007-0354
600 TWIN SPORTSMAN 03-05	1 MQ519
700 TWIN SPORTSMAN 02-06	1 MQ515

FITS MODEL	PART #
SUZUKI	
OZARK 250 02-13	2 MQ313
KINGQUAD 400 AUTO 08-09	1 1007-0356
KINGQUAD 400 STANDARD 08-10	1 1007-0355
EIGER 400 2X4 & 4X4 AUTO 02-07	1 MQ309
EIGER 400 2X4 & 4X4 02-07	1 MQ310
VINSON 500 4X4 02-07	1 MQ311

FITS MODEL	PART #
YAMAHA	
250 BIG BEAR 07-09	1 1007-0279
300 GRIZZLY 12-13	1 1007-0382
YFM350 FW WOLVERINE 96-05	1 MQ403
YFM350FW BIG BEAR 87-97	1 MQ404
350 BRUIN AUTO 2X4 & 4X4 04-06	1 1007-0124
350 GRIZZLY AUTO 2X4 & 4X4 07-11	1 1007-0280
350 GRIZZLY IRS AUTO 07-13	1 1007-0288
YFM400 KODIAK AUTO 2X4 & 4X4 00-06	1 MQ412
YFM400 BIG BEAR 2X4 & 4X4 00-06	1 MQ413
400 BIG BEAR IRS 07-12	1 1007-0289
YFM450 KODIAK AUTO 4X4 03-06	1 MQ420
450 GRIZZLY AUTO 07-13	1 1007-0282
YXR450 RHINO 06-09	1 1007-0307
YFM600 GRIZZLY 98-01	1 MQ407
YFM660 GRIZZLY 02-08	1 MQ415
YXR660 RHINO 04-07	1 1007-0119



- PLOWS
- WINCHES
- UTV
- RACKS
- LUGGAGE
- BODY
- CONTROLS
- ELECTRICAL
- WHEELS & TIRES
- SUSPENSION & DRIVE
- ENGINE
- NRA BY MOOSE
- RIDER
- TOWING
- GARAGE
- PROMO



AIR FILTERS > \$4.95-\$26.95

Same high-quality foam designed for racers. Engineered for maximum air flow while increasing horsepower. Maintains premium protection by stopping the finest dust particles. Filters are made of dual bonded foam for easier cleaning. Flexible seams that will not crack. Filters are designed to fit all stock air boxes. Made in the USA.

PPO (PRECISION PRE-OILED)

AIR FILTERS > \$4.95-\$26.95

Same high-quality Moose Racing filters available pre-oiled. High technology machine pre-oils filter to perfection while leaving no excess. Includes re-sealable filter bag. Made in the USA.

FITS MODEL	DRY PART #	PRE-OILED PART #
AIR FILTERS		
ARCTIC CAT		
250/300 ALL MODELS 98-00	M763-10-01	1011-2544
250/300 01-02	M763-10-02	1011-1398
400/500 ALL MODELS 98-02	M763-10-02	1011-1398
400/500 03-05	1011-0023	1011-2553
454 BEARCAT ALL MODELS 96-00	M763-10-02	1011-1398
400 TRV/TBX/FIS 05-09	1011-0564	1011-2546
500 FIS AUTO 03-04	1011-1126	-
500 TBX/FIS 04	1011-1126	-
500 TBX/FIS 05-08	1011-0564	1011-2546
500 TRV 03-05	1011-1126	-
500 TRV AUTO 06	1011-0564	1011-2546
650 H.I. 05-07	1011-0564	1011-2546
650 V-TWIN 04-07	1011-0564	1011-2546
PROWLER 650 06-07	1011-0564	1011-2546
PROWLER 650 HI 08-12	1011-1455	-
700 EXCL. DIESEL 06-12	1011-1125	-
PROWLER 700 HI 08-13	1011-1455	-
THUNDERCAT 1000 08-12	1011-1125	-
CAN-AM		
300 OUTLANDER 04-05	1011-1130	1011-2790
400 OUTLANDER 03-07	1011-1130	1011-2790
500 OUTLANDER 07-12	1011-1129	1011-2534
500 RENEGADE 08-12	1011-1129	1011-2534
650 OUTLANDER 06-08	1011-1129	1011-2534
800 OUTLANDER 06-08	1011-1129	1011-2534
800 RENEGADE 07-08	1011-1129	1011-2534
COMMANDER 800 11	1011-2796 ¹	-
COMMANDER 1000 11	1011-2796 ¹	-
E-TON		
IMPULSE TXL50/90 98	1011-0565	-
TXL 50/90 ALL YEARS	1011-0565	-
AXL 50/90 ALL YEARS	1011-0565	-
DX 90 ALL YEARS	1011-0565	-
HONDA		
ATC110 79-82	M763-20-04	1011-2547
ATC110 83-85	M763-20-05	1011-0854
ATC125M 84-85	M763-20-05	1011-0854
ATC125M 86	M763-20-06	1011-0855
TRX125 84-86	M763-20-05	1011-0854
TRX125M 87-88	M763-20-06	1011-0855
ATC185S 81-82	M763-20-04	1011-2547
ATC185S 83-85	M763-20-05	1011-0854
ATC200 81-82	M763-20-04	1011-2547
ATC200 83-85	M763-20-05	1011-0854
ATC200E 82-83	M763-20-05	1011-0854
ATC200ES 84	M763-20-05	1011-0854
ATC200M 84-85	M763-20-05	1011-0854
ATC200S 84-86	M763-20-05	1011-0854
ATC200X 83-85	M763-20-07	1011-2542
ATC200X 86-87	M763-20-08	1011-2545
TRX200 84-86	M763-20-05	1011-0854
TRX200 89-98	M763-20-09	1011-2551
TRX200SX 86-88	M763-20-06	1011-0855

FITS MODEL	DRY PART #	PRE-OILED PART #
AIR FILTERS (CON'T)		
HONDA (CON'T)		
TRX250D RECON 97-13	M763-20-14	1011-0858
TRX250 85-87	M763-20-12	1011-0857
TRX300 90-01	M763-20-17	1011-0860
TRX300FW 92-01	M763-20-17	1011-0860
FL350 ODYSSEY 85-86	M763-20-23	-
TRX350 RANCHER ALL 00-06	M763-20-21	1011-0863
FL400 PILOT 89-90	M763-20-18	-
TRX350 4X4 86-89	M763-20-19	1011-0861
TRX400 4X4 FOREMAN 95-04	M763-20-17	1011-0860
AT400 RANCHER 04-07	M763-20-21	1011-0863
TRX420 RANCHER 07-13	1011-1128	1011-1136
TRX450 ALL 98-06	M763-20-21	1011-0863
TRX500 RUBICON/FOREMAN 01-13	M763-20-20	1011-0862
TRX650/680 RINCON 03-13	M763-20-20	1011-0862
BIG RED 09-13	M763-20-20	1011-0862
KAWASAKI		
KLT160 85	M763-40-01	1011-1401
KLT185 86-87	M763-40-01	1011-1401
KLT200 81-84	M763-40-01	1011-1401
KLT250 82-85	M763-40-01	1011-1401
KLF185 BAYOU 86-88	M763-40-01	1011-1401
KLF220 BAYOU 88-01	M763-40-05	1011-0864
KLF250 BAYOU 03-11	M763-40-05	1011-0864
KLF300 BAYOU 86-88	M763-40-01	1011-1401
KLF 300 BAYOU 89-04	M763-40-06	1011-0865
KEF300 LAKOTA 95-03	M763-40-02	1011-2549
KVF300 PRAIRIE 99-03	M763-40-09	1011-1402
KVF360 PRAIRIE 02-13	1011-0020	1011-2539
KLF400 BAYOU 93-02	M763-40-07	-
KVF400 PRAIRIE 97-06	M763-40-09	1011-1402
KAF300 MULE ALL YEARS	M763-40-10	1011-1403
KAF520 MULE ALL YEARS (NON 4X4)	M763-40-10	1011-1403
KVF650 PRAIRIE 4X4 02	M763-40-11	-
KVF650 PRAIRIE 4X4 03-06	1011-0021	1011-2536
KVF650 BRUTE FORCE 05-13	1011-0021	1011-2536
KVF650 I BRUTE FORCE 05-13	1011-0457	1011-1137
KFX700 V-FORCE 04-09	1011-0021	1011-2536
KVF700 PRAIRIE 04-09	1011-0021	1011-2536
KVF750 I BRUTE FORCE 05-13	1011-0457	1011-1137
TERYX 750 09-13	1011-2038	1011-2039
KYMCO		
250/300 MXU/MONGOOSE 05-09	1011-2795	-
POLARIS		
SPORTSMAN 90 01-06	1011-1127	1011-2537
SPORTSMAN 90 07-13	1011-1456	-
RZR 170 11-13	1011-2787 ¹	-
REPLACEMENT FOAM		
SLEEVE FOR 1011-2787	1011-2788	-
SAWTOOTH 250 06-07	M763-15-04	1011-1400
HAWKEYE 250 06-07	M763-15-04	1011-1400
ALL 2-STROKE (EXCEPT 400L) 87-01	M763-15-01	1011-0852
ALL XPLORER 95-00	M763-15-01	1011-0852
XPLORER 01-02	M763-15-04	1011-1400
PHOENIX 200 06-13	M763-15-04	1011-1400
TRAILBLAZER 250 THRU 00	M763-15-01	1011-0852
TRAILBLAZER 250 01	M763-15-04	1011-1400
TRAILBOSS 250 THRU 01	M763-15-01	1011-0852
TRAILBLAZER 250 2-STR 02-09	M763-15-04	1011-1400
TRAILBLAZER 330 08-12	M763-15-04	1011-1400
SPORTSMAN 300 08-09	M763-15-04	1011-1400
MAGNUM 325-500 THRU 01	M763-15-05	1011-0853
MAGNUM 325-500 4-STR 02-03	M763-15-04	1011-1400
MAGNUM 330 03-06	M763-15-04	1011-1400
TRAILBOSS 325 THRU 00	M763-15-05	1011-0853
TRAILBOSS 325 4-STR 01-09	M763-15-04	1011-1400
TRAILBOSS 330 08-13	M763-15-04	1011-1400
XPEDITION 325-425 00-03	M763-15-05	1011-0853
SPORTSMAN 335-500-6X6 96-01	M763-15-05	1011-0853
SPORTSMAN 500 4-STR 02-13	M763-15-05	1011-0853
SPORTSMAN 400-4X4 & 6X6 02-13	M763-15-05	1011-0853
HAWKEYE 400 11-13	M763-15-05	1011-0853
MAGNUM 425 95-01	M763-15-02	1011-1399
SPORTSMAN 550 11-12	M763-15-05	1011-0853
SPORTSMAN 700 02-05	M763-15-05	1011-0853
700 X2 08-09	M763-15-05	1011-0853

FITS MODEL	DRY PART #	PRE-OILED PART #
AIR FILTERS (CON'T)		
POLARIS (CON'T)		
SPORTSMAN 800 06-13	M763-15-05	1011-0853
SPORTSMAN 850 XP 09-13	M763-15-05	1011-0853
RZR 800 08-13	1011-1994 ¹	-
REPLACEMENT FOAM		
SLEEVE FOR 1011-1994	1011-2783	-
RANGER 400/500 MIDSIZE 12-13	1011-1995 ¹	-
RANGER 800/900 11-13	1011-1994 ¹	-
RANGER 2X4/4X4/6X6 06-11 (ALL EXCEPT RZR)	1011-1995 ¹	-
REPLACEMENT FOAM		
SLEEVE FOR 1011-1995	1011-2784	-
RZR 570 12	1011-2789 ¹	-
RZR 900 EFI 11-13	1011-2789 ¹	-
SUZUKI		
LT80 87-06	M763-70-03	1011-0866
ALT/LT125 83-89	M763-70-04	1011-0867
ALT/LT185 84-89	M763-70-04	1011-0867
LT160 91-04	M763-70-05	1011-2538
LT250 QUADRUNNER 85-90	M763-70-06	1011-2548
LTF250 88-02	M763-70-07	1011-0868
LTF250 OZARK 03-12	M763-70-12	1011-1405
LTF300 KINGQUAD 99-03	M763-70-07	1011-0868
LTF 4WD KINGQUAD 91-03	M763-70-07	1011-0868
LT 4WD QUADRUNNER 87-03	M763-70-07	1011-0868
LT450 KINGQUAD + CAGE 07-11	1011-0561	1011-0883
LT450 KINGQUAD 07-11	1011-0562	1011-0884
LT400 EIGER QUADRUNNER 02-07	M763-70-10	1011-1404
KING QUAD 400 08-13	M763-70-10	1011-1404
LT500 VINSOON QUADMATIC 02-07	M763-70-10	1011-1404
LT500F QUADRUNNER 98-02	M763-70-09	1011-2543
LT500A QUADMASTER 00-01	M763-70-09	1011-2543
LT500 KINGQUAD AXI + CAGE 08-12	1011-0561	1011-0883
LT500 KINGQUAD AXI 08-12 1	1011-0562	1011-0884
LTV700 TWIN PEAK 04-06	1011-0021	1011-2536
LT700 KINGQUAD FILTER + CAGE 05-07	1011-0561	1011-0883
LT700 KINGQUAD FILTER 05-07 1	1011-0562	1011-0884
LT750 KINGQUAD FILTER + CAGE 07-12	1011-0561	1011-0883
LT750 KINGQUAD FILTER 07-12 1	1011-0562	1011-0884
YAMAHA		
YFM80-100 ALL YEARS	M763-80-10	1011-1407
YFA1 125 BREEZE 89-05	M763-80-03	1011-0871
YFM125 GRIZZLY 05-13	M763-80-03	1011-0871
YTM125/175 TRI-MOTO 82-85	M763-80-07	-
YFM200 MOTO 4 85-89	M763-80-06	1011-0874
YTM200 TRI-MOTO 83-86	M763-80-08	1011-2540
YFB250 TIMBERWOLF 92-00	M763-80-05	1011-0873
YFM250 BEAR TRACKER 00-05	M763-80-11	1011-0875
YFM250 BIG BEAR 07-09	M763-80-11	1011-0875
GRIZZLY 300 12-13	1011-2900	-
YFM350 BIG BEAR 87-99	M763-80-05	1011-0873
YFM350 BIG BEAR 00-02	M763-80-11	1011-0875
YFM350 BRUIN 04-06	1011-0022	1011-2550
YFM350 GRIZZLY 07-13	M763-80-13	1011-1408
YFM400 KODIAK 93-99	M763-80-05	1011-0873
YFM400 KODIAK 00-02	M763-80-09	1011-1406
YFM400 KODIAK 03-06	M763-80-13	1011-1408
YFM400 BIG BEAR 03-12	M763-80-11	1011-0875
YFM400 GRIZZLY 07-09	M763-80-13	1011-1408
YFM450 KODIAK 03-06	M763-80-13	1011-1408
YFM450 GRIZZLY 07-13	M763-80-13	1011-1408
RHNO 450 06-10	1011-1030	1011-1031
GRIZZLY 550 09-13	1011-1133	1011-1138
YFM600/660 GRIZZLY 98-08	M763-80-04	1011-0872
RHINO 660 04-07	1011-1030	1011-1031
GRIZZLY 700 07-13	1011-1133	1011-1138
RHINO 700 FI 08-13	1011-1377	1011-1378

¹ PAPER FILTER WITH FOAM SLEEVE



TRIPLE LAYER AIR FILTERS DRY AND PRE OILED > \$28.95-\$36.95

Unique triple stage foam filter designed for the most extreme conditions. Eliminates the need for power robbing dust covers and outerwear covers. Increased protection against silt, water, and sand. Allows for extended filter service intervals. Can be cleaned, re-oiled, and re-used like a 2 stage filter. Available in standard and pre-oiled. Used by factory off road teams around the world. Made in the USA.

FITS MODEL	DRY PART #	PRE-OILED PART #
TRIPLE LAYER AIR FILTERS		
ARCTIC CAT		
TRX250D RECON 97-13	1011-2566	1011-2599
TRX300 90-01	1011-2564	1011-2598
TRX300FW 92-01	1011-2564	1011-2598
TRX350 RANCHER ALL 00-06	1011-2562	1011-2596
RANCHER AT400 04-07	1011-2562	1011-2596
TRX400 4X4 FOREMAN 95-04	1011-2564	1011-2598
TRX450 FOREMAN ALL 98-06	1011-2562	1011-2596
TRX500 RUBICON/FOREMAN 01-13	1011-2563	1011-2597
TRX650/680 RINCON 03-13	1011-2563	1011-2597
BIG RED 700 09-13	1011-2563	1011-2597
KAWASAKI		
KVF650 PRAIRIE 03-06	1011-2573	1011-2602
KVF650 BRUTE FORCE 05-13	1011-2573	1011-2602
KVF650 I BRUTE FORCE 05-13	1011-2572	-
KFX700 V-FORCE 04-09	1011-2573	1011-2602
KVF700 PRAIRIE 04-09	1011-2573	1011-2602
KVF750 BRUTE FORCE 05-13	1011-2572	-
SUZUKI		
LTF250 OZARK 03-12	1011-2584	-
LTF250 88-02	1011-2586	1011-2610
LTF300 KINGQUAD 99-03	1011-2586	1011-2610
LT 4WDX KINGQUAD 91-03	1011-2586	1011-2610
LT 4WD QUADRUNNER 87-03	1011-2586	1011-2610
LTV700 TWIN PEAK 04-06	1011-2573	1011-2602

POLARIS		
PHOENIX 200 06-13	1011-2579	1011-2608
HAWKEYE 250 06-07	1011-2579	1011-2608
TRAILBLAZER 250 2-STR 02-08	1011-2579	1011-2608
SAWTOOTH 250 06-07	1011-2579	1011-2608
SPORTSMAN 300 08-09	1011-2579	1011-2608
TRAILBLAZER 330 08-12	1011-2579	1011-2608
MAGNUM 325-500 4-STR 02-03	1011-2579	1011-2608
MAGNUM 330 03-06	1011-2579	1011-2608
TRAILBOSS 330 08-13	1011-2579	1011-2608
TRAILBOSS 325 4-STR 01-09	1011-2579	1011-2608
MAGNUM 325 - 500 THRU 01	1011-2578	1011-2607
TRAILBOSS 325 THRU 00	1011-2578	1011-2607
XPEDITION 325 - 425 00-03	1011-2578	1011-2607
SPORTSMAN 335-500 - 6X6 96-01	1011-2578	1011-2607
SPORTSMAN 400 - 6X6 02-13	1011-2578	1011-2607
SPORTSMAN 500 4-STR 02-13	1011-2578	1011-2607
XPLORER 500 01-02	1011-2579	1011-2608
SPORTSMAN 700 02-05	1011-2578	1011-2607
700 X2 08-09	1011-2578	1011-2607
SPORTSMAN 800 06-13	1011-2578	1011-2607

YAMAHA		
YF1125 BREEZE 89-05	1011-2595	1011-2616
YFM250 BEAR TRACKER 00-05	1011-2593	1011-2614
YFM250 BIG BEAR 07-09	1011-2593	1011-2614
YFM350 BIG BEAR 00-02	1011-2593	1011-2614
YFM350 WOLVERINE 95-02	1011-2594	1011-2615
YFM400 BIG BEAR 03-12	1011-2593	1011-2614
YFM600/660 GRIZZLY 98-08	1011-2594	1011-2615

SUPER SEAL FILTER OIL > \$13.95

Performance tested for maximum airflow and protection. High-quality, water-resistant biodegradable foam filter oil. Flame resistant. Protects against dirt and the finest dust. Stays tacky, will not dry out or drip. Contained in a metal can to help keep oil as fresh as possible. Available in 1-liter cans. Made in the USA.



DESCRIPTION	PART #
SUPER SEAL FILTER OIL	3610-0007

FOAM FILTER SUPER CLEANER > \$13.95

Specially formulated for cleaning foam air filters. Biodegradable and dissolves dust and dirt. Available in 1-liter metal cans. Made in the USA.



DESCRIPTION	PART #
FOAM FILTER SUPER CLEANER	3704-0009



PULL START REBUILD KITS FOR POLARIS ATVS > \$79.95

Made to repair the pull start mechanism in Polaris ATVs. Kit includes the starter reel, return spring, ratchet, friction spring, friction plate, spring, bushing, recoil gasket and rope assembly. Imported.

FITS MODEL	PART #
PULL START REBUILD KITS	
POLARIS	
300 2X4 94	0936-0016
300 4X4 94	0936-0016
300 6X6 94	0936-0016
HAWKEYE 300 2X4 06-10	0936-0016
HAWKEYE 300 4X4 06-07	0936-0016
SPORTSMAN 300 4X4 08-10	0936-0016
TRAIL BOSS 300 2X4 95	0936-0016
TRAIL BOSS 300 4X4 95	0936-0016
XPLORER 300 4X4 96-99	0936-0016
XPRESS 300 96-99	0936-0016
MAGNUM 325 2X4 00-02	0936-0016
MAGNUM 325 4X4 00-02	0936-0016
TRAIL BOSS 325 00-02	0936-0016
XPEDITION 325 00-01	0936-0016
ATP330 4X4 04-05	0936-0016
MAGNUM 330 2X4 03-05	0936-0016

FITS MODEL	PART #
PULL START REBUILD KITS (CON'T)	
POLARIS (CON'T)	
MAGNUM 330 4X4 03-06	0936-0016
TRAIL BLAZER 330 09-10	0936-0016
TRAIL BOSS 330 03-10	0936-0016
SPORTSMAN 335 99-00	0936-0016
WORKER 335 99	0936-0016
400L 2X4 94	0936-0016
400L 4X4 94	0936-0016
400L 6X6 94	0936-0016
BIG BOSS 400L 6X6 95-97	0936-0016
SPORTSMAN 400 4X4 94-97	0936-0016
SPORTSMAN 400 4X4 01-04	0936-0016
SPORTSMAN 400 HO 4X4 08	0936-0016
TRAIL BLAZER 400 03	0936-0016
XPLORER 400 4X4 95-96	0936-0016
XPLORER 400 4X4 98-02	0936-0016
XPRESS 400L 96-97	0936-0016
MAGNUM 425 2X4 95-98	0936-0016
MAGNUM 425 4X4 95-98	0936-0016
MAGNUM 425 6X6 96-97	0936-0016
XPEDITION 425 00-02	0936-0016
SPORTSMAN 450 06-07	0936-0016
ATP500 4X4 04-05	0936-0016
BIG BOSS 500 6X6 98-99	0936-0016
MAGNUM 500 4X4 99-03	0936-0016
SPORTSMAN 500 4X4 96-00	0936-0016
SPORTSMAN 500 6X6 00-08	0936-0016
SPORTSMAN 500 HO 4X4 01-06	0936-0016
SPORTSMAN 500 HO 4X4 08	0936-0016
SPORTSMAN 500 EFI HO 4X4 06-08	0936-0016
SPORTSMAN 500 EFI X2 06-08	0936-0016
WORKER 500 99-02	0936-0016
XPLORER 500 97	0936-0016

INTAKE & EXHAUST VALVE KITS > \$179.95-\$269.95

Each kit includes stainless steel valves, high-rev valve springs, lightweight retainers, and Viton® valve seals. Stainless steel valves are made from a one-piece forging featuring 21-4N material. Valves are heat treated and feature a nitride process on the surface, which improves valve wear and overall performance. High-rev springs are coiled with a proprietary high-quality wire that undergoes a heat treating and stress relieving process, which dramatically increases the spring's life-cycle and improves valve stability at high RPMs. Valve seals are made with Viton® rubber which allows for greater seal and less stiction. Made in the USA

FITS MODEL	INTAKE KIT PART #	EXHAUST KIT PART #
INTAKE & EXHAUST VALVE KITS		
KAWASAKI		
TERYX 700 08-12	0926-2084	0926-2085
POLARIS		
RZR 800 08-12	0926-2086	0926-2087
RZR XP 900 11-13	0926-2088	0926-2089
YAMAHA		
RHINO 660 04-07	0926-2090	0926-2091
RHINO 700 08-12	0926-2092	0926-2093

PLOWS
WINCHES
UTV
RACKS
LUGGAGE
BODY
CONTROLS
ELECTRICAL
WHEELS & TIRES
SUSPENSION & DRIVE
ENGINE
NRA BY MOOSE
RIDER
TOWING
GARAGE
PROMO

HIGH PERFORMANCE 4-STROKE PISTON KITS BY CP PISTONS > \$459.95

Pistons feature x-style forgings and fully boxed-style (race pistons) forgings for ultimate strength, minimizing friction, durability, power and weight reduction. Fully-boxed style (race pistons) forgings come standard with skirt coating which reduces friction, which in return reduces heat. These are called out in the application chart. Our race piston kits include DLC pin. Internal bracing maximizes durability while decreasing friction in the pin assembly. This technology had been proven and used because of its high resistance to abrasive wear, which extends the service life and reliability under extreme conditions. Full radius dome designs maximize quench while eliminating hot spots that promote detonation. Each kit includes a piston, wrist pin, circlips and a top end gasket kit. Made in the USA.



DESCRIPTION	BORE SIZE	PART #	REPLACEMENT PARTS		
			WRIST PIN	CIRCLIPS	RING SET
PISTON KITS					
KAWASAKI					
BRUTEFORCE 750 11.0:1 05-13	85MM STD BORE	0910-1715 ¹	0913-0067 ²	0913-0076 ²	0912-0295 ²
BRUTEFORCE 750 12.0:1 05-13	85MM STD BORE	0910-2448 ¹	0913-0067 ²	0913-0076 ²	0912-0295 ²
TERYX 750 11.0:1 09-13	85MM STD BORE	0910-1715 ¹	0913-0067 ²	0913-0076 ²	0912-0295 ²
TERYX 750 12.0:1 09-13	85MM STD BORE	0910-2448 ¹	0913-0067 ²	0913-0076 ²	0912-0295 ²
POLARIS					
SPORTSMAN 800R 11.0:1 05-10	80MM STD BORE	0910-1717 ¹	0913-0088 ²	0913-0074 ²	0912-0296 ²
RZR 800 11.0:1 STD BORE 07-10	80MM STD BORE	0910-1717 ¹	0913-0088 ²	0913-0074 ²	0912-0296 ²
RZR 900XP 11.5:1 11-13	93MM STD BORE	0910-2450 ^{1,3}	0913-0156 ²	0913-0076 ²	0912-0373 ²
RZR 900XP 12.5:1 11-13	93MM STD BORE	0910-2451 ^{1,3}	0913-0156 ²	0913-0076 ²	0912-0373 ²
SUZUKI					
KING QUAD 700 11.5:1 05-07	102MM STD BORE	0910-1716	0913-0070	0913-0079	-
KING QUAD 700 11.5:1 05-07 (+2MM OVERSIZE)	104MM BORE	0910-2445	0913-0070	0913-0079	0912-0372
YAMAHA					
RHINO 660 11.0:1 02-05	100MM STD BORE	0910-1114	0913-0068	0913-0077	0912-0248
RHINO 660 11.0:1 02-05	102MM +2 OVERSIZE	0910-1115	0913-0068	0913-0077	0912-0249
RHINO 700FI 11:1 06-13	102MM STD BORE	0910-1117	0913-0070	0913-0079	0912-0251

¹ COMES WITH TWO PISTONS ² TWO REPLACEMENT PARTS NEEDED ³ GASKET SET NOT INCLUDED



HIGH PERFORMANCE CONNECTING RODS > \$249.95

Moose has teamed up with CP-Carrillo to bring you the highest quality-professional connecting rods. 100% machined and oversized forging insures proper grain flow and consistency through the manufacturing process. Made from proprietary material containing specific amounts of chrome, nickel, moly and vanadium, for ultimate strength and durability. Engineered to be lighter and stronger than stock rod. Lower reciprocating weight allows for quicker engine response. Small end bushing enables better serviceability and durability. Designed to fit OEM bearing and crank pin. For best results, use with corresponding Moose piston kit. Made in the USA.

DESCRIPTION	PART #
HIGH PERFORMANCE CONNECTING RODS	
YAMAHA	
YFM660 GRIZZLY 02-05	0923-0298
RHINO 660 04-07	0923-0298
GRIZZLY 700 06-13	0923-0300
RHINO 700 08-10	0923-0300



EXHAUST TIPS > \$39.95-\$57.95

Improve discolored OEM exhaust without spending a fortune. Made from CNC-billet aluminum. 15° angled exhaust port and machined gun barrel divots on the tip. Angle directs exhaust flow down and away from fenders and tailgates. Can be used with or without stock spark arrestor. Made in the USA.

DESCRIPTION	PART #
EXHAUST TIPS	
HONDA	
TRX500 FOREMAN 05-08	1861-0482
TRX500 RUBICON 01-08	1861-0482
KAWASAKI	
TERYX 750 08-12	1861-0481
YAMAHA	
YFM350 BRUIN 04-09	1861-0374
GRIZZLY 350 07-12	1861-0374
GRIZZLY 400/450 07-08	1861-0374
KODIAK 400/450 03-09	1861-0374
RHINO 450 04-09	1861-0374
GRIZZLY 550 09-12	1861-0483
GRIZZLY 660 02-08	1861-0374
RHINO 660 04-07	1861-0374
GRIZZLY 700 07-12	1861-0483
RHINO 700 08-12	1861-0485



REPLACEMENT CYLINDERS > \$199.95-\$349.95

Replace your damaged or worn OEM cylinder. Made from cast aluminum, nickel silicon carbide plated. Precision machined and honed to OEM stock bore sizes. Extremely durable low friction bore surface allows for greater heat dissipation. Stock OEM appearance. Made in the USA.

DESCRIPTION	PART #
REPLACEMENT CYLINDERS	
YAMAHA	
GRIZZLY 700 07-13	0931-0455
RHINO 700 08-13	0931-0455



- PROMO
- GARAGE
- TOWING
- RIDER
- NRA BY MOOSE
- ENGINE**
- SUSPENSION & DRIVE
- WHEELS & TIRES
- ELECTRICAL
- CONTROLS
- BODY
- LUGGAGE
- RACKS
- UTV
- WINCHES
- PLOWS



1901-0335



1901-0336



1901-0337



1901-0340



1901-0338

OEM REPLACEMENT COOLING FANS > \$112.95-\$208.95

Easily installs using original mounting hardware. All fans are waterproof and dustproof. All fans (except Polaris fans) are typically 25% higher CFM than the stock fan. The Polaris fans are OEM compatible in design and output. Less expensive than factory replacements with more performance. Imported.

FITS MODEL	PART #
OEM REPLACEMENT COOLING FANS	
ARCTIC CAT	
375 02	1901-0340
400 02-07	1901-0340
500 02-09	1901-0340
550 TRV 09	1901-0340
650 4X4 04-10	1901-0340
700 06-10	1901-0340
PROWLER 1000 09	1901-0340
PROWLER 550 09	1901-0340
PROWLER 650 06-09	1901-0340
PROWLER 700 08-09	1901-0340
THUNDERCAT 4X4 08-10	1901-0340
1000 TRV 09-10	1901-0340
CAN-AM	
OUTLANDER 400 08	1901-0336
OUTLANDER 500 07-08	1901-0336
OUTLANDER 650 06-08	1901-0336
OUTLANDER 800 06-08	1901-0336
RENEGADE 500 08	1901-0336
RENEGADE 800 07-08	1901-0336
POLARIS	
SPORTSMAN 400 04 MODEL CODE-A04CH42AA/AE/AG, 9"	1901-0336
SPORTSMAN 500 04 MODEL CODE-A04CH50AA/AC/AE/AG, 9"	1901-0336
SPORTSMAN 500 04 MODEL CODE-A04CH50AA/AQ/AR/AS/AT/AV/AW/AX, 11"	1901-0334
SPORTSMAN 400 04 MODEL CODE A04CH42AQ/AR/AS/AT/AV, 11"	1901-0334
ATP 330 4X4 04	1901-0339
ATP 500 4X4 04-05	1901-0336
ATV PRO 500 4X4 PPS 02	1901-0336
BIG BOSS 6X6 00-02	1901-0336
DIESEL 00-01	1901-0336
LUH 6X6 PPS 02	1901-0336
MAGNUM 325 2X4 00-02	1901-0339
MAGNUM 325 4X4 00-02	1901-0339
MAGNUM 330 2X4 03-04	1901-0339
MAGNUM 330 4X4 03-04	1901-0339
MAGNUM 500 00-03	1901-0336
PTV 4X4 SERIES 10 03	1901-0336
PTV 6X6 SERIES 10 03	1901-0336
RANGER 2X4 & 4X4 04-05	1901-0335
RANGER 500 2X4 06-09	1901-0335
RANGER 500 4X4 06-09	1901-0335
RANGER 6X6 04-05	1901-0335
RANGER 700 4X4 07-09	1901-0338
RANGER 700 4X4 CREW 08-09	1901-0338
RANGER 700 6X6 06-09	1901-0338
RANGER XP 05	1901-0338
RANGER XP 700 4X4 06	1901-0338

FITS MODEL	PART #
OEM REPLACEMENT COOLING FANS (CON'T)	
POLARIS (CON'T)	
SPORTSMAN 335 99-00	1901-0339
SPORTSMAN 335 00	1901-0339
SPORTSMAN 400 01-03	1901-0336
SPORTSMAN 400 05	1901-0334
SPORTSMAN 450 06-07	1901-0334
SPORTSMAN 500 00-03	1901-0336
SPORTSMAN 500 05-10	1901-0334
SPORTSMAN 600 03-05	1901-0337
SPORTSMAN 6X6 00-03	1901-0336
SPORTSMAN 700 02-06	1901-0337
SPORTSMAN 800 05-06	1901-0338
SPORTSMAN 800 08-10	1901-0337
SPORTSMAN 800 EFI 6X6 09-10	1901-0337
SPORTSMAN MV7 05	1901-0337
SPORTSMAN TOURING 500 EFI 08-09	1901-0334
SPORTSMAN X2 500 06-09	1901-0334
TRAIL BLAZER 400 03	1901-0336
TRAIL BOSS 00-02	1901-0339
TRAIL BOSS 325 01	1901-0339
TRAIL BOSS 330 03-04	1901-0339
WORKER 335 99	1901-0339
WORKER 500 01	1901-0336
XPEDITION 325 01-02	1901-0339
XPEDITION 425 00-02	1901-0336
XPLORER 400 01-02	1901-0336
SPORTSMAN 400 HO 4X4 11	1901-0334
SPORTSMAN 500 11	1901-0334
SPORTSMAN XP 850 09	1901-0350
SPORTSMAN XP EPS 850 09	1901-0350
SPORTSMAN XP 850 10	1901-0350
SPORTSMAN XP EPS 850 10	1901-0350
RZR XP 900 11	1901-0350
SPORTSMAN TOURING 800 09 IF BUILT 02/03/09 TO 04/06/2009	1901-0337
SPORTSMAN X2 800 09 IF BUILT 02/03/09 TO 04/06/2009	1901-0337
SPORTSMAN 700 07 IF BUILT AFTER 10/05/06	1901-0337
SPORTSMAN 800 07 IF BUILT AFTER 10/05/06	1901-0337
SPORTSMAN 700 07 IF BUILT BEFORE 10/05/06	1901-0338
SPORTSMAN 800 07 IF BUILT BEFORE 10/05/06	1901-0338
RANGER 800 4X4 10	1901-0337
RANGER 800 4X4 CREW 10	1901-0337
RANGER 800 6X6 10	1901-0337
YAMAHA	
BIG BEAR 400 2WD 00-04	1901-0333
BIG BEAR 400 4WD 00-06	1901-0333
GRIZZLY 600 98-01 (REPL. OIL COOLER FAN)	1901-0320
KODIAK 400 4WD 96-98 (REPL. OIL COOLER FAN)	1901-0320



1901-0318



1901-0325



1901-0321



1901-0329

HI-PERFORMANCE COOLING FANS > \$150.95-\$274.95

Easily installs using original mounting hardware. Typically higher CFM than stock. Sealed waterproof and dustproof motors. 6,000 hour brush life. CFM = cubic feet per minute; it's a rating used to tell how much airflow a fan has. Imported.

FITS MODEL	DESCRIPTION	PART #
HI-PERFORMANCE COOLING FANS		
KAWASAKI		
KVF400 PRAIRIE 97-02	330 CFM	1901-0332
KLF400 BAYOU 93-99	440 CFM	1901-0328
KVF650 BRUTE FORCE 05-09	440 CFM	1901-0330
KVF700 PRAIRIE 04-06	440 CFM	1901-0330
KVF750 BRUTE FORCE 05-11	440 CFM	1901-0329
TERYX 750 08-09	600 CFM	1901-0331
MULE 3000, 3010, 3020 4X4 GAS AND DIESEL	600 CFM	1901-0322
POLARIS		
350L 2X4, 4X4, 6X6 93	440 CFM	1901-0325
400L 2X4 94-95	440 CFM	1901-0325
400L 4X4 94	440 CFM	1901-0325
400L 6X6 94	440 CFM	1901-0325
400L 6X6 96	440 CFM	1901-0325
BIG BOSS 500 6X6 98-99	440 CFM	1901-0325
BIG BOSS 6X6 400L 95	440 CFM	1901-0325
BIG BOSS 6X6 400L 97	440 CFM	1901-0325
DIESEL 99	440 CFM	1901-0325
MAGNUM 425 2X4 95-98	440 CFM	1901-0325
MAGNUM 425 4X4 95-98	440 CFM	1901-0325
MAGNUM 500 99	440 CFM	1901-0325
MAGNUM 500 6X6 96-97	440 CFM	1901-0325
SPORTSMAN 400L 97	440 CFM	1901-0325
SPORTSMAN 500 4X4 93-96	440 CFM	1901-0325
SPORTSMAN 500 96-99	440 CFM	1901-0325
TRAIL BLAZER 250 96-97	440 CFM	1901-0325
TRAIL BOSS 350L 90-92	440 CFM	1901-0325
WORKER 500 99	440 CFM	1901-0325
XPLORER 500 95	440 CFM	1901-0325
XPLORER 500 00-01	440 CFM	1901-0325
XPLORER 400 99-00	440 CFM	1901-0325
XPLORER 400L 96-98	440 CFM	1901-0325
XPLORER 400 4X4 02	440 CFM	1901-0325
XPLORER 500 97	440 CFM	1901-0325
XPRESS 300 96	440 CFM	1901-0325
XPRESS 400 96-97	440 CFM	1901-0325
RANGER 800 4X4 11	1340 CFM	1901-0413
RANGER 800 XP 12	1340 CFM	1901-0413

FITS MODEL	DESCRIPTION	PART #
HI-PERFORMANCE COOLING FANS (CON'T)		
POLARIS (CON'T)		
RANGER 800 4X4 DIESEL CREW 12	1340 CFM	1901-0413
RANGER 800 6X6 12	1340 CFM	1901-0413
RANGER 800 EPS 12	1340 CFM	1901-0413
RANGER 800 CREW 12	1340 CFM	1901-0413
RANGER 6X6 12	1340 CFM	1901-0413
RZR 800 08-10	100 CFM MORE THAN STOCK FAN	1901-0337
RZR S 800 09-10	100 CFM MORE THAN STOCK FAN	1901-0337
RZR 800 08-10	200 CFM MORE THAN STOCK FAN	1901-0338
RZR S 800 09-10	200 CFM MORE THAN STOCK FAN	1901-0338
SUZUKI		
LT-A450X 07-09	440 CFM	1901-0351
LT-A450XZ 08-09	440 CFM	1901-0351
LT-A500XP 09	440 CFM	1901-0351
LT-A500XPZ 09	440 CFM	1901-0351
LT-A700X 06-07	440 CFM	1901-0351
LT-A750X 08-09	440 CFM	1901-0351
LT-A750XP 09	440 CFM	1901-0351
LT-A750XPZ 09	440 CFM	1901-0351
LT-A750XZ 08-09	440 CFM	1901-0351
LT-V700F TWIN PEAKS 04-05	440 CFM	1901-0330
YAMAHA		
GRIZZLY 400 07-08	440 CFM	1901-0319
GRIZZLY 450 07-09	440 CFM	1901-0319
GRIZZLY 550 09	440 CFM	1901-0318
GRIZZLY 660 02-08	440 CFM	1901-0316
GRIZZLY 700 07-10	440 CFM	1901-0318
KODIAK 400 2WD 00-01	440 CFM	1901-0315
KODIAK 400 2WD 04	440 CFM	1901-0319
KODIAK 400 4WD 00-02	440 CFM	1901-0315
KODIAK 400 4WD 03-06	440 CFM	1901-0319
KODIAK 450 4WD 03-06	440 CFM	1901-0319
RHINO 450 04-09	700 CFM / DUAL FANS	1901-0311
RHINO 660 04-07	700 CFM / DUAL FANS	1901-0311
RHINO 700 08-09	800 CFM	1901-0321
RHINO 450 04-09	800 CFM / SINGLE FAN	1901-0312
RHINO 660 04-07	800 CFM / SINGLE FAN	1901-0312

PROTECT AND PRESERVE

Purchasing an industry-leading product not only protects your machine, it also preserves your rights. When you buy an NRA by Moose product, a percentage of the sale goes directly back to the NRA and back to preserving our 2nd Amendment heritage. We can all take pride in that.





Officially Licensed **By** **MOOSE** UTILITY DIVISION

PLOWS

WINCHES

UTV

RACKS

LUGGAGE

BODY

CONTROLS

ELECTRICAL

WHEELS & TIRES

SUSPENSION & DRIVE

ENGINE

NRA BY MOOSE

RIDER

TOWING

GARAGE

PROMO



TRADITION - BLACK



TRADITION - MOSSY OAK BREAK-UP®



TRADITION - REALTREE AP™



TRADITION REAR RACK BAG >\$109.95-\$119.95

This quality cargo system is manufactured with durable 600 denier nylon and is sure to be as strong as the tradition of the NRA itself. Riveted straps and carrying handles add true functionality. Two rugged, external compartments with adjustable weather flaps, elastic tool loops, key hooks, mesh storage pockets along with internal mesh pockets. High-density foam seat pad is integrated into the bag and provides a place to rest when your ATV is parked. Do not use as seat while riding. Insulated storage bag doubles as a cooler with external shotgun shell holders on the back providing quick access to more than 15 shells; also serves as a handy tool holder. Water-resistant fabric resists the elements and cleans up easily with a damp cloth. All mounting straps and detailed instructions included. Overall dimensions 37" W x 12" H x 21.5" L. Contents not included. Imported.

DESCRIPTION	PART #
BLACK	3505-0138
MOSSY OAK BREAK-UP®	3505-0139
REALTREE AP™	3505-0150

MULTIPLE COMPARTMENTS



CALIBER - BLACK



CALIBER - MOSSY OAK BREAK-UP®



REMOVABLE TOP BAGS



CALIBER REAR RACK BAG > \$136.95-\$144.95

600 denier water-resistant nylon bag has many of the same features as the Legacy Rear Rack Bag, but in a more compact design. Premium cargo system with riveted straps and carrying handles add true functionality to your ATV. High-density foam seat pad integrated into bag provides a comfortable place to rest while your ATV is parked. Do not use as seat while riding. Large storage compartment has movable internal storage dividers, key clip and two zippered mesh pockets. Four external storage compartments, including two removable top bags provide quick access to all your gear. Two external and two internal mesh pockets permit easy access to your favorite items. External loop system allows you to easily strap on additional items like a bow, gun or a variety of tools. External fabric resists the elements and cleans up easily with a damp cloth. All mounting straps and detailed instructions included. Overall dimensions 37" W x 12" H x 21" L. Contents not included. Imported.

Pursuit rifle case sold separately; see page 193 for information

DESCRIPTION	PART #
BLACK	3505-0136
MOSSY OAK BREAK-UP®	3505-0137



PLOWS
WINCHES
UTV
RACKS
LUGGAGE
BODY
CONTROLS
ELECTRICAL
WHEELS & TIRES
SUSPENSION & DRIVE
ENGINE
NRA BY MOOSE
RIDER
TOWING
GARAGE
PROMO



LEGACY REAR - BLACK



LEGACY REAR - MOSSY OAK BREAK-UP®



REMOVABLE COOLER



LEGACY REAR RACK BAG > \$157.95-\$168.95

600 denier nylon is used to construct a rigid bag that includes riveted straps and carrying handles for true functionality. Large storage compartment features a removable cooler for keeping items cold, or hot, moveable storage dividers, key clip and two zippered mesh pockets. Two removable top bags include elastic tool loops, key book and mesh storage pockets. Two smaller outside pockets provide quick access to your gear and feature internal mesh storage pockets (one with security zipper). Outside of the bag has two additional mesh storage pockets for trailside essentials. External loop system (straps provided) allows you to easily fasten additional cargo to the bag. Water-resistant fabric resists the elements and cleans up easily with a damp cloth. All mounting straps and detailed instructions included. Overall dimensions 34" W x 12" H x 20" L. Contents not included. Imported.

Pursuit rifle case sold separately; see page 193 for information

DESCRIPTION	PART #
BLACK	3505-0134
MOSSY OAK BREAK-UP®	3505-0135



LEGACY - BLACK



LEGACY - MOSSY OAK BREAK-UP®



LARGE STORAGE COMPARTMENT



LEGACY RACK BAG >\$152.95-\$162.95

This premium cargo system is sure to create its own legacy in the world of ATV luggage. Riveted straps and carrying handles adds true functionality to your ATV. Large, center storage compartment provides ample space and includes two, zippered mesh storage pockets and key clip. Carry valuables anywhere with removable top bag. Two additional storage compartments feature four additional mesh pockets, including two zippered security versions. Four front, outside pockets offer a variety of features including elastic tool holders, mesh pockets and quarter hasps that accept padlocks to secure your most valuable items. External loop system (straps provided) allows you to easily strap on additional cargo. Rugged, water-resistant 600 denier nylon stands up to the toughest elements and cleans up easily with a damp cloth. All mounting straps and detailed instructions included. Overall dimensions 33" W x 16" H x 15" L. Contents not included. Imported.

DESCRIPTION	PART #
BLACK	3505-0142
MOSSY OAK BREAK-UP®	3505-0143

Pursuit rifle case sold separately; see page 193 for information



PLOWS
WINCHES
UTV
RACKS
LUGGAGE
BODY
CONTROLS
ELECTRICAL
WHEELS & TIRES
SUSPENSION & DRIVE
ENGINE
NRA BY MOOSE
RIDER
TOWING
GARAGE
PROMO

HERITAGE - BLACK



HERITAGE - MOSSY OAK BREAK-UP®



REMOVABLE COOLER



HERITAGE RACK BAG > \$92.95-\$104.95

This entry level rack bag is high on features, yet low on price. Riveted straps and carrying handles adds true functionality to your ATV. Storage compartment features a removable cooler for keeping items cold, or hot. Exterior of bag features one oversized, zippered compartment with adjustable flap, two additional outside pockets, key hook and mesh storage pouch. Internally you will find two mesh storage pockets, one with a security zipper, that provide additional storage space. Manufactured from water-resistant 600 denier nylon to keep Mother Nature out and cleans up easily with a damp cloth. All mounting straps and detailed instructions included. Overall dimensions 36" W x 13" H x 13" L. Contents not included. Imported.

Pursuit rifle case sold separately; see page 193 for information

DESCRIPTION	PART #
BLACK	3505-0140
MOSSY OAK BREAK-UP®	3505-0141





BLACK



MOSSY OAK BREAK-UP®

PURSUIT RIFLE CASE > \$39.95-\$47.95

Universal gun sheath and storage system (with carrying handle) is constructed from tough 600 denier nylon and was created to provide superior protection for the finest firearms. Fits nicely on NRA or Moose Utility Division luggage systems. Large, padded storage system resists moisture and features an internal shell holder and storage compartment. Weather-resistant exterior resists the elements and cleans up easily with a damp cloth. Overall dimensions 50" L x 9.5" H. Imported.

DESCRIPTION	PART#
BLACK	3518-0049
MOSSY OAK BREAK-UP®	3518-0050



The Pursuit rifle case can also attach to the back of the following rack bags: Legacy Rear Rack Bag, Caliber Rear Rack Bag, Legacy Rack Bag & Heritage Rack Bag



- PLOWS
- WINCHES
- UTV
- RACKS
- LUGGAGE
- BODY
- CONTROLS
- ELECTRICAL
- WHEELS & TIRES
- SUSPENSION & DRIVE
- ENGINE
- NRA BY MOOSE**
- RIDER
- TOWING
- GARAGE
- PROMO



LEGACY - MOSSY OAK BREAK-UP®



LEGACY - BLACK

TWO, LARGE ZIPPERED STORAGE COMPARTMENTS

LEGACY FENDER BAG > \$33.95-\$38.95

Form-fitted bag mounts easily to your ATV's rack and fenders, with or without rack bags. Includes riveted straps and carrying handle. Two, large zippered storage compartments include an internal key clip and two mesh storage pockets (one with a security zipper). Quarter-turn hasps accept mini padlocks for security. External, elastic mesh storage pockets provide additional storage space. Water-resistant exterior of 600 denier nylon resists the elements and cleans up easily with a damp cloth. All mounting straps and detailed instructions included. Overall dimensions 9" W x 10" H x 18" L. Contents not included. Imported.

DESCRIPTION	PART #
BLACK	3509-0013
MOSSY OAK BREAK-UP®	3509-0014



QUARTER-TURN HASPS ACCEPT MINI PADLOCKS

QUICK-RELEASE SIDE STORAGE COMPARTMENTS



LEGACY - BLACK



LEGACY - MOSSY OAK BREAK-UP®

LEGACY TANK BAG > \$31.95-\$36.95

Quality 600 denier water-resistant nylon is used to create a unique throw-over bag system featuring riveted straps and carrying handles. Non-slip yoke with hook and loop fasteners installs quickly on all ATVs, with or without a central top gas cap. Quick-release side storage compartments provide ample room and two internal storage dividers keep your belongings organized. Outside of bag has an elastic mesh storage pocket for easy access to your favorite items. Quarter-turn hasps accept mini padlocks for security. Rugged exterior fabric cleans up easily with a damp cloth. All hardware and mounting instructions included. Overall dimensions 12" W x 4.5" H x 11.5" L. Contents not included. Imported.

DESCRIPTION	PART #
BLACK	3502-0171
MOSSY OAK BREAK-UP®	3502-0172



CUSTOM ZIPPER PULLS



LEGACY SINGLE GUN RACK > \$31.95

Rubber coated gun rack attaches to handlebars as well as rails (tubular or square) or metal racks. The offset design allows more room for cargo rack space. Soft rubber spurs help to hold items secure. Racks can be aligned at an angle for smaller items. Includes rubber snubbers for added security in rough terrain. One piece design guarantees no parts to lose. Gun not included. Imported.

DESCRIPTION	PART #
LEGACY SINGLE GUN RACK	3518-0044



HERITAGE SINGLE GUN RACK > \$38.95

Rubber coated gun rack attaches to handlebars as well as rails (tubular or square) or metal racks. Using the master block mount and the pack-rack plus fork, makes this rack extremely versatile. Includes rubber snubbers for added security in rough terrain. Gun not included. Imported.

DESCRIPTION	PART #
HERITAGE SINGLE GUN RACK	3518-0025



CALIBER SINGLE GUN RACK > \$35.95

Soft rubber fins and extra rubber in the bottom to hold gun securely. Patented design uses alternating long and short fins that don't bind up and help cushion the gun. Aluminum mounting blocks attach to the handlebars or ATV cargo rack rails. Twist the fork and lock the wing nut for a tighter fit. Includes rubbers snubbers. Gun not included. Imported.

DESCRIPTION	PART #
CALIBER SINGLE GUN RACK	3518-0028



TRADITION DOUBLE GUN RACK > \$44.95

Rubber coated gun rack attaches to rails (tubular or square) or metal racks. Nylon base design allows rack to custom fit different diameter items by turning rack and tightening u-bolts. Includes rubber snubbers for added security in rough terrain. Soft rubber spurs help to hold items secure. Great for carrying two guns. Guns not included. Imported.

DESCRIPTION	PART #
TRADITION DOUBLE GUN RACK	3518-0045



PURSUIT DOUBLE GUN RACK > \$63.95

Rubber coated gun rack attaches to rails (tubular or square) or metal racks. Uses a master block and a larger plus fork for extreme versatility. Includes rubber snubbers for added security in rough terrain. Soft rubber spurs help to hold items secure. Great for carrying two guns. Guns not included. Imported.

DESCRIPTION	PART #
PURSUIT DOUBLE GUN RACK	3518-0043



ATV GUN RACK > \$67.95

One mounting block allows you to put this rack anywhere on your ATV's rack or rail. Gun holders can slide to the correct width for a custom fit. Compression rubber honeycomb keeps your gear held tight. Comes with rubber snubbers for use in rough terrain. Gun not included. Imported.

DESCRIPTION	PART #
ATV DOUBLE GUN RACK	3518-0023



QUICK DRAW UTV GUN CARRIER > \$85.95-\$124.95

The Quick-Draw holds two guns (shotgun, rifle or muzzleloader) securely and protected in a soft, cushioned cradle. Unlike conventional clips and loops, our unique book and loop pull-tabs form and fit the holding cradles to the exact size of the stock or forearm of the gun it is holding - no more loose fits to disturb the sight and scope settings! Constructed of aircraft aluminum and finished off with super tough powder coat paint for years of good looks and dependable service. Comes with all necessary hardware for quick and easy installation. Will not work on Yamaba Rhino. Not intended for carrying loaded guns. Guns not included. Made in the USA.

DESCRIPTION	PART #
QUICK DRAW UTV GUN CARRIER	3518-0052
POLARIS RANGER 800 FULL-SIZE ADAPTER PLATE	3518-0053
POLARIS RANGER 400/500 MID-SIZE ADAPTER PLATE	3518-0068



QUICK DRAW UTV OVERHEAD GUN CARRIER > \$109.95-\$112.95

Holds two guns securely in the inside roof area of the UTV. Unique mounting system installs in just minutes without drilling or bolting. Features super-soft rubber gun clips that provide easy access and secure transport. Fits UTVs with upper roof frames that measure 23 to 28 inches from front to back.. Guns not included. Made in the USA.

FITS MODEL	PART#	FITS MODEL	PART#
HONDA		KUBOTA	
BIG RED (ALL YEARS)	3518-0060	RTV 500 (ALL YEARS)	3518-0060
KAWASAKI		POLARIS	
MULE 610 (ALL YEARS)	3518-0060	RANGER 500 (ALL YEARS)	3518-0060
MULE 4010 (ALL YEARS)	3518-0060	RANGER 800 (ALL YEARS)	3518-0060
TERYX 750 (ALL YEARS)	3518-0065	YAMAHA	
		RHINO (ALL YEARS)	3518-0065



UTV GUN RACK > \$69.95

One mounting block allows you to put this rack anywhere on your UTV's rack or rail. Gun holders can slide to the correct width for a custom fit. Fits straight or angled UTV bars. Compression rubber honeycomb keeps your gear held tight. Comes with rubber snubbers for use in rough terrain. Gun not included. Imported.

DESCRIPTION	PART #
UTV GUN RACK	3518-0024



BLACK



MOSSY OAK BREAK-UP®



SPECIALTY GUN CASE > \$75.95-\$79.95

Universal gun sheath and storage system with riveted carrying handle. The finest 600 denier nylon keeps the elements at bay and includes an external shell holder (holds more than 20 shells) and handy tool holder to put your most important items at your fingertips. Exterior also features three, foam-lined pockets with weather-resistant flaps. Interior is a large, padded storage sleeve that resists moisture. Universal mounting system includes and detailed instruction set with six sturdy D-rings that facilitate easy attachment of other NRA or Moose Utility Division luggage systems. Overall dimensions 11" W x 55" L. Contents not included. Imported.

DESCRIPTION	PART #
BLACK	3518-0047
MOSSY OAK BREAK-UP®	3518-0048

D-RINGS FACILITATE EASY ATTACHMENT OF OTHER NRA OR MOOSE UTILITY DIVISION LUGGAGE SYSTEMS (OTHER LUGGAGE NOT INCLUDED)



BACK REST > \$89.95

Patented rubber ball and socket system allows adjustment of the back rest up, down, forward or back. The double stainless steel U-bolt mounting base is designed to accommodate rails from 0.5" to 1.25" in diameter. The double socket arm length is 4.68". Made in the USA.

DESCRIPTION	PART #
BACK REST	3550-0123



TRACKER FRONT STORAGE TRUNK > \$129.95

Fits all ATVs with metal racks and includes u-bolts for mounting. Made from easy to clean, high impact resistant polyethylene. Large access door for storage. UV stabilized. Measures 32"L x 18"W x 9.5"H. Imported.

DESCRIPTION	PART #
TRACKER STORAGE TRUNK	3505-0133

BLACK



MOSSY OAK BREAK-UP®



REALTREE AP™



BUILT-IN POCKETS FOR HAND WARMER PACKETS



PURSUIT HANDWARMERS > \$28.95-\$31.95

Rugged 600 denier nylon creates the ultimate, water-resistant handwarmer. Premium system features built-in pockets for warmer packets (not included). Easily cleans up with a damp cloth. Overall dimensions 16" W x 14" L. Imported.

DESCRIPTION	PART #
BLACK	0635-0813
MOSSY OAK BREAK-UP®	0635-0814
REALTREE AP™	0635-0872



HEATED GRIPS > \$59.95

40 watts of heating power. Increased rider comfort with even and consistent heat distribution from unique flex circuit technology. Fits all 7/8" handlebars with no adhesive required. Great feel and handling from the special molded rubber grips. Made in the USA.

DESCRIPTION	PART #
HEATED GRIPS	0631-0017
REPL. SWITCH	0631-0009
REPL. GRIP	0631-0019



TREE STAND CARRIER > \$44.95

Mounts to the rack in minutes and holds your stand firmly in place with a tension system. Coated arms grip and protect your stand. Carrier includes a drilled hole for an additional bungee strap that allows extra support. Fits all ATV's with metal racks. Treestand not included. Made in the USA.

DESCRIPTION	PART #
TREE STAND CARRIER	1512-0048

PLOWS

WINCHES

UTV

RACKS

LUGGAGE

BODY

CONTROLS

ELECTRICAL

WHEELS & TIRES

SUSPENSION & DRIVE

ENGINE

NRA BY MOOSE

RIDER

TOWING

GARAGE

PROMO



UTV ELECTRONICS HOLDER > \$34.95

Designed to carry devices such as cell phones, GPS units, i-Pods and hand-held radios. Puts the devices within easy reach of the UTV operator. Mounting block attaches to bars up to 1 3/4" in diameter. Grip knob provides quick attachment and removal. Dimensions: 4 1/2" H x 3 1/4" W. Inside pocket dimensions: 2 3/4" W x 1 1/2" D. Imported.

DESCRIPTION	PART #
UTV ELECTRONICS HOLDER	4402-0073

ATV & UTV DRINK HOLDERS > \$29.95-\$31.95

Simple and convenient. For standard water bottles and 20oz plastic soda bottles. ATV drink holder can mount almost anywhere on the ATV. UTV drink holder comes with heavy-duty u-bolts that can attach to bars up to 1 3/4" in diameter. Water bottles not included. Imported.

DESCRIPTION	PART #
ATV DRINK HOLDER	3550-0112
UTV DRINK HOLDER	3550-0113

WINDSHIELDS > \$99.95

Made from .100" polycarbonate material. Rigid, four point mounting hardware with breakaway design. Quick disconnect handlebar clamps for easy removal. Measures 19" H x 37.5" L. Made in the USA.

DESCRIPTION	PART #
ATV'S WITH HEADLIGHT CUTOUT	2317-0082
ATV'S WITH NO HEADLIGHT CUTOUT	2317-0083
HONDA FOREMAN'S VERSION	2317-0084
HONDA RINCON VERSION	2317-0085





PLOWS

WINCHES

UTV

RACKS

LUGGAGE

BODY

CONTROLS

ELECTRICAL

WHEELS & TIRES

SUSPENSION & DRIVE

ENGINE

**NRA
BY MOOSE**

RIDER

TOWING

GARAGE

PROMO



PURSUIT ATV COVER > \$65.95-\$89.95

Made from, 210-denier Urethane coated nylon. Will not fade, shrink, stretch or mildew. Double stitched hems with heavy-duty elastic shock cord at the hem. Tie-down loops sewn into the hem. Includes a convenient storage bag. Imported.

DESCRIPTION	PART #
L COVER	4002-0045
XL COVER	4002-0046
XXL COVER	4002-0047



PURSUIT UTV COVER > \$97.95

Made from urethane coated black nylon. Super strong and water resistant. Made to fit all utility vehicle types. Measures 120" L x 65" W x 76" H. Includes a convenient storage bag. Imported.

DESCRIPTION	PART #
PURSUIT UTV COVER	4002-0048

COVER SIZING CHART

L SIZES			
OVERALL LENGTH: 75"	FRONT WIDTH: 52"	CENTER WIDTH: 33"	
REAR WIDTH: 48"	FRONT HEIGHT: 27"	CENTER HEIGHT: 40"	REAR HEIGHT: 34"
XL SIZES			
OVERALL LENGTH: 90"	FRONT WIDTH: 52"	CENTER WIDTH: 33"	
REAR WIDTH: 48"	FRONT HEIGHT: 27"	CENTER HEIGHT: 40"	REAR HEIGHT: 34"
XXL SIZES			
OVERALL LENGTH: 112"	FRONT WIDTH: 52"	CENTER WIDTH: 36"	
REAR WIDTH: 53"	FRONT HEIGHT: 44"	CENTER HEIGHT: 52"	REAR HEIGHT: 52"



3500 LB. WINCH > \$528.95

With a 3500 lb capacity, this winch is perfect for larger ATVs and UTVs. All-metal gear housing and a powerful permanent magnet motor. Comes with 50' of 3/16" wire rope and plow roller fairlead. Hook, tie rods, and body feature attractive, corrosion-resistant black finish. Corded remote and mini-rocker control switch with integrated socket. Three-stage planetary gear train for smooth, efficient operation. Ergonomic clutch handle. Patented roller disc brake for outstanding control while winching. Fully sealed motor and drive train to keep the elements out. Made in the USA.

DESCRIPTION	PART#
3500 LB WINCH	4505-0477

TIE DOWNS > \$20.95-\$29.95

Burly, 1 1/2" nylon strap provides ultimate strength and security. Oversized, high-strength rubber coated hooks. Available with standard or ratchet buckles. Standard weight capacity 1,850 lbs. Ratchet weight capacity 2,000 lbs. Sold in pairs; available in black only. Made in the USA.



STANDARD STYLE

RATCHET STYLE

DESCRIPTION	PART#
RATCHET TIE DOWN	3920-0311
STANDARD TIE DOWN	3920-0310



BI-FOLD ALUMINUM RAMP > \$202.95

Durable and lightweight ramp is weather resistant and comes with a sturdy aluminum frame. Comes with E-Z grip rubber truck rests and nylon safety straps. Open ramp size is 46" W x 71" L. Folded ramp size is 23" W x 71" L x 4.5". Weight capacity is 1,250 lbs. Warning: Do not ride on ramps at anytime. Made in the USA.

DESCRIPTION	PART#
BI-FOLD ALUMINUM RAMP	3910-0026



TRI-FOLD ALUMINUM RAMP > \$306.95

Durable and lightweight ramp is weather resistant and comes with a sturdy aluminum frame. Comes with E-Z grip rubber truck rests and nylon safety straps. Open ramp size is 46" W x 82" L. Folded ramp size is 15" W x 82" L x 6.75". Weight capacity is 1,250 lbs. Warning: Do not ride on ramps at anytime. Made in the USA.

DESCRIPTION	PART#
TRI-FOLD ALUMINUM RAMP	3910-0027

- PLOWS
- WINCHES
- UTV
- RACKS
- LUGGAGE
- BODY
- CONTROLS
- ELECTRICAL
- WHEELS & TIRES
- SUSPENSION & DRIVE
- ENGINE
- NRA BY MOOSE
- RIDER
- TOWING
- GARAGE
- PROMO





PROMO	GARAGE	TOWING	RIDER	NRA BY MOOSE	ENGINE	SUSPENSION & DRIVE	WHEELS & TIRES	ELECTRICAL	CONTROLS	BODY	LUGGAGE	RACKS	UTV	WINCHES	PLOWS
-------	--------	--------	--------------	--------------	--------	--------------------	----------------	------------	----------	------	---------	-------	-----	---------	-------



BOOT, HELMET & GLOVE DRYER > \$119.95

PEET® multi dryer provides convection air technology that circulates air to safely dry footwear, gloves and helmets. Eliminates odor caused by perspiration and bacteria. Removes mold and mildew that deteriorates linings. Two dryports for gloves, one dryport for helmet and four footwear dryports included. Does not get hot or blow hot air. Dryports must be used for drying all gear. 110 volt. Gloves, boots and helmet not included. Imported.

DESCRIPTION	PART #
BOOT, HELMET & GLOVE DRYER	3430-0195



ATV SOLE

M1.2 BOOT W/ ATV SOLE > \$144.95

Genuine split grain leather chassis with polyurethane coating for long lasting durability. Contoured thermoplastic polyurethane shin, ankle, and a low profile toe plate for abrasion resistance. Heavyweight suede leather inner calf guard for abrasion and heat resistance. Thermoplastic polyurethane buckle with steel hinge provides durability and smooth action. Adjustable and replaceable thermoplastic polyurethane closure strap for ultimate fit. Rigid steel shank reinforced sole eliminates sole flex and provides superior foot protection. Multi-layer synthetic rubber outsole provides superior grip. Polyester and EVA foam inner lining and foot bed wick moisture and provide shock absorption. Steel toe cover protects the outsole and improves durability. CE approved. Replacement parts available. Imported.

DESCRIPTION	7	8	9	10	11	12	13	14	15
M1.2 BOOT W/ ATV SOLE									
PART #	3410-0907	0908	0909	0910	0911	0912	0913	0914	0915



DESCRIPTION	PART #	SUG. RETAIL
M1.2 BOOT REPLACEMENT PARTS		
BUCKLE KIT-BLACK	3430-0426	\$4.95
STRAP KIT-BLACK	3430-0430	\$4.95
STRAP LARGE-BLACK	3430-0466	\$4.95
TOE CAP KIT	3430-0434	\$3.95

MUD RAIN SUIT > \$59.95

Ultra-lightweight breathable rain suit. Bomber style jacket, has a full-cut design which allows this suit to be worn over insulated clothing, yet the lightweight material also makes this suit very compact and easy to store. Stuff sack included. Nylon zippers and nickel-plated snaps that eliminate the worry of rust even in snow and salt water conditions. Sold as a set. Made in the USA.

JACKET

Fully adjustable attached tuck away hood with zip closure. 1" elastic waist and wrist bands. Front zipper closure with snap storm flap.

PANTS

1" waist band with adjustable locking shock cord. 1" ankle band with 8" zipper leg openings. Easy access pass through pockets. Expanded 4" back rise for added protection.



SIZE	PART #
SM (WAIST 30"-34")	2851-0369
MD (WAIST 34"-38")	2851-0370
LG (WAIST 38"-42")	2851-0371
XL (WAIST 42"-46")	2851-0372
2X (WAIST 46"-50")	2851-0373
3X (WAIST 50"-54")	2851-0374

**RIDING GLOVE** > \$29.95

Designed for the hunter or ATV rider. Lycra material with cow hide napskin leather on the top of the glove. Neoprene cuff with a hook-and-loop closure and fleece lined for added warmth. Clarino palm with thin foam padding, leather inner thumb and tac-grip on 4 fingers for increased grip. Imported.



SIZE	PART #
SM	3330-1723
MD	3330-1724
LG	3330-1725
XL	3330-1726
2X	3330-1727

**AXIS GLOVE** > \$39.95

The ultimate glove designed for the hunter or ATV rider. Stretch twill backhand provides lightweight, stretch fit. Waterproof, windproof and breathable Hipora® inner liner. Pre-curved, rolled finger design for ergonomic fit. Axe Suede® palm with overlay panel wicks away moisture. Tac-grip rubber on palm and fingers for better grip. Backhand insulation for warmth and wind protection on cold days. Imported.

SIZE	PART #
SM	3330-2891
MD	3330-2892
LG	3330-2893
XL	3330-2894
2X	3330-2895

**M.U.D. HAT** > \$19.95

Bright, embroidered graphics. Adjustable. Imported.

DESCRIPTION	PART #
M.U.D. HAT	2501-1723

**M.U.D. HOODED SWEATSHIRT** > \$39.95

10oz, 80% cotton, 20% polyester. Direct screen printed graphics. Made in the USA.

SIZE	PART #
MD	3050-2244
LG	3050-2245
XL	3050-2246
2X	3050-2247

PLOWS

WINCHES

UTV

RACKS

LUGGAGE

BODY

CONTROLS

ELECTRICAL

WHEELS & TIRES

SUSPENSION & DRIVE

ENGINE

NRA BY MOOSE

RIDER

TOWING

GARAGE

PROMO



MONARCH PASS™ JACKET > \$399.95-\$439.95

D30 EVO PRO CE Level 2 approved shoulder and elbow protection. D30 VIPER1 CE approved back protection. Removable insulated internal vest. Durable high denier reflective nylon panels in shoulder, elbow and side panels. High visibility reflective logos and graphics for increased visibility in low light conditions. Moose technically advanced HDWB (Highly Durable Waterproof Breathable) nylon shell. Well placed chest vents, underarm vents, back vents for maximum temperature regulation. Hook-&-loop waist to secure jacket and back protection into place. Waterproof map pocket placed on placket for easy access. Neck and bottom hem cinch cord to seal out the elements. Unique split front placket allows for easy access to internal pockets. Articulated arms with stretch material in elbow area provide increased comfort and ease of movement. Laser cut / welded wrist closure seals out the elements and provide easy wrist closure adjustment. Four waterproof pockets for storing ride critical items. Internal zippered in pocket with media cord port. Expandable back hydration pocket with internal tube port (bladder not included). Internal perforated poly mesh liner wicks moisture and increases comfort. Imported.

SIZE	PART #
SM	2920-0372
MD	2920-0373
LG	2920-0374
XL	2920-0375
2X	2920-0376
3X	2920-0377



MONARCH PASS™ PANT > \$299.95-\$329.95

D3O EVO PRO CE Level 2 approved hip and knee protection. Durable high denier reflective nylon panels in knee and hip panels for increased visibility and abrasion resistance. Internal boot gator seals out elements. High visibility reflective logos and graphics for increased visibility in low light conditions. Moose technically advanced HDWB (Highly Durable Waterproof Breathable) nylon shell. Well placed front and back vents for maximum temperature regulation. 3-Point waist adjustment system and locking YKK zipper provide maximum closure strength and waist adjustment – (2) hook-and-loop waist adjusters (1) cam-lock waist closure. Zip-off bib provides increased warmth and secure fit. Lower leg adjustment straps seal out the elements and provides secure D3O knee protector fitment. Full Grain leather on inner knee provides increased durability and maximum heat resistance. Four waterproof pockets for storing ride critical items. Internal perforated poly mesh liner wicks moisture and increases comfort. Stretch back waist panel for increased stretch and rider flexibility. Articulated pattern design for maximum movement and rider comfort. Imported.

SIZE	PART #
30	2901-4357
32	2901-4358
34	2901-4359
36	2901-4360
38	2901-4361
40	2901-4362
42	2901-4363
44	2901-4364
46	2901-4365
48	2901-4366



MONARCH PASS™ GLOVE > \$34.95-\$44.95

Open flow stretch mesh finger gussets for increased hand cooling. Twill spandex backhand provides a non-restrictive, lightweight and stretch fit. High-quality sublimated graphics are breathable and non-fading. Pre-curved pinched finger end and palm design provide ergonomic fit. Axe Suede® Deuce synthetic palms wicks moisture and provides superior palm protection. Axe Suede® overlay panels for added palm durability and protection. Tacky screen print on finger tips and palm for added control. Ultra lightweight, stretch fit, slip on design. Available in short and long versions. Imported.

SIZE	SHORT	LONG
	PART #	PART #
XS	3330-2777	3330-2784
SM	3330-2778	3330-2785
MD	3330-2779	3330-2786
LG	3330-2780	3330-2787
XL	3330-2781	3330-2788
2X	3330-2782	3330-2789
3X	3330-2783	3330-2790

- PLOWS
- WINCHES
- UTV
- RACKS
- LUGGAGE
- BODY
- CONTROLS
- ELECTRICAL
- WHEELS & TIRES
- SUSPENSION & DRIVE
- ENGINE
- NRA BY MOOSE
- RIDER**
- TOWING
- GARAGE
- PROMO

EXPEDITION™



EXPEDITION™ JACKET > \$174.95-\$189.95

High visibility reflective logos, piping and graphics for increased visibility in low light conditions. Moose Racing technically advanced HDWB (Highly Durable Waterproof Breathable) nylon shell. Well placed chest vents, underarm vents, back vents for maximum temperature regulation. Micro fleece lined collar for increase comfort and moisture wicking. Waterproof map pocket on inside of placket for easy access. Neck and bottom hem cinch cord to seal out the elements. Articulated arms with stretch material in elbow area provide increased comfort and ease of movement. Laser cut / welded wrist closure seals out the elements and provide easy wrist closure adjustment. Three cargo pockets for storing ride critical items. Internal zippered in pocket with media cord port. Internal perforated poly mesh liner wicks moisture and increases comfort. Fleece lined hand warmer pocket. Includes compact self-storage system, jacket converts into fanny pack. Imported.

SIZE	PART #
SM	2920-0365
MD	2920-0366
LG	2920-0367
XL	2920-0368
2X	2920-0369
3X	2920-0370
4X	2920-0371

EXPEDITION™ VEST > \$79.95

High visibility reflective logos for increased visibility in low light conditions. Moose Racing technically advanced windproof and water resistant nylon shell. Well placed chest vents and large rear poly mesh panel for maximum air flow and temperature regulation. Micro fleece lined collar for increase comfort and moisture wicking. Map pocket on inside of zipper placket is shielded from the element and easy to access. Neck and bottom hem cinch cord to seal out the elements. Internal zippered media pocket with media cord port. Internal perforated poly mesh liner wicks moisture and increases comfort. Fleece lined hand warmer pocket. Imported.

SIZE	PART #
MD	2930-0033
LG	2930-0034
XL	2930-0035
2X	2930-0036

**EXPEDITION™ PANT** > \$149.95-\$169.95

High visibility reflective logos and graphics for increased visibility in low light conditions. Moose Racing technically advanced HDWB (Highly Durable Waterproof Breathable) nylon shell. Well placed front and back vents for maximum temperature regulation. 3-Point waist adjustment system and locking YKK zipper provides maximum closure strength and waist adjustment – (2) hook-&-loop waist adjusters (1) cam-lock waist closure. Lower leg adjustment strap seals out the elements. Full grain leather on right inner knee provides maximum heat resistance. Four cargo pockets for storing ride critical items. Internal perforated poly mesh liner wicks moisture and increases comfort. Stretch back waist and hip panels for increased stretch and rider flexibility. Articulated pattern design for maximum movement and rider comfort. Imported.

SIZE	PART #
30	2901-4346
32	2901-4347
34	2901-4348
36	2901-4349
38	2901-4350
40	2901-4351
42	2901-4352
44	2901-4353
46	2901-4354
48	2901-4355
50	2901-4356



PLOWS

WINCHES

UTV

RACKS

LUGGAGE

SUSPENSION
& DRIVE

ENGINE

NRA
BY MOOSE

RIDER

TOWING

GARAGE

PROMO

QUALIFIER



QUALIFIER™ JERSEY > \$29.95-\$34.95

High quality polyester chassis is breathable and wick moisture. V-neck collar and neck taping for maximum comfort. Generous fit and raglan-style sleeves for full range movement. High-quality sublimated graphics. Non-restrictive durable stretch polyester mini cuffs. Imported.

SIZE	BLUE	ORANGE	RED	STEALTH
SM	2910-2969	2910-2977	2910-2985	2910-2993
MD	2910-2970	2910-2978	2910-2986	2910-2994
LG	2910-2971	2910-2979	2910-2987	2910-2995
XL	2910-2972	2910-2980	2910-2988	2910-2996
2X	2910-2973	2910-2981	2910-2989	2910-2997
3X	2910-2974	2910-2982	2910-2990	2910-2998
4X	2910-2975	2910-2983	2910-2991	2910-2999
5X	2910-2976	2910-2984	2910-2992	2910-3000



QUALIFIER™ GLOVE > \$22.95

Spandex and dimple mesh backband provides an non-restrictive and secure fit. Thermoplastic resin logo on back hand for increased roost protection. High-quality sublimated graphics are breathable and non-fading. Pre-curved pinched finger end and palm design provide ergonomic fit. Axe Suede® Deuce synthetic palms wicks moisture and provides superior palm protection. Tacky screen print on finger tips and palm for added control. Lightweight, stretch fit, slip on design. Imported.

SIZE	BLACK	BLUE	ORANGE	RED	STEALTH
SM	3330-2680	3330-2686	3330-2692	3330-2698	3330-2704
MD	3330-2681	3330-2687	3330-2693	3330-2699	3330-2705
LG	3330-2682	3330-2688	3330-2694	3330-2700	3330-2706
XL	3330-2683	3330-2689	3330-2695	3330-2701	3330-2707
2X	3330-2684	3330-2690	3330-2696	3330-2702	3330-2708
3X	3330-2685	3330-2691	3330-2697	3330-2703	3330-2709

**QUALIFIER™ PANT** > \$74.95-\$84.95

High-denier polyester chassis is durable. Sublimated graphics are breathable and non-fading. Oversized knee area with high-denier nylon inner panels. Pre-bent pant leg design and spandex stretch panels for increased mobility. 3-point waist adjustment system allow you to fine tune fit. 1000 denier nylon panels in high wear areas. Imported.

SIZE	BLUE	ORANGE	RED	STEALTH
28	2901-4187	2901-4201	2901-4215	2901-4229
30	2901-4188	2901-4202	2901-4216	2901-4230
32	2901-4189	2901-4203	2901-4217	2901-4231
34	2901-4190	2901-4204	2901-4218	2901-4232
36	2901-4191	2901-4205	2901-4219	2901-4233
38	2901-4192	2901-4206	2901-4220	2901-4234
40	2901-4193	2901-4207	2901-4221	2901-4235
42	2901-4194	2901-4208	2901-4222	2901-4236
44	2901-4195	2901-4209	2901-4223	2901-4237
46	2901-4196	2901-4210	2901-4224	2901-4238
48	2901-4197	2901-4211	2901-4225	2901-4239
50	2901-4198	2901-4212	2901-4226	2901-4240
52	2901-4199	2901-4213	2901-4227	2901-4241
54	2901-4200	2901-4214	2901-4228	2901-4242

**QUALIFIER™ OVER THE BOOT** > \$79.95

High-denier polyester chassis is durable. Sublimated graphics are breathable and non-fading. Oversized knee area with high-denier nylon inner panels. Pre-bent pant leg design and spandex stretch panels for increased mobility. 3-point waist adjustment system allow you to fine tune fit. 1000 denier nylon panels in high wear areas. Over the boot design with zipper leg opening. Imported.

SIZE	STEALTH
28	2901-4243
30	2901-4244
32	2901-4245
34	2901-4246
36	2901-4247
38	2901-4248
40	2901-4249
42	2901-4250
44	2901-4251



GARMENT SIZING INFORMATION

The charts below will help you select the proper size. If you have any questions, please contact us through our web site at moosecomments@mooseraiding.com or contact your nearest Parts Unlimited dealer.

CARE INSTRUCTIONS

Moose does not recommend dry cleaning for any of our products. All of our products are machine washable. You should use a commercial front loading machine and follow the care instructions for each garment.

PANTS DIAGRAM 1

The sizing information below will help you select the proper size. Sizing by measurement in inches. Inseam Measurement: Measure from the crotch to the bottom of the leg. (B) Race pants will have shorter inseam to accommodate wearing the pant on the inside of boots, outerwear pants will be more similar to casual pants as these are designed to be worn over boots.

RACEWEAR PANTS: QUALIFIER		
SZ	WAIST CINCHED/STRETCHED [A]	INSEAM [B]
28	27" - 30"	29"
30	29" - 32"	29"
32	31" - 34"	30"
34	33" - 36"	31"
36	35" - 38"	32"
38	37" - 40"	32"
40	39" - 42"	33"
42	41" - 44"	33"
44	43" - 44"	33"
46	45" - 48"	33"
48	47" - 50"	33"
50	48" - 52"	33"
52	50" - 54"	33"
54	52" - 56"	33"

MONARCH PASS PANTS		
SZ	WAIST CINCHED/STRETCHED [A]	INSEAM [B]
30	31 1/2"	31 1/4"
32	33 1/2"	32"
34	35 1/2"	32 3/4"
36	37 1/2"	33 1/2"
38	39 1/2"	34"
40	41 1/2"	34"
42	43 1/2"	34"
44	45 1/2"	34"
46	47 1/2"	34"
48	49 1/2"	34"

EXPEDITION PANTS		
SZ	WAIST CINCHED/STRETCHED [A]	INSEAM [B]
30	29 1/2"	30 1/2"
32	31 1/2" - 34"	31 1/4"
34	33 1/2" - 36"	32"
36	35 1/2" - 38"	32 3/4"
38	37 1/2" - 40"	33 1/2"
40	39 1/2" - 42"	34"
42	41 1/2" - 44"	34"
44	43 1/2" - 46"	34"
46	45 1/2" - 48"	34"
48	47 1/2" - 50"	34"
50	49 1/2" - 52"	34"

GLOVES DIAGRAM 2

Hand measurement: Measure around the fullest part of the hand not including the thumb.

MENS GLOVES	
SZ	HAND CIRCUMFERENCE [E]
XS	6" - 7"
SM	7" - 8"
MD	8" - 9"
LG	9" - 10"
XL	10" - 11"
2XL	11" - 12"
3XL	12" - 13"

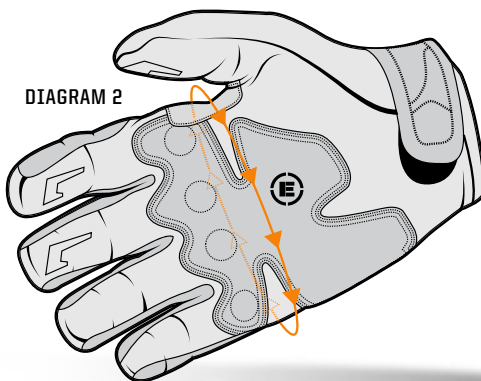

JERSEYS DIAGRAM 1

Chest measurement: With tape level, measure around the fullest part of the chest, just under the arms and around the shoulder blades. (C)
 Sleeve measurement: With elbow slightly bent, measure from the center back of neck, over point of shoulder, around elbow and down to 1/2" past wrist bone. (D) Jerseys are generously sized for comfort, mobility, and to be worn over low profile roost shields/guards.

RACEWEAR JERSEYS: QUALIFIER		
SZ	CHEST [C]	SLEEVE LENGTH [D]
SM	41" - 43"	33" - 34"
MD	43" - 45"	34" - 35"
LG	45" - 47"	35" - 36"
XL	47" - 49"	36" - 37"
2XL	49" - 51"	37" - 38"
3XL	51" - 53"	38" - 39"
4XL	53" - 55"	39" - 40"
5XL	55" - 57"	40" - 41"

JACKETS DIAGRAM 1

Chest measurement: With tape level, measure around the fullest part of the chest, just under the arms and around the shoulder blades. (C)
 Sleeve measurement: With elbow slightly bent, measure from the center back of neck, over point of shoulder, around elbow and down to 1/2" past wrist bone. (D) Jackets are generously sized for comfort, mobility, and to be worn over low profile roost shields/guards.

OUTERWEAR JACKETS: MONARCH PASS/EXPEDITION/VEST		
SZ	CHEST [C]	SLEEVE LENGTH [D]
SM	41" - 43"	33" - 34"
MD	43" - 45"	34" - 35"
LG	45" - 47"	35" - 36"
XL	47" - 49"	36" - 37"
2XL	49" - 51"	37" - 38"
3XL	51" - 53"	38" - 39"
4XL	53" - 55"	39" - 40"

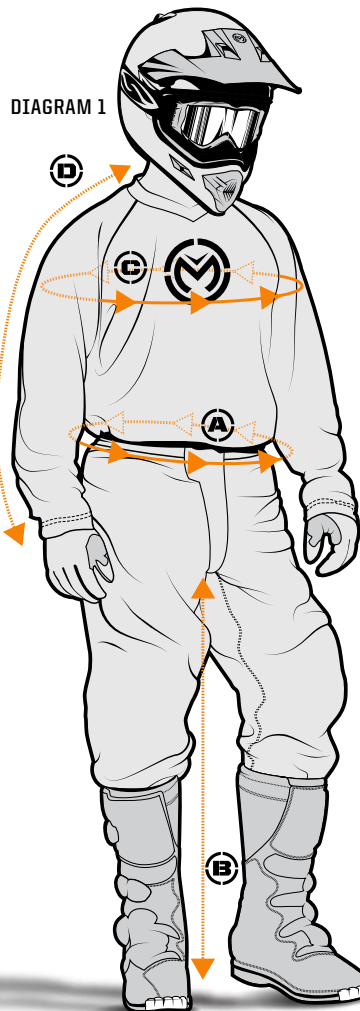

PLOWS
 WINCHES
 UTV
 RACKS
 LUGGAGE
 BODY
 CONTROLS
 ELECTRICAL
 WHEELS & TIRES
 SUSPENSION & DRIVE
 ENGINE
 NRA BY MOOSE
 RIDER
 TOWING
 GARAGE
 PROMO

SIDE EXTENSIONS



TRAILERS AND MESH EXTENDERS > \$128.95-\$591.95

Molded high-density polyethylene plastic. 1.25" diameter axle and high speed 4-bolt trailer hubs. Large 8" knobby tires provide excellent flotation. Heavy-duty 1 7/8" ball coupler. Frame tilts for easy unloading. Large measures 55" L x 26" W x 13" H (12 cubic foot capacity). Regular measures 50" L x 20" W x 10" H (7 cubic foot, 1,000 lb. capacity). Side extensions add a full 10" of extra carrying capacity. Made in the USA.

DESCRIPTION	PART #
REGULAR CARGO TRAILER	M92-21050
LARGE CARGO TRAILER	M92-21060
REGULAR SIDE EXTENSIONS	M9221051
LARGE SIDE EXTENSIONS	M9221061



M92-21050



M92-21060



UTILITY TRAILER > \$371.95

18-gauge steel construction. 10 cubic foot capacity trailer has 1,000 lbs. weight limit. Oil lube roller bearings grease fittings for easy lubrication. 4.00 x 8 pneumatic tires. Features removable tailgate, dump bed. Hitch pin included. Body measures 30" L x 48" W x 12" H. 16 x 6 1/2" x 8" wheels. Made in the USA.

DESCRIPTION	PART #
UTILITY TRAILER	M92-21041



CARGO TUB SLED & TOW BAR > \$59.95-\$128.95

Measures 50" L x 20" W x 10" H; 7 cubic feet. Tow bar full swivel, tension spring hitch. Side extensions add 10" of extra capacity. Tow bar/side extensions sold separately. Made in the USA.

DESCRIPTION	PART #
CARGO TUB SLED	M92-21053
TOW BAR	M92-21052
SIDE EXTENSIONS	M9221051



BALL HITCH CONVERSION KIT > \$39.95

Converts Utility Trailer part # M92-21041 from pin hitch to a ball hitch (for other brands drilling may be required). Powder coated steel connector bracket with galvanized steel coupler. Comes complete with necessary hardware to bolt to cart drawbar. Fits 1 7/8" trailer ball (coupler included). Made in the USA.

DESCRIPTION	PART #
BALL HITCH CONVERSION KIT	4504-0036



4504-0044



4504-0041



4504-0040



4504-0042



4504-0043



4504-0047



4504-0088



4504-0045



4504-0038

REAR RECEIVER HITCHES > \$78.95

2" receiver hitches are frame mounted with a durable powder-coat finish. Provides heavy towing capabilities. Made in the USA.

FITS MODEL

REAR RECEIVER HITCHES	PART #
CAN-AM	
RENEGADE 500/800 07-11	4504-0044
OUTLANDER (ALL) 06-12	4504-0044
HONDA	
RANCHER 420 AT (IND. SUSP) 07-13	4504-0046
RANCHER 420 AT (STRAIGHT AXLE) 07-13	4504-0063
FOREMAN/RUBICON 500 09-13	4504-0063
RINCON 650/680 03-13	4504-0041
KAWASAKI	
BRUTE FORCE 650I/750I (IND SUSP ONLY) 05-13	4504-0040
MULE 610 05-12	4504-0015
POLARIS	
ALL SPORTSMAN W/IND. SUSPENSION (EXCEPT XP, X2, TOURING) 96-12	4504-0042 ¹
RZR/RZR-S/RZR-4 800 08-13	4504-0043
SPORTSMAN 550/850XP 09	4504-0047
SPORTSMAN 550/850XP 10-13	4504-0088
SPORTSMAN 550 TOURING/X2 ONLY 10	4504-0047
SUZUKI	
KING QUAD 450/500/700/750 AXI 05-13	4504-0045
YAMAHA	
GRIZZLY/BIG BEAR 350/400 IRS 07-12	4504-0039
GRIZZLY 450 IRS 11-12	4504-0039
GRIZZLY 550 09-13	4504-0038
GRIZZLY 700 07-13	4504-0039

¹ WILL NOT FIT 05 MODELS



HITCH BALL NOT INCLUDED



HITCH BALL NOT INCLUDED

THREE-WAY 2" RECEIVER HITCH > \$39.95

Gives you the option of using a ball or clevis pin mount. The reversible drop hitch bar is secured by a 5/8" hitch pin with a cotter key and can be quickly removed. The hitch collar mounts to any ATV with a factory hitch. Utilizes standard 2" hitch box. Tow, pull or use a pin hitch without changing hitches. Insert is reversible for trailer hitch height adjustment. Imported.

DESCRIPTION	PART #
THREE-WAY 2" RECEIVER HITCH	M92-41200

THREE-WAY 1-1/4" RECEIVER HITCH > \$49.95

Use ball or clevis mount without changing hitches. Reversible drop hitch bar secured by 5/8" hitch pin. Hitch collar mounts to ATV with factory hitch. Uses standard 1-1/4" hitch box; insert reversible for trailer hitch height adjustment. Mounting hardware included. Imported.

DESCRIPTION	PART #
THREE-WAY 1 1/4" RECEIVER HITCH	4504-0021



HITCH BALL NOT INCLUDED

THREE WAY HITCH > \$29.95

Mounts quickly and easily to any ATVs equipped with factory hitch. Use hitch ball/clevis pin without changing hitches. Tow loop, perfect anchor point for pulling with tow strap/winch cable. Includes 3/4" hardened mounting bolt. Imported.

DESCRIPTION	PART #
THREE WAY HITCH	M92-41100



HITCH BALL NOT INCLUDED

THREE-WAY COMPACT HITCH > \$19.95

Use ball, pin pull, or tow loop without changing hitches. Versatile—handles your hauling/towing needs. Fits ATVs that accept a trailer ball. Mounting hardware included. Imported.

DESCRIPTION	PART #
THREE-WAY COMPACT HITCH	4504-0098



HITCH BALL NOT INCLUDED

PUSH TUBE HITCH > \$41.95

Powder coated steel. Attaches to Moose universal push tube (M93-11001) with use of a bottom mount. Move trailers around with ease. Angled top to make trailering level. Made in the USA.

DESCRIPTION	PART #
PUSH TUBE HITCH	4504-0017



4504-0060



4504-0059



4504-0058



4504-0061

TRIO HD HITCHES > \$41.95-\$69.95

Welded-on 2" ball on a 3" rise. Reinforced tow loop/tie-down point and clevis pin hole. Quiet Tek wedge reduces hitch rattle. Trio Receiver accepts standard accessories. Patent pending "C" channel design guarantees maximum strength and provides a 3" rise for optimal towing height. Mounting hardware and hitch pin included. Imported.

DESCRIPTION	PART #
TRIO HD 1.25" HITCH W/ BALL MOUNT	4504-0060
TRIO HD 2" HITCH W/ BALL MOUNT	4504-0059
TRIO HD RECEIVER HITCH W/ BALL MOUNT	4504-0058
TRIO HD MUTLI-PURPOSE HITCH W/ BALL MOUNT	4504-0061



1-1/4" TO 2" HITCH ADAPTER > \$44.95

Adapt your existing 1-1/4" receiver so you can use your 2" hitch accessories. 1-1/4" outside male end to 2" female inside. Welded D-ring for trailer tie-down or tow point. Includes 1/2" hitch pin and hairpin cotter pin. Black powder coated finish. Imported.

DESCRIPTION	PART #
1-1/4" TO 2" HITCH ADAPTER	4504-0032



4504-0065



4504-0068



4504-0067



4504-0066



4504-0071

TRAILER HITCHES > \$34.95-\$61.95

Heavy-duty steel and powder coated for durability. Fixture welded for precise fit. Mounting hardware and instructions included. Made in the USA.

FITS MODEL	PART #
TRAILER HITCHES	
HONDA	
ATC125M 3-WHEELER 86	4504-0073
TRX125 87-88	4504-0073
ATC185S 3-WHEELER 81-83	4504-0084
TRX200,TYPE II 90-97	4504-0065
TRX200SX 86-88	4504-0073
ATC200S 3-WHEELER 84-86	4504-0084
ATC200M 3-WHEELER 84-85	4504-0084
ATC200 3-WHEELER 81-83	4504-0084
ATC250ES 85-87	4504-0078
ATC250SX 85-87	4504-0078
TRX250 85-87	4504-0078
TRX250 RECON 97-13	4504-0079
TRX350 86-89	4504-0078
TRX680 RINCON 03-13	4504-0064
KAWASAKI	
KEF300 LAKOTA 95-01	4504-0071
KVF650/700 PRAIRIE 4X4 02-03	4504-0072
MULE 610 05-13	4504-0082
POLARIS	
ALL SCRAMBLER, SPORT, TRAILBLAZER 96-11	4504-0080
SUZUKI	
OZARK 250 02-12	4504-0081
YAMAHA	
YFAI 125 BREEZE 89-03	4504-0068
GRIZZLY 125 2X4 05-13	4504-0068
YFM600 GRIZZLY 99-01	4504-0067



4504-0090



4504-0093



4504-0092



4504-0094

FRONT RECEIVER HITCHES > \$89.95

Thick steel construction with a strong receiver tube for superior towing power. Reinforced trim ring for that truck hitch look and increased strength. Works with all standard 2" drawbars. Solid frame mounting using existing attachment points, no drilling required. Includes all hardware and complete instructions. Cutting the front plastic pan required on all models except Ranger and King Quad. Not for use with receiver mounted plows. Made in the USA.

FITS MODEL	PART #
FRONT RECEIVER HITCHES	
CAN-AM	
OUTLANDER 400 13	4504-0090
OUTLANDER (ALL) 06-12	4504-0090
HONDA	
RINCON 650/680 03-13	4504-0093
RANCHER 420 07-13	4504-0094
KAWASAKI	
BRUTE FORCE 650I (IND SUSP ONLY) 11-12	4504-0092
BRUTE FORCE 750 08-12	4504-0092
MULE 610 05-13	4504-0091
POLARIS	
RANGER 500 09-10	4504-0097
RANGER 700 (EXCEPT CREW) 09	4504-0097
RANGER 800 10-12	4504-0097
RANGER DIESEL 11	4504-0097
SUZUKI	
KING QUAD 450/500/700/750 AXI 05-13	4504-0095
YAMAHA	
GRIZZLY 550 09-13	4504-0096
GRIZZLY 700 07-13	4504-0096



4504-0095

PLOW

WINCHES

UTV

RACKS

LUGGAGE

BODY

CONTROLS

ELECTRICAL

WHEELS & TIRES

SUSPENSION & DRIVE

ENGINE

NRA BY MOOSE

RIDER

TOWING

GARAGE

PROMO





PLOWS

WINCHES

UTV

RACKS

LUGGAGE

BODY

CONTROLS

ELECTRICAL

WHEELS & TIRES

SUSPENSION & DRIVE

ENGINE

NRA BY MOOSE

RIDER

TOWING

GARAGE

PROMO



HEAVY-DUTY TIE-DOWNS > \$17.95-\$43.95

High-quality tie-downs that last. 6' long and 1" wide. Two oversized, high-strength rubber coated hooks. Straps are printed with the Moose Utility Division logo. Choice of standard, ratchet or quad pack which includes both. Ratchet-2,000 lb.; Standard-1,350 lb. Made in the USA.

DESCRIPTION	PART #
1" STANDARD TIE-DOWNS	
BLACK	3920-0294
RED	3920-0295
BLUE	3920-0296
1" RATCHET TIE-DOWNS	
BLACK	3920-0297
RED	3920-0298
BLUE	3920-0299
QUAD PACK-TIE-DOWNS 1 PAIR RATCHET/1 PAIR STANDARD	
BLACK	3920-0300



SHOCK WEAVE TIE-DOWN ENHANCERS > \$18.95

Automatically compensates for up to 3" of slack and eliminates tangles with built-in strap keepers. Provides 135 pounds of dynamic tension. Imported.

DESCRIPTION	PART #
SHOCK WEAVE TIE-DOWN ENHANCERS	3920-0241



1" SOFT TIE EXTENSIONS > \$5.95

Perfect for bars or secure areas too thick for hooks. Won't scratch paint or plastic. 18" length. 4,500 lb. test nylon webbing. Made in the USA.

DESCRIPTION	PART #
BLACK	3920-0307
RED	3920-0308
BLUE	3920-0309



CARABINER TIE-DOWN > \$21.95

Makes securing your machine an easier job. One high-strength rubber coated hook and one high-strength carabiner. 1" wide straps are printed with the Moose Racing logo and identification tag. Built in soft tie helps prevent damage to your machine. 7' long (1' longer than industry standard), 1,350 lb. break strength. 425 lb. working load limit. Sold in pairs. Made in the USA.

DESCRIPTION	PART #
BLACK	3920-0305
RED	3920-0355
BLUE	3920-0356
ORANGE	3920-0357

TOW STRAP > \$14.95

15' polyester strap with two heavy-duty forged steel hooks. 10,000 lb. tensile strength. Made in the USA.

DESCRIPTION	PART #
TOW STRAP	3920-0306



SWIVEL CARABINER TIE-DOWN > \$38.95-\$45.95

6' long and 1.5" wide. Oversized high-strength rubber coated hook on one end. Swivel carabiner hook means no more twisted straps. Standard weight capacity; 1,850 lb. Ratchet weight capacity; 2,000 lb. Sold in pairs. Made in the USA.

DESCRIPTION	PART #
STANDARD	3920-0338
RATCHET	3920-0339



3910-0008
42" - 52" W X 76" L; 1,250 lb. capacity



MUDRAMP4685
46" W x 85" L; 1,200 lb. capacity

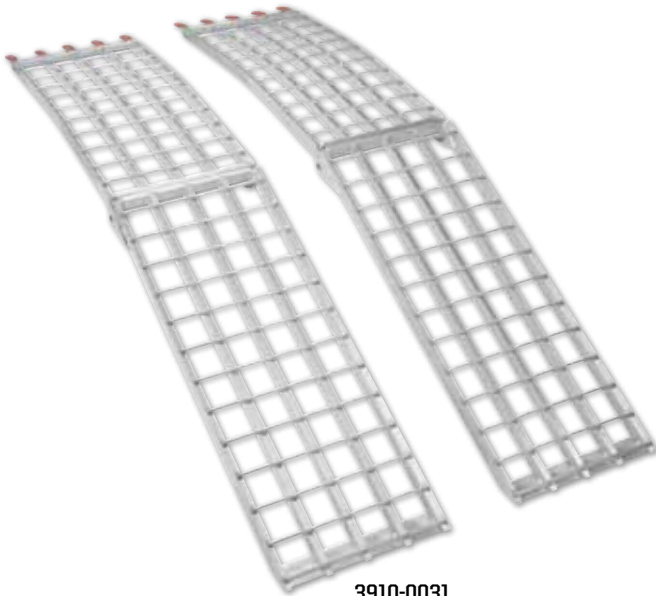

3910-0031
18" W X 95" L each; 2,500 lb. capacity



MUDRAMP4871
48" W x 71" L; 1,000 lb. capacity



MUDRAMP1290P
12" W x 90" L each; 1,200 lb. capacity

ALUMINUM RAMPS > \$9.95-\$479.95

Durable and lightweight. Weather resistant and comes with sturdy aluminum frames. Bar style surface for better traction. Come with EZ grip rubber rests and nylon straps. Imported.
WARNING: DO NOT RIDE ON RAMPS AT ANYTIME.

DESCRIPTION	PART #
TRI-FOLD ADJUSTABLE ALUMINUM RAMP	
42" - 52" W X 76" L	3910-0008
TRI-FOLD ALUMINUM RAMP	
46" W X 85" L	MUDRAMP4685
UTV ALUMINUM RAMP	
18" W X 95" L (SOLD IN PAIRS)	3910-0031
BI-FOLD ADJUSTABLE ALUMINUM RAMP	
48" W X 71" L	MUDRAMP4871
ARCHED FOLDING ALUMINUM RAMP	
12" W X 90" L (SOLD IN PAIRS)	MUDRAMP1290P
RAMP REPLACEMENT STRAPS	3910-0028

PLOWS

WINCHES

UTV

RACKS

LUGGAGE

BODY

CONTROLS

ELECTRICAL

WHEELS & TIRES

SUSPENSION & DRIVE

ENGINE

NRA BY MOOSE

RIDER

TOWING

GARAGE

PROMO



PLASTIC CLEANER > \$7.95

Cleans all types of plastic surfaces and reduces glare. Anti-static, anti-fog, non-streaking and fast drying. Foaming action prevents product from dripping. 20 fl. oz., 19 oz. net weight, 12 per case; sold each. Made in the USA.

DESCRIPTION	PART #
PLASTIC CLEANER	3713-0031



DEGREASER > \$6.95

For use on virtually every substrate (except fabric). Forceful spray helps knock off dirt, mud and grime. Removes grease/oil. Quick evaporation with no residue. 20 fl. oz., 14 oz. net weight, 12 per case; sold each. Made in the USA.

DESCRIPTION	PART #
DEGREASER	3704-0096



CHAIN LUBE > \$8.95

Penetrates rapidly. Ideal for all types of exposed chains. Reduces friction and wear. Resists rust and corrosion. Heat stable to 500 degrees. 20 fl. oz., 15 oz. net weight, 12 per case; sold each. Made in the USA.

DESCRIPTION	PART #
CHAIN LUBE	3605-0025



HEAVY-DUTY CHAIN LUBE > \$9.95

Foaming action. Penetrates rapidly. Preserves O-Rings. Reduces friction and wear. Resists rust and corrosion. 20 fl. oz., 15 oz. net weight, 12 per case; sold each. Made in the USA.

DESCRIPTION	PART #
HEAVY DUTY CHAIN LUBE	3605-0026



CABLE LIFE > \$8.95

Extends life of cables. Cleans and lubricates. Heat stable. Will lubricate inside and out. Retards corrosion and never dries. 20 fl. oz., 16 oz. net weight, 12 per case; sold each. Made in the USA.

DESCRIPTION	PART #
CABLE LIFE	3607-0019



SILICONE SPRAY > \$7.95

Protective spray for metal, rubber, and plastic surfaces. Protects rubber from freezing. Gives plastic a new gloss. Coats to prevent mud from sticking. 20 fl. oz., 11 oz. net weight, 12 per case; sold each. Made in the USA.

DESCRIPTION	PART #
SILICONE SPRAY	3713-0030



BRAKE PARTS CLEANER > \$6.95

Quickly removes dirt, grease, brake fluid and grime from critical brake components.

Flushes away contaminants without disassembling the brake unit. Non-chlorinated, hexane free 1,1,1, trichloroethane free. 10% voc formula; voc compliant in 50 states. High pressure spraying, fast evaporating. Restores smooth brake operation. 20 fl. oz., 15 oz. net weight, 12 per case; sold each. Made in the USA.

DESCRIPTION	PART #
BRAKE PARTS CLEANER	3704-0189



CONTACT CLEANER > \$8.95

Quick drying. Leaves no residue. Safe on most plastics. Prevents corrosion by displacing moisture. Effectively removes soil & other contaminants from electrical components. 20 fl. oz., 13.5 oz. net weight, 12 per case; sold each. Made in the USA.

DESCRIPTION	PART #
CONTACT CLEANER	3704-0107



INSTANT DETAIL CLEANER > \$6.95

Spray & wipe clean. Showroom quality shine. Rinse free. For any plastic & hard surface. Will not attack paint. Prevents build up of dirt & mud. 20 fl. oz., 16 oz. net weight, 12 per case; sold each. Made in the USA.

DESCRIPTION	PART #
INSTANT DETAIL CLEANER	3713-0040



CAN RACK > \$30.95

Holds cans and oil bottles. Attaches to a trailer or garage wall. Contents not included. Made in the USA.

DESCRIPTION	PART #
CAN RACK	M92-21180



TIRE SEALANT > \$17.95

Seals up to 1/2" puncture in the tread and 1/4" puncture in the sidewall. Stops bead leaks, valve stem leaks and pinhole leaks in rims. Will not solidify or freeze (above -33F). Will not rust steel, corrode aluminum wheels, or clog valve core. Biodegradable and water soluble. Works for the life of the tire. Not recommended for extreme high speed competition applications. Available in 32 oz. bottle. One bottle needed to treat one average utility ATV tire. Made in the USA.

DESCRIPTION	PART #
TIRE SEALANT	3715-0013



ULTIMATE TIRE REPAIR KIT > \$35.95

All you need to repair and inflate your tire on the road or trail. Padded nylon zippered carrying case easily stores inside fanny pack or tool compartment. Each cartridge produces 8-9 psi. 4" inflator hose accepts threaded cartridges only. Kit includes: 1 large oblong patch, 2 medium size patches, 3 small patches, thumb buffer, .50 oz tube of rubber cement, 5 4" rubber insert strips, insertion tool with screwdriver handle, reamer/rasp tool with screwdriver handle, 3 16 gram 3/8" threaded CO2 cartridges and CO2 4" inflator hose. Replacement threaded cartridges (6 pack) available, part # 0363-0060. Made in the USA. NOTE: CO2 CARTRIDGES CANNOT BE TRANSPORTED ON AN AIRCRAFT

DESCRIPTION	PART #
ULTIMATE TIRE REPAIR KIT	0364-0033



TIRE INFLATOR KIT > \$24.95

Don't leave yourself stranded. The Moose Racing tire inflator kit gets you back on the road or trail quickly. Inflator accepts threaded CO2 cartridges only. 4" inflator hose included. 3 16 gram 3/8" threaded cartridges included. Each cartridge produces 8-9 psi. Replacement threaded cartridges (6 pack) available, part # 0363-0060. Made in the USA.

NOTE: CO2 CARTRIDGES CANNOT BE TRANSPORTED ON AN AIRCRAFT

DESCRIPTION	PART #
TIRE INFLATOR KIT	0364-0063



CO2 REPLACEMENT CARTRIDGES > \$16.95-\$20.95

16 gram cartridges in threaded and non-threaded styles. Threaded cartridges have 3/8" threading. For all CO2 tire inflators. Sold in 6 packs. Imported.

NOTE: CO2 CARTRIDGES CANNOT BE TRANSPORTED ON AN AIRCRAFT

DESCRIPTION	PART #
16 GRAM NON-THREADED CO2 REPLACEMENTS 6 PACK	0363-0061
16 GRAM THREADED CO2 REPLACEMENTS 6 PACK	0363-0060



CO2 FISH BOWL > \$3.50 (EA)

Keep the right quantity of CO2 cartridges on hand. Fish bowl display contains 20 16 gram 3/8" threaded CO2 cartridges. Made in the USA. NOTE: CO2 CARTRIDGES CANNOT BE TRANSPORTED ON AN AIRCRAFT

DESCRIPTION	PART #
CO2 FISH BOWL	0363-0062

4 IN 1 MAGNETIC SCREWDRIVER > \$2.95 (EA)

Fishbowl display contains 20 screwdrivers. Each screwdriver contains extension, two Phillips and two flat bits. Great for tool and fanny packs. Made in the USA.

DESCRIPTION	PART #
4 IN 1 MAGNETIC SCREWDRIVER	3850-0092



10 PC HEX WRENCH SET > \$8.95

Made from high-quality chrome vanadium. Comes with plastic holder. Includes sizes 1.5mm thru 10mm. Imported.

DESCRIPTION	PART #
10 PC HEX WRENCH SET	3812-0043



HEX WRENCH > \$19.95

Conveniently sized "Y" handle wrench fits perfectly in your fanny pack or bike pack. 8-in-1 wrench. 3 Allen head sizes: 4 mm, 5 mm, and 6 mm. 5 socket sizes: 8 mm, 10 mm, 12 mm, 13 mm, and 14 mm. Imported.

DESCRIPTION	PART #
HEX WRENCH	3850-0114



2-PIECE FUNNEL > \$10.95

Multi-use 2 piece funnel. 12" detachable flexible spout. Includes easy grip handle. 15" overall length. 6" diameter. 3/4" O.D. tip. Imported.

DESCRIPTION	PART #
2-PIECE FUNNEL	3850-0202



EASY POUR FLEX SPOUT > \$7.95

Multi-purpose flexible funnel spout. Double threads to fit most containers. Complete with stopper cap and hang tab. 9.25" length. 3/4" O.D. tip. Imported.

DESCRIPTION	PART #
EASY POUR FLEX SPOUT	3850-0201



QUICKSTEEL EPOXY > \$4.95

Essential pack item. Permanently bonds most surfaces, including steel, aluminum, magnesium and most plastics. Neat, easy to use putty cures steel-hard in 15 minutes. Withstands high engine temperatures. Made in the USA.

DESCRIPTION	PART #
QUICKSTEEL EPOXY	M01060

PLOWS

WINCHES

UTV

RACKS

LUGGAGE

BODY

CONTROLS

ELECTRICAL

WHEELS & TIRES

SUSPENSION & DRIVE

ENGINE

NRA BY MOOSE

RIDER

TOWING

GARAGE

PROMO



MUDSTKR



MUDSTKR4

DESCRIPTION	PART #	SUG. RETAIL
M.U.D. STICKER 5"	MUDSTKR	\$1.00
HUNTING STICKER 5"	MUDSTKR-4	\$1.25



M48-914



M48-915

DESCRIPTION	PART #	SUG. RETAIL
M.U.D. METAL SIGN (14.25" H X 33" W)	M48-914	\$36.95
ATV HUNTING METAL SIGN (14.25" H X 33" W)	M48-915	\$32.95



9904-0985



9904-0986



M48-913



M48-916

DESCRIPTION	PART #	SUG. RETAIL
M.U.D. TRACK BANNER (36" X 84")	9904-0985	\$21.95
M.U.D. SHOP BANNER (23" X 47")	9904-0986	\$14.95
HUNTING SHOP BANNER (18" X 29")	M48-913	\$8.95
MOOSE PLOW BANNER (24" X 36")	M48-916	\$11.95



DESCRIPTION	PART #	SUG. RETAIL
NRA BY MOOSE STICKER 6" (10 PACK)	4320-0769	\$1.95



DESCRIPTION	PART #	SUG. RETAIL
NRA BY MOOSE BANNER (23" X 47")	9904-0470	\$16.95



DESCRIPTION	PART #	SUG. RETAIL
NRA BY MOOSE 3" KEYCHAIN (10 PK)	9904-0820	\$.75





OUR PARTNERS



SPECIAL THANKS TO:



- PROMO
- GARAGE
- TOWING
- RIDER
- NRA BY MOOSE
- ENGINE
- SUSPENSION & DRIVE
- WHEELS & TIRES
- ELECTRICAL
- CONTROLS
- BODY
- LUGGAGE
- RACKS
- UTV
- WINCHES
- PLOWS

REALTREE AP HD



3501 KENNEDY ROAD | JANESVILLE, WISCONSIN 53545

WWW.MOOSEUTILITIES.COM



DISTRIBUTED EXCLUSIVELY BY:



MOOSE UTILITY DIVISION IS A REGISTERED TRADEMARK. ALL RIGHTS RESERVED. NATIONAL RIFLE ASSOCIATION/NRA IMAGES AND LOGOS ARE TRADEMARKS OF THE NRA USED UNDER LICENSE TO LEMANS CORPORATION. NRA MEMBER DUES OR CONTRIBUTIONS ARE NOT USED FOR THIS PROMOTION, PROGRAM OR ANY OTHER RELATED EXPENSES. REALTREE AP HD 2006 © OF JORDAN OUTDOOR ENTERPRISES, LTD. COPYRIGHT 2013. LEMANS CORPORATION. THESE MATERIALS MAY NOT BE COPIED OR REPRODUCED IN ANY MANNER WITHOUT WRITTEN PERMISSION OF LEMANS CORPORATION. PRINTED IN THE USA.

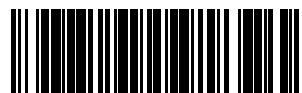

9901-1472