



DRAG
Specialties

PARTS
UNLIMITED

Victory® is a registered trademark of Polaris Industries, Inc.
Indian® is a registered trademark of Indian Motorcycle International, LLC

**2017 PARTS &
ACCESSORIES
FOR VICTORY & INDIAN
MOTORCYCLES**





FUELING THE MARKET

The Victory and Indian V-Twin market is running strong, and the **2017 PARTS UNLIMITED/Drag Specialties Victory & Indian Catalog** is ready to meet this demand and fuel your dealership for 2017! We've expanded our catalog to include even more parts and accessories from the top brands – everything from custom exhausts to seats, windshields and more!

Combine this catalog with the other Drag Specialties and Parts Unlimited catalogs, including the all-new *Tires, Tools, Chemicals & Lubricants, Cleaners & Polishes and Transport & Trailer Catalog*, for the best set of sales tools in the industry.

We constantly are adding new products! Please check PartNetWeb and DragNetWeb all year long, as well as the *2017 Parts Unlimited Street* catalog for the latest and greatest products this high-octane industry has to offer!

PARTS UNLIMITED – SUPPORTING THE DEALER, THE CUSTOMER AND THE ENTIRE SPORT.



IMPORTANT INFORMATION: EMISSIONS AND NOISE REGULATIONS

NOTE: The California Air Resources Board ("CARB") does not permit the use of aftermarket emissions-related part(s) that alter the performance of OEM emissions-related devices unless CARB has issued an Executive Order, other than on racing vehicles on closed courses. Check your local laws and manufacturer's information. More California exhaust information is available at www.arb.ca.gov/.

NOTE: Aftermarket products, including but not limited to exhausts, catalytic converters, oxygen sensors, fuel/air controller modules, air filter kits, camshafts, O₂ eliminators, and carburetors and jet kits which alter, modify, or replace emission control devices or systems of an originally compliant highway motorcycle, are not legal for sale or street use in California unless they have been issued a CARB Executive Order. Aftermarket emissions-related products which have not been issued an Executive Order or which are not aftermarket Replacement Parts, as defined in Title 13, California Code of Regulations, Section 1900(b)(2), are authorized for closed circuit race use only. Products shown may be designed, manufactured, intended and sold for closed circuit race use only and use of the same on public roads or lands may be a violation of local, state and/or federal laws. See manufacturer's information and state and local laws to determine what is authorized for your use on your vehicle.

The following emissions-related defined terms are used in this catalog (PARTS WITH THE FOLLOWING DESIGNATIONS IN THIS CATALOG ARE NOT ILLEGAL FOR SALE IN CALIFORNIA UNDER CARB REGULATIONS):

- "CARB E.O." means the specified Executive Order issued by CARB. An Executive Order constitutes an exemption by CARB from CA Vehicle Code 27156 and 38391, for sale of the part number for the make/model/year fitment(s) specified in the Executive Order.
- "Replacement Part" means any aftermarket part intended to replace an original equipment emissions-related part and which is functionally identical to the original equipment part in all respects which in any way affect emissions (including durability), or a consolidated part.
- "Qualified Manufacturer Declared Replacement Part" means any aftermarket part intended to replace an original equipment emissions-related part and which is functionally identical to the original equipment part in all respects which in any way affect emissions (including durability), or a consolidated part, that has been evaluated and declared by the manufacturer to meet this definition and carry this categorization and designation label. This manufacturer has declared in writing that it has documentation, based upon sound engineering judgment, indicating the replacement part does not reduce the effectiveness of any required emission control device and it does not cause the modified vehicle/engine/equipment to exceed applicable emissions standards for that make/model/year fitment(s) advertised.

NOTE: Products shown may not conform to federal, state or local noise regulations.

WARRANTY: There is no warranty on exhaust pipes and mufflers with regard to any discoloration. Discoloration (blueing) is caused by tuning characteristics, i.e. cam timing, carburetor, etc., and is not caused by defective manufacturing. See the Chemicals and Lubes section for products that will help prevent or remove blueing. Check your applicable laws and manufacturer's publication(s) and/or website(s) for manufacturer's warranty, maintenance, safety, mounting and any regulatory compliance/non-compliance information.



TABLE OF CONTENTS

PARTS & ACCESSORIES FOR VICTORY

EXHAUST	6-12
LUGGAGE	13-16
SECURITY	17-18
WINDSHIELDS	19-24
FAIRINGS & BODY	25-33
SEATS & SISSY BARS	34-42
HANDLEBARS & HAND CONTROLS	43-49
FOOTPEGS & FOOT CONTROLS	50-56
LIGHTING	57-59
ELECTRICAL	60-63
WHEELS & ACCESSORIES	64-65
BRAKES & SUSPENSION	66-72
ENGINE	73-76
FUEL/AIR SYSTEMS	77-81
CROSS REFERENCE	125

PARTS & ACCESSORIES FOR INDIAN

EXHAUST	83-88
WINDSHIELDS	89-90
FAIRINGS & BODY	91-95
SEATS & SISSY BARS	96-98
HANDLEBARS & HAND CONTROLS	99-102
FOOTPEGS & FOOT CONTROLS	103-108
LIGHTING	109-110
ELECTRICAL	111-114
WHEELS AND BRAKES	114-117
SUSPENSION	118
ENGINE	119-120
FUEL/AIR SYSTEMS	120-124
CROSS REFERENCE	125
INDEX	126-130



PARTS & ACCESSORIES FOR VICTORY MOTORCYCLES

VICTORY

EXHAUST

LUGGAGE

SECURITY

WINDSHIELDS

FAIRINGS & BODY

SEATS & Sissy BARS

HANDLEBARS & HAND CONTROLS

FOOTPEGS & FOOT CONTROLS

LIGHTING

ELECTRICAL

WHEELS & ACCESSORIES

BRAKES & SUSPENSION

ENGINE

FUEL/AIR SYSTEMS

INDIAN

EXHAUST

WINDSHIELDS

FAIRINGS & BODY

SEATS & Sissy BARS

HANDLEBARS & HAND CONTROLS

FOOTPEGS & FOOT CONTROLS

LIGHTING

ELECTRICAL

WHEELS & BRAKES

SUSPENSION

ENGINE

FUEL/AIR SYSTEMS



1810-2387



1810-2388

ROAD RAGE 2-INTO-1 EXHAUST SYSTEMS FOR VICTORY OCTANE 17

- 2-into-1 equal-length headers
- Stepped 1³/₄" to 1⁷/₈" head pipes
- Utilizes an advanced inner collector for maximum performance
- Short Megaphone or Long Megaphone mufflers available
- Made in the U.S.A.
- Included items: one black muffler with removable baffle, one front/rear head pipe assembly, one black front heat shield, one black upper heat shield, one black rear lower heat shield and one hardware kit for installation

SUG. RETAIL **\$859.95**

DESCRIPTION	PART #	DESCRIPTION	PART #
Short Megaphone muffler	1810-2387	Long Megaphone muffler	1810-2388

DISCLAIMER: NOT LEGAL FOR SALE OR USE IN CALIFORNIA ON ANY POLLUTION CONTROLLED MOTOR VEHICLES. SEE PAGE 3 FOR IMPORTANT EMISSION DEFINITIONS AND REGULATORY COMPLIANCE AND WARRANTY INFORMATION.

ROAD RAGE 2-INTO-1 SYSTEMS WITH B1-STYLE QUICK-CHANGE END CAPS

- Systems feature 1³/₄" to 1⁷/₈" stepped headpipes and 4" B1-style quick-change end cap
- Muffler uses an advanced inner collector for maximum performance
- 16-gauge steel construction
- Oxygen sensor ports and plugs
- Come with black billet end cap with contrasting flutes
- Aggressive exhaust sound
- Left side bag mounting kit included
- Optional end caps available (sold separately)
- Made in the U.S.A.



1810-2127



1811-2487



Bevel



Slash



Fluted

OPTIONAL B1-STYLE QUICK-CHANGE PSEUDO PIPES

- Non-functional left side "muffler looking" pipe that is made to match Bassani Road Rage 2-into-1 System PART #S 1810-2126/1810-2127
- 16-gauge steel construction
- Give bike a twin muffler look
- Feature matching B1-style quick-change design so optional end caps can be used

FITS MODEL

VICTORY

B1-STYLE QUICK-CHANGE SYSTEMS

DESCRIPTION	PART #	SUG. RETAIL
Cross Roads 10-16 and Cross Country 10-16, Cross Country Tour 16, Hardball 12-15, Classic 13-15, Magnum 15-16	1810-2127	\$799.95
	1810-2126	849.95

OPTIONAL B1-STYLE QUICK-CHANGE PSEUDO PIPES

DESCRIPTION	PART #	SUG. RETAIL
Cross Roads 10-16 and Cross Country 10-16, Cross Country Tour 16, Hardball 12-15, Classic 13-15, Magnum 15-16	1811-2487	349.95
	1811-2488	369.95

DESCRIPTION	PART #	SUG. RETAIL
OPTIONAL B1-STYLE QUICK-CHANGE END CAPS		
Black, fluted	1861-0751	\$69.95
Black, bevel	1861-0752	69.95
Polished, slash	1861-0753 ¹	69.95

DESCRIPTION	PART #	SUG. RETAIL
OPTIONAL B1-STYLE QUICK-CHANGE END CAPS (CONT)		
Black, slash	1861-0754 ¹	69.95
Polished, fluted	1861-0755	69.95

¹ Can be rotated to change direction of slash.

ROAD RAGE 2-INTO-1 SYSTEMS

- 1³/₄" headpipe steps up to 1⁷/₈" into the collector to increase flow and improve performance
- Megaphone muffler with billet end cap
- Removable baffle is packed for throaty sound and increased low-end torque
- 16-gauge steel headpipe, muffler and heat shield for strength
- Available with show-quality chrome or black ceramic finish
- O₂ port and plug included
- Available in mid (12") muffler length
- Made in the U.S.A.



1810-2197



1810-2198

FITS MODEL

VICTORY

DESCRIPTION	PART #	SUG. RETAIL
Vegas, Vegas 8-Ball, Kingpin, Gunner, Judge, Boardwalk, High-Ball 06-16	1810-2196	\$759.95
	1810-2197	799.95

FITS MODEL

VICTORY (CONT)

DESCRIPTION	PART #	SUG. RETAIL
Hammer, Jackpot, Vegas Jackpot 06-16	1810-2198	759.95
	1810-2199	799.95

DISCLAIMER: NOT LEGAL FOR SALE OR USE IN CALIFORNIA ON ANY POLLUTION CONTROLLED MOTOR VEHICLES. SEE PAGE 3 FOR IMPORTANT EMISSION DEFINITIONS AND REGULATORY COMPLIANCE AND WARRANTY INFORMATION.

All part numbers in **BOLD MAGENTA** are new this year.

VICTORY

EXHAUST

LUGGAGE

SECURITY

WINDSHIELDS

FAIRINGS & BODY

SEATS & Sissy BARS

HANDLEBARS & HAND CONTROLS

FOOTPEGS & FOOT CONTROLS

LIGHTING

ELECTRICAL

WHEELS & ACCESSORIES

BRAKES & SUSPENSION

ENGINE

FUEL/AIR SYSTEMS

INDIAN

EXHAUST

WINDSHIELDS

FAIRINGS & BODY

SEATS & Sissy BARS

HANDLEBARS & HAND CONTROLS

FOOTPEGS & FOOT CONTROLS

LIGHTING

ELECTRICAL

WHEELS & BRAKES

SUSPENSION

ENGINE

FUEL/AIR SYSTEMS



1810-2174



1810-1991



1810-2205

PRO-STREET SLASH-CUT

- 1³/₄" headpipe steps to 1⁷/₈" into 2¹/₄" muffler body to increase flow and improve performance
- Headpipes include full-coverage heat shields
- Removable baffle
- Includes O₂ sensor ports and plugs
- 16-gauge steel headpipe, muffler and heat shield for strength
- Available with show-quality chrome or black finish
- Slash-cut ends
- Made in the U.S.A.

FITS MODEL

VICTORY	DESCRIPTION	PART #	SUG. RETAIL
Vegas 8-Ball, Kingpin, Kingpin 8-Ball, Highball 02-05	Chrome	1810-2174	\$729.95
	Black	1810-2175	769.95
Vegas, High Ball, Judge, Boardwalk, Kingpin 06-14	Black	1810-1991	669.95
Hammer, Hammer S, Hammer 8-Ball, Jackpot, Vegas Jackpot 05-16	Chrome	1810-2204	659.95
	Black	1810-2205	699.95

DISCLAIMER: NOT LEGAL FOR SALE OR USE IN CALIFORNIA ON ANY POLLUTION CONTROLLED MOTOR VEHICLES. SEE PAGE 3 FOR IMPORTANT EMISSION DEFINITIONS AND REGULATORY COMPLIANCE AND WARRANTY INFORMATION.



1810-1996



1810-1997



1810-2202

PRO STREET TURN OUTS EXHAUST SYSTEMS

- Over-and-under pipes with turn-out ends
- Full-coverage heat shields
- 1³/₄" headpipe steps to 1⁷/₈"; stepped headpipes improve exhaust flow for more power
- Heavy-duty 16-gauge steel construction for long life
- DCB-designed baffle manages flow to improve low-end torque
- Includes all mounting hardware
- Available with chrome or black finish
- Made in the U.S.A.

FITS MODEL

VICTORY

Vegas, Vegas 8-Ball, Kingpin, Gunner, Judge, Boardwalk, High-Ball 06-16

Hammer, Hammer S, Hammer 8-Ball, Jackpot, Vegas Jackpot 05-16

DESCRIPTION

PART

SUG. RETAIL

Chrome	1810-1996	\$629.95
Black	1810-1997	669.95
Chrome	1810-2202	659.95
Black	1810-2203	699.95

PRO STREET WITH BLACK FLUTED END CAP FOR VICTORY VEGAS 8-BALL, KINGPIN, KINGPIN 8-BALL, HIGHBALL 02-05

- Features stepped headers 1⁷/₈" into 1³/₄" for maximum performance
- Full heat shields cover the headers
- Black billet end caps with contrasting machined flutes
- Aggressive exhaust sound
- Easy installation; hardware and instructions provided
- Made in the U.S.A.



1810-2176

DESCRIPTION

PART

SUG. RETAIL

DESCRIPTION

PART

SUG. RETAIL

Chrome	1810-2176	\$729.95	Black	1810-2177	\$769.95
--------	-----------	----------	-------	-----------	----------

DISCLAIMER: NOT LEGAL FOR SALE OR USE IN CALIFORNIA ON ANY POLLUTION CONTROLLED MOTOR VEHICLES. SEE PAGE 3 FOR IMPORTANT EMISSION DEFINITIONS AND REGULATORY COMPLIANCE AND WARRANTY INFORMATION.

All part numbers in **BOLD MAGENTA** are new this year.

partsnetweb.com / dragnetweb.com

VICTORY

EXHAUST

LUGGAGE

SECURITY

WINDSHIELDS

FAIRINGS & BODY

SEATS & SISSY BARS

HANDLEBARS & HAND CONTROLS

FOOTPEGS & FOOT CONTROLS

LIGHTING

ELECTRICAL

WHEELS & ACCESSORIES

BRAKES & SUSPENSION

ENGINE

FUEL/AIR SYSTEMS

INDIAN

EXHAUST

WINDSHIELDS

FAIRINGS & BODY

SEATS & SISSY BARS

HANDLEBARS & HAND CONTROLS

FOOTPEGS & FOOT CONTROLS

LIGHTING

ELECTRICAL

WHEELS & BRAKES

SUSPENSION

ENGINE

FUEL/AIR SYSTEMS

VICTORY

EXHAUST

LUGGAGE

SECURITY

WINDSHIELDS

FAIRINGS & BODY

SEATS & SISSY BARS

HANDLEBARS & HAND CONTROLS

FOOTPEGS & FOOT CONTROLS

LIGHTING

ELECTRICAL

WHEELS & ACCESSORIES

BRAKES & SUSPENSION

ENGINE

FUEL/AIR SYSTEMS

INDIAN

EXHAUST

WINDSHIELDS

FAIRINGS & BODY

SEATS & SISSY BARS

HANDLEBARS & HAND CONTROLS

FOOTPEGS & FOOT CONTROLS

LIGHTING

ELECTRICAL

WHEELS & BRAKES

SUSPENSION

ENGINE

FUEL/AIR SYSTEMS



1811-3003



1860-0937

DNT 4" SLIP-ON MUFFLERS FOR VICTORY CROSS ROADS 10-15, CROSS COUNTRY 10-15, HARDBALL 12-15, MAGNUM 15-16

- Muffler bodies are 4" in diameter
- Features a 3-step "DNT" acoustically-tuned baffle that delivers a unique exhaust note
- Mounts to the stock muffler brackets using the OEM hardware
- Mufflers accept optional end caps (sold separately)
- Made in the U.S.A.

DESCRIPTION	PART #	SUG. RETAIL	DESCRIPTION	PART #	SUG. RETAIL
MUFFLERS			OPTIONAL END CAPS		
Chrome	1811-3002	\$799.95	Fluted chrome	1860-0937	\$199.95
Black ceramic	1811-3003	859.95	Fluted black ceramic	1860-0938	179.95



1811-2448



1811-2449

4" STRAIGHT MUFFLER SLIP-ONS WITH QUICK-CHANGE SERIES END CAPS FOR VICTORY CROSS ROADS 10-15, CROSS COUNTRY 10-15, HARDBALL 12-15, MAGNUM 15-16

- Straight 4" slip-on muffler with choice of billet aluminum quick-change end caps (sold separately)
- 16-gauge steel construction
- Removable 2 1/4" diameter baffles wrapped in woven fiberglass
- Moderately aggressive exhaust sound
- Mounts onto stock brackets and use stock hardware
- Extended end caps have 1" or 2" added length to clear saddlebag extensions
- Made in the U.S.A.



1861-0748



1861-0749

DESCRIPTION	PART #	SUG. RETAIL
MUFFLERS		
Chrome	1811-2448	\$599.95
Black	1811-2449	639.95

DESCRIPTION	PART #	SUG. RETAIL	DESCRIPTION	PART #	SUG. RETAIL
OPTIONAL QUICK-CHANGE END CAPS			OPTIONAL QUICK-CHANGE END CAPS (CONT)		
Black, fluted	1861-0746	\$139.95	Black, fluted +1	1861-0999	\$69.95
Black, bevel	1861-0747	139.95	Black, slash +1	1861-1001	69.95
Polish, slash	1861-0748 ¹	139.95	Black, fluted +2	1861-1000	69.95
Black, slash	1861-0749 ¹	139.95	Black, slash +2	1861-1002	69.95
Polish, fluted	1861-0750	139.95			

¹ Can be rotated to change direction of slash.

DISCLAIMER: NOT LEGAL FOR SALE OR USE IN CALIFORNIA ON ANY POLLUTION CONTROLLED MOTOR VEHICLES. SEE PAGE 3 FOR IMPORTANT EMISSION DEFINITIONS AND REGULATORY COMPLIANCE AND WARRANTY INFORMATION.



3" PERFORMANCE SLIP-ON MUFFLERS FOR VICTORY OCTANE 17

- 16-gauge steel construction with black finish
- 3" muffler housings and billet end caps
- Includes removable baffles, mounting hardware and instructions

SUG. RETAIL **\$499.95** PART # **1811-3186**

- VICTORY
- EXHAUST
- LUGGAGE
- SECURITY
- WINDSHIELDS
- FAIRINGS & BODY
- SEATS & SISSY BARS
- HANDLEBARS & HAND CONTROLS
- FOOTPEGS & FOOT CONTROLS
- LIGHTING
- ELECTRICAL
- WHEELS & ACCESSORIES
- BRAKES & SUSPENSION



1810-2274



2-INTO-1 HOT ROD EXHAUST SYSTEMS

- Made from high-quality seamless, mandrel-bent stainless steel
- Dyno developed and tested
- Offer a sleek look, aggressive sound and all-around performance throughout the entire powerband
- Feature full heat-shield coverage and built-in O₂ bungs
- Available in high-quality chrome or black ceramic coated finish
- Made in the U.S.A.

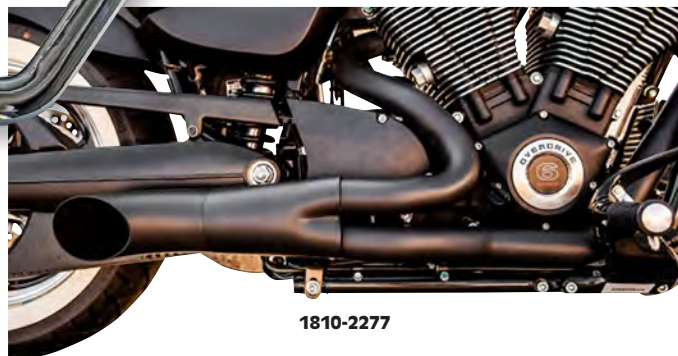

1810-2277

DESCRIPTION	PART #	SUG. RETAIL	DESCRIPTION	PART #	SUG. RETAIL
FOR VICTORY CRUISERS 06-15, VEGAS 05 W/ 100" AND 106" (INCLUDES VISION)			FOR VICTORY BAGGER/TOURING CROSS COUNTRY, HARDBALL, CROSS ROADS (COMES W/ SUPPORT BRACKETS FOR THE SADDLEBAGS)		
Chrome	1810-2274	\$918.95	Chrome	1810-2276	\$1,033.95
Black	1810-2275	918.95	Black	1810-2277	1,033.95

DISCLAIMER: NOT LEGAL FOR SALE OR USE IN CALIFORNIA ON ANY POLLUTION CONTROLLED MOTOR VEHICLES. SEE PAGE 3 FOR IMPORTANT EMISSION DEFINITIONS AND REGULATORY COMPLIANCE AND WARRANTY INFORMATION.

All part numbers in **BOLD MAGENTA** are new this year.

- INDIAN
- EXHAUST
- WINDSHIELDS
- FAIRINGS & BODY
- SEATS & SISSY BARS
- HANDLEBARS & HAND CONTROLS
- FOOTPEGS & FOOT CONTROLS
- LIGHTING
- ELECTRICAL
- WHEELS & BRAKES
- SUSPENSION
- ENGINE
- FUEL/AIR SYSTEMS

**VANCE
HINES**

VICTORY

EXHAUST

LUGGAGE

SECURITY

WINDSHIELDS

FAIRINGS
& BODY

SEATS &
SISSY BARS

HANDLEBARS &
HAND CONTROLS

FOOTPEGS &
FOOT CONTROLS

LIGHTING

ELECTRICAL

BRAKES &
SUSPENSION

ENGINE

FUEL/AIR
SYSTEMS

INDIAN

EXHAUST

WINDSHIELDS

FAIRINGS
& BODY

SEATS &
SISSY BARS

HANDLEBARS &
HAND CONTROLS

FOOTPEGS &
FOOT CONTROLS

LIGHTING

ELECTRICAL

WHEELS &
BRAKES

SUSPENSION

ENGINE

FUEL/AIR
SYSTEMS



1801-0726



1801-0727

41/2" HI-OUTPUT SLIP-ON MUFFLERS

FOR VICTORY CROSS ROADS AND CROSS COUNTRY 10-16, HARDBALL 12-16, CLASSIC 13-16

- Designed specifically to address the needs of tuned motors built for high-horsepower applications (high compression, large displacement, big cams)
- Every aspect is singularly focused to yield maximum horsepower by improving the volumetric efficiency of heavily modified engines as well as stock
- Race-quality black ceramic or chrome
- 3" perforated core baffles
- Optional quiet baffle sold separately
- Sold in pairs
- Made in the U.S.A.

DESCRIPTION	PART #	SUG. RETAIL	DESCRIPTION	PART #	SUG. RETAIL
Mufflers, chrome	1801-0726	\$729.99	Opt. quiet baffle (ea.)	1861-0606	\$49.99
Mufflers, black	1801-0727	799.99			

DISCLAIMER: NOT LEGAL FOR SALE OR USE IN CALIFORNIA ON ANY POLLUTION CONTROLLED MOTOR VEHICLES.

SEE PAGE 3 FOR IMPORTANT EMISSION DEFINITIONS AND REGULATORY COMPLIANCE AND WARRANTY INFORMATION.

partsnetweb.com / dragnetweb.com

All part numbers in **BOLD MAGENTA** are new this year.



PRO BUILDER SADDLEBAG KIT FOR VICTORY KINGPIN 06-12, VEGAS, 8-BALL 06-10

- Everything you need to build your own custom saddlebags
- Includes unpainted and unassembled lockable saddlebags, powder-coated brackets and all hardware
- Durable ABS construction
- Over 1,800 cubic inches of storage per saddlebag
- Each bag measures 9.5" W x 22" L x 12" H
- Sold in pairs
- Made in the U.S.A.

SUG. RETAIL\$499.95 PART # 3501-0745



SIXER SADDLEBAGS

- Constructed from high-temp/high-impact injection-molded ABS plastic
- A polished base-coat and clear-coat provide the best finish available
- Secure, key-lockable and weather-resistant
- Bags measure 8 1/2" W x 18 1/2" L x 12" D
- Mounting bracket kit sold separately; features machined aluminum brackets with a black finish; also included is a complete hardware kit for easy and quick mounting
- Sold in pairs
- Made in the U.S.A.

DESCRIPTION	PART #	SUG. RETAIL	DESCRIPTION	PART #	SUG. RETAIL
SIXER SADDLEBAGS			MOUNTING BRACKET KIT		
High-gloss black	3501-0825	\$589.95	For Victory Kingpin 06-12, Vegas, 8-Ball 06-10	3501-0830	\$255.95
Satin	3501-0826	499.95			

All part numbers in **BOLD MAGENTA** are new this year.

VICTORY

EXHAUST

LUGGAGE

SECURITY

WINDSHIELDS

FAIRINGS & BODY

SEATS & Sissy BARS

HANDLEBARS & HAND CONTROLS

FOOTPEGS & FOOT CONTROLS

LIGHTING

ELECTRICAL

WHEELS & ACCESSORIES

BRAKES & SUSPENSION

ENGINE

FUEL/AIR SYSTEMS

INDIAN

EXHAUST

WINDSHIELDS

FAIRINGS & BODY

SEATS & Sissy BARS

HANDLEBARS & HAND CONTROLS

FOOTPEGS & FOOT CONTROLS

LIGHTING

ELECTRICAL

WHEELS & BRAKES

SUSPENSION

ENGINE

FUEL/AIR SYSTEMS

VICTORY



EXHAUST

3501-0821

3501-0822

3501-0241

LUGGAGE



SECURITY

WINDSHIELDS

FAIRINGS & BODY

SEATS & Sissy BARS

HANDLEBARS & HAND CONTROLS

FOOTPEGS & FOOT CONTROLS

LIGHTING

ELECTRICAL

WHEELS & ACCESSORIES

BRAKES & SUSPENSION

ENGINE

FUEL/AIR SYSTEMS

INDIAN

EXHAUST

WINDSHIELDS

FAIRINGS & BODY

SEATS & Sissy BARS

HANDLEBARS & HAND CONTROLS

FOOTPEGS & FOOT CONTROLS

LIGHTING

ELECTRICAL

WHEELS & BRAKES

SUSPENSION

ENGINE

FUEL/AIR SYSTEMS

CLASSIC SADDLEBAGS

- Distinct American styling
- Durable Cycra ABS plastic
- Quality injection-molded fit and finish
- No fiberglass or resin smell to ruin your jacket or clothes
- Top-quality original equipment grade paints and specifications are used
- A polished-base coat and clear-coat provides the best finish available
- Secure, key-lockable and weather-resistant
- Bags measure 9 1/2" W x 22" L x 12" D
- Mounting bracket kit sold separately
- Mounting bracket kit features machined aluminum brackets with a black finish; also included is a complete hardware kit for easy and quick mounting
- Sold in pairs
- Made in the U.S.A.



DESCRIPTION	PART #	SUG. RETAIL
CLASSIC SADDLEBAGS		
High-gloss black	3501-0821	\$649.95
Satin	3501-0822	599.95
Unpainted w/ mount holes	3501-0241	389.95

DESCRIPTION	PART #	SUG. RETAIL
MOUNTING BRACKET KIT		
For Victory Kingpin 06-12, Vegas, 8-Ball 06-10	3501-0830	\$255.95

3501-0823



3501-0824



SLIMBAG SADDLEBAGS

- Traditional American styling will complement your bike
- Slim profile and contoured back shape fit around the shocks and swingarm
- Top-quality original equipment-grade paints and specifications are used
- A polished base-coat and clear-coat provide you with the best finish available
- Secure, key-lockable and weather resistant
- Bags measure 8 1/2" W x 22" L x 12" D
- Mounting bracket kit sold separately; features machined aluminum brackets with a black finish; also included is a complete hardware kit for easy and quick mounting
- Sold in pairs
- Made in the U.S.A.



DESCRIPTION	PART #	SUG. RETAIL
SLIMBAG SADDLEBAGS		
High-gloss black	3501-0823	\$659.95
Satin	3501-0824	549.95

DESCRIPTION	PART #	SUG. RETAIL
MOUNTING BRACKET KIT		
For Victory Kingpin 06-12, Vegas, 8-Ball 06-10	3501-0830	\$255.95



DELUXE SOLO RACK BAG

- Constructed of heavy-duty, water-resistant polyester
- Expandable, contoured bag fits most solo racks and sissy bar racks
- Expandable side pockets for extra carrying capacity
- 1617 cu. in. of lined storage space
- Quick-release side lock buckle anchoring system with belly strap
- Rain cover and shoulder strap included
- Expanded dimensions: 14" L x 16¹/₂" W x 7" H

SUG. RETAIL **\$99.95** PART # **3515-0170**



1900 SADDLEBAG LINER FOR VICTORY CROSS COUNTRY, CROSS ROADS HARD BAGS 10-16

- Made from durable polyurethane-backed polyester, these liners will not wear out and will provide excellent weather resistance to protect what is inside
- The generous 23³/₄" long compartment has a double-sided top zipper allowing quick and easy access to its 7" width for packing and unpacking
- Its sturdy 2" wide carry handles join together with a leather loop for a secure closure and effortless handling
- Liner measures a generous 23³/₄" x 12" x 7"

SUG. RETAIL **\$32.95** PART # **3501-1167**



TRUNK LINER BAG FOR VICTORY CROSS COUNTRY 10-16

- Trunk Liner Bag allows riders to fill the uniquely shaped tapered Victory trunk quickly and efficiently
- A full-length zippered top makes packing and retrieving items simple and convenient
- In addition to the generous main storage area is a separate 8" x 12" zippered compartment allowing quick access to personal items
- Measures 8" x 17.5" x 20"

SUG. RETAIL **\$29.95** PART # **3516-0215**



WINDSHIELD TRI-POUCH FOR VICTORY CROSS COUNTRY 10-16, MAGNUM 15-16

- Constructed of marine-grade vinyl
- Incorporates a large 7" x 4" clear cell phone pocket on a generous 8" x 4" x 2" center compartment
- Cell phones, MP3 players or other devices load from the inside sleeve, keeping rain out and devices dry
- Clear UV-stabilized surface allows easy screen reading and will hold up in the toughest environments
- Two end storage pouches measure 4¹/₂" x 3" x 1¹/₂" for gloves, garage door openers or more
- Hook-and-loop closure

SUG. RETAIL **\$79.95** PART # **3508-0045**



HIDE A KEY POUCH

- Made from weather-resistant, marine-grade vinyl
- Hides an extra key on your bike to keep it clean and ready to use should the need arise
- 6" hook-and-loop strap provides a secure fit that will not give way, even under the harshest conditions
- Measures 3¹/₂" L x 2¹/₄" W to fit even the largest keys
- Available in black
- Made in the U.S.A.

SUG. RETAIL **\$8.95**

PART # **3550-0273**



SADDLEBAG LID BRAS FOR VICTORY CROSS COUNTRY, CROSS ROADS MODELS W/ HARD SADDLEBAGS 10-16

- Saddlebag Lid Bras stop scratches and cover those that are already there
- Tapered design leaves the saddlebag lids artfully exposed while protecting and covering the front portion from marring
- Secured in place with hook-and-loop material to the inside top of the saddlebag lid in four locations for a secure fit
- Remove easily for cleaning and waxing

SUG. RETAIL **\$65.95** PART # **3501-1168**



VICTORY

EXHAUST

LUGGAGE

SECURITY

WINDSHIELDS

FAIRINGS & BODY

SEATS & SISSY BARS

HANDLEBARS & HAND CONTROLS

FOOTPEGS & FOOT CONTROLS

LIGHTING

ELECTRICAL

WHEELS & ACCESSORIES

BRAKES & SUSPENSION

ENGINE

FUEL/AIR SYSTEMS

INDIAN

EXHAUST

WINDSHIELDS

FAIRINGS & BODY

SEATS & SISSY BARS

HANDLEBARS & HAND CONTROLS

FOOTPEGS & FOOT CONTROLS

LIGHTING

ELECTRICAL

WHEELS & BRAKES

SUSPENSION

ENGINE

FUEL/AIR SYSTEMS

All part numbers in **BOLD MAGENTA** are new this year.

VICTORY

EXHAUST

LUGGAGE

SECURITY

WINDSHIELDS

FAIRINGS & BODY

SEATS & Sissy BARS

HANDLEBARS & HAND CONTROLS

FOOTPEGS & FOOT CONTROLS

LIGHTING

ELECTRICAL

WHEELS & ACCESSORIES

BRAKES & SUSPENSION

ENGINE

FUEL/AIR SYSTEMS

INDIAN

EXHAUST

WINDSHIELDS

FAIRINGS & BODY

SEATS & Sissy BARS

HANDLEBARS & HAND CONTROLS

FOOTPEGS & FOOT CONTROLS

LIGHTING

ELECTRICAL

WHEELS & BRAKES

SUSPENSION

ENGINE

FUEL/AIR SYSTEMS



TOP SHELF® ORGANIZER

FOR VICTORY CROSS COUNTRY 10-17 HARD SADDLEBAG

- Utilizes the stock rear bail head pin and included oversize washer to lock unit in place
- Custom molded tray only fits the right rear saddlebag
- Tray design custom-molded to Saddlebag wall shape
- Die-cut rubber grip mat included; no tools required for installation
- Made in the U.S.A.

SUG. RETAIL **\$44.95** PART # **3501-0766**



KURYAKYN



SADDLEBAG FRONT KICK ACCENTS FOR VICTORY CROSS COUNTRY, CROSS COUNTRY TOUR, MAGNUM 10-16, CROSS ROADS 10-14, HARDBALL 12-13

- Prevent those unsightly scuffs and scratches or cover up the ones that are already there
- Black inlaid rubber accent in a chrome ABS housing
- Hassle free peel-and-stick installation
- For use on models listed equipped with OEM hard bags
- Sold in pairs

SUG. RETAIL ... **\$99.99** PART # **3550-0222**



SADDLEBAG TOP ACCENTS

FOR CROSS COUNTRY/CROSS COUNTRY TOUR/MAGNUM 10-16, HARD BALL 12-13 AND CROSS ROADS 10-14 MODELS WITH HARD SADDLEBAGS

- Attach down top center of saddlebags to flawlessly enhance the bike's contours
- Mount either directly centered on top of the saddlebags or slightly to the rear to coordinate with Kuryakyn saddlebag front kick accents PART # 3550-0222; sold separately
- Simple peel-and-stick installation
- Sold in pairs

NOTE: Not compatible with OEM leather-covered bags.

SUG. RETAIL **\$79.99** PART # **3501-1165**



SADDLEBAG SIDE SWOOPS

FOR VICTORY CROSS COUNTRY/CROSS COUNTRY TOUR/MAGNUM 10-16, HARD BALL 12-13 AND CROSS ROADS 10-14 MODELS WITH SADDLEBAGS

- Dress up your Victory saddlebags and provide some scuff protection at the same time
- Simple peel-and-stick installation
- Sold in pairs

NOTE: Not compatible with OEM leather-covered bags.

SUG. RETAIL **\$79.99** PART # **3501-1164**

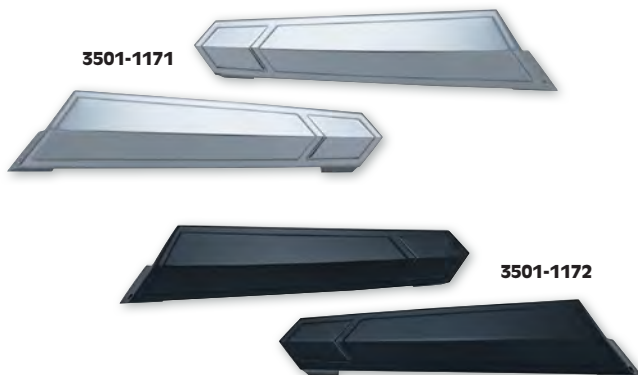

SADDLEBAG HINGES

FOR CROSS COUNTRY/CROSS COUNTRY TOUR/MAGNUM 10-16, HARD BALL 12-13, CROSS ROADS 10-14 WITH HARD SADDLEBAGS

- Direct replacement hinges are mad from die-cast aluminum
- Minimalist design is sleeker than stock to enhance the contours of the OEM bags
- Easy to install using the factory hardware
- Sold in pairs

SUG. RETAIL **\$129.99**

COLOR	PART #	COLOR	PART #
Chrome	3501-1171	Satin black	3501-1172

SCORPIO



SR-i900R RFID MOTORCYCLE SECURITY SYSTEM

- The SR-i900R is a latest-generation two-way FM security system offering hands-free RFID technology
- Simply walk towards or away from your bike, and the remote transceiver will automatically communicate an arm or disarm command using its proximity recognition system
- This unique auto-arm and hands-free disarm operation provides the highest standard of security and convenience
- Standard features include:
 - RF-ID for hands-free operation
 - Programmable auto or manual arming and disarming
 - Long-range FM transceiver (up to a 1/2 mile)
 - Range and signal status display
 - Compact design (3¹¹/₁₆" x 2³/₄" x 7/₈"")
 - Dual-axis accelerometer for detecting impact/inclination
 - Built-in 120 dB multi-tone siren with soft chirp
 - Sensor violation display
 - Audible/vibrating alert
 - Remote motorcycle finder/panic alarm
- Programmable perimeter sensor with warn away that detects motion around the bike, protecting saddlebags, luggage and accessories
- Built-in battery backup system allows the pager to operate even if wires are cut or circumvented
- Ignition disable feature allows the user to remotely cut off the engine in case of hijack
- Includes charging cord for remote receiver
- Factory connector kits allow the alarm system to be integrated into the OEM-style harness without any cutting or splicing (sold separately; see page 18)

NOTE: Includes module, mounting kit and hardwire kit (not shown).

SUG. RETAIL **\$439.95** PART # 4020-0052



SR-i900 RFID/TWO-WAY FM SECURITY SYSTEM

- SR-i900 provides the convenience of hands-free operation combined with a compact two-way FM paging security system designed specifically for the motorcycle industry
- Standard features include two-way FM remote transceiver
- RFID for hands-free operation
- Auto or manual arming and disarming
- Ignition circuit sensor
- Long-range FM transceiver (up to a 1/2 mile)
- Range and signal status display
- Compact design (3¹¹/₁₆" x 2³/₄" x 7/₈"")
- Dual-axis accelerometer for detecting impact/inclination
- Built-in 120 dB multi-tone siren with soft chirp
- Sensor violation display
- Audible/vibrating alert
- Smart Battery Safeguard with sleep mode
- Motorcycle battery voltage display
- Remote motorcycle finder/panic alarm
- Includes charging cord for remote receiver
- Optional programmable multi-stage perimeter sensor detects motion around the motorcycle (sold separately; PART #SN-4)
- Optional ignition disable/anti-hijack allows disabling of the motorcycle's electrical system and prevents "hot wiring" (sold separately; PART #4020-0007)
- Optional Factory Connector Kits: The SR-i900 system is universal and will install on any motorcycle; optional OEM-compatible factory connector kits are model-specific and plug directly into the factory harness making installation fast, clean and easy (sold separately; see page 18)

SUG. RETAIL **\$329.95** PART # 4020-0077

All part numbers in **BOLD MAGENTA** are new this year.

VICTORY

EXHAUST

LUGGAGE

SECURITY

WINDSHIELDS

FAIRINGS & BODY

SEATS & Sissy BARS

HANDLEBARS & HAND CONTROLS

FOOTPEGS & FOOT CONTROLS

LIGHTING

ELECTRICAL

WHEELS & ACCESSORIES

BRAKES & SUSPENSION

ENGINE

FUEL/AIR SYSTEMS

INDIAN

EXHAUST

WINDSHIELDS

FAIRINGS & BODY

SEATS & Sissy BARS

HANDLEBARS & HAND CONTROLS

FOOTPEGS & FOOT CONTROLS

LIGHTING

ELECTRICAL

WHEELS & BRAKES

SUSPENSION

ENGINE

FUEL/AIR SYSTEMS

VICTORY

EXHAUST

LUGGAGE

SECURITY

WINDSHIELDS

FAIRINGS & BODY

SEATS & Sissy BARS

HANDLEBARS & HAND CONTROLS

FOOTPEGS & FOOT CONTROLS

LIGHTING

ELECTRICAL

WHEELS & ACCESSORIES

BRAKES & SUSPENSION

ENGINE

FUEL/AIR SYSTEMS

INDIAN

EXHAUST

WINDSHIELDS

FAIRINGS & BODY

SEATS & Sissy BARS

HANDLEBARS & HAND CONTROLS

FOOTPEGS & FOOT CONTROLS

LIGHTING

ELECTRICAL

WHEELS & BRAKES

SUSPENSION

ENGINE

FUEL/AIR SYSTEMS

SCORPIO



SR-i800S RFID MOTORCYCLE SECURITY SYSTEM

- Easy-to-use system provides the convenience of hands-free operation and the security of shock, tilt and ignition sensors
- RFID hands-free technology eliminates reaching for the remote to protect the motorcycle
- Standard features include single-button, waterproof remote transceiver
- RFID for hands-free operation
- Auto or manual arming and disarming
- Soft chirp arming
- Flashing lights with trigger memory display
- Ignition circuit sensor
- Compact design (3¹¹/₁₆" x 2³/₄" x 7⁷/₈")
- Dual-axis accelerometer for detecting impact/inclination
- Built-in 120 dB multi-tone siren with soft chirp
- Sensor violation display
- Smart Battery Safeguard with sleep mode
- Remote motorcycle finder/panic alarm
- Built-in battery backup system allows the siren to operate even if wires are cut or circumvented
- Optional programmable multi-stage perimeter sensor detects motion around the motorcycle (sold separately; PART #SN-4)
- Optional ignition disable allows disabling of the motorcycle's electrical system and prevents "hot wiring" (sold separately; PART #4020-0007)
- Optional Factory Connector Kits: The SR-i800S is universal and will install on any motorcycle; optional OEM-compatible factory connector kits are model-specific and plug directly into the factory harness, making installation fast, clean and easy (sold separately; see below)

SUG. RETAIL \$149.95 PART # 4020-0076

ALARM ACCESSORIES

- Programmable perimeter sensor with warn-away detects motion around the bike, protecting saddlebags, luggage and accessories; built-in battery backup system allows the pager to operate even if wires are cut or circumvented
- Ignition disable allows the user to remotely cut off the engine in case of a hijack



DESCRIPTION

Ignition disabler/anti-hijack kit for PART #s 4020-0076, 4020-0077
 Perimeter sensor for PART #s 4020-0076, 4020-0077

PART #	SUG. RETAIL
4020-0007	\$29.95
SN-4	49.95

4020-0068

4020-0057



FACTORY CONNECTOR KITS

- Allow all Scorpio alarms to be integrated into the OEM-style harness without any cutting or splicing

FITS MODEL	PART #	SUG. RETAIL
VICTORY		
All models 05-08 (except Vision)	4020-0033	\$25.95
All models 09-10 (except Vision)	4020-0068	24.95
Vision 08-09	4020-0057	29.95

All part numbers in **BOLD MAGENTA** are new this year.



MEMPHIS FATS

- Feature traditional American styling with gradient translucent shading in vibrant colors, as well as clear and solar (a light tint with 72% visible light transmission)
- Made from Lucite® for excellent optics and durability
- 22" W with five standard heights to choose from
- Windshield straps are available in polished stainless steel with CNC-machined billet aluminum fittings and stainless steel socket-head screws or "Night Shades" black version, which is a gradient black windshield with black E-coated stainless steel straps, fittings and hardware for a black-on-black sinister look
- Available with a 9" headlight cutout
- Mounting hardware must be ordered separately; see page 21
- Optional Lowers available for additional coverage; see page 23
- Made in the U.S.A.

15"/17"

SUG. RETAIL \$185.95

COLOR	PART #	DESCRIPTION	PART #
Clear	2313-0073	Clear	MEM3620
Gradient black	2313-0074	Gradient black	MEM3621
Gradient ruby	2313-0075	Gradient ruby	MEM3622
Gradient blue	2313-0079	Gradient blue	MEM3626
Gradient burnt orange	2313-0080	Gradient burnt orange	2313-0016
Solar	2313-0081	Solar	MEM3629
"Night Shades" black	2313-0100	"Night Shades" black	2313-0101

19"

SUG. RETAIL \$195.95

DESCRIPTION	PART #
Clear	MEM3710
Gradient black	MEM3711
Gradient ruby	MEM3712
Gradient blue	MEM3716
Gradient burnt orange	2313-0017
Solar	MEM3719
"Night Shades" black	2313-0102

21"

SUG. RETAIL \$206.95

DESCRIPTION	PART #
Clear	MEM3810
Gradient black	MEM3811
Gradient ruby	MEM3812
Gradient blue	MEM3816
Gradient burnt orange	2313-0018
Solar	MEM3819
"Night Shades" black	2313-0103

All part numbers in **BOLD MAGENTA** are new this year.

VICTORY

EXHAUST

LUGGAGE

SECURITY

WINDSHIELDS

FAIRINGS & BODY

SEATS & Sissy BARS

HANDLEBARS & HAND CONTROLS

FOOTPEGS & FOOT CONTROLS

LIGHTING

ELECTRICAL

WHEELS & ACCESSORIES

BRAKES & SUSPENSION

ENGINE

FUEL/AIR SYSTEMS

INDIAN

EXHAUST

WINDSHIELDS

FAIRINGS & BODY

SEATS & Sissy BARS

HANDLEBARS & HAND CONTROLS

FOOTPEGS & FOOT CONTROLS

LIGHTING

ELECTRICAL

WHEELS & BRAKES

SUSPENSION

ENGINE

FUEL/AIR SYSTEMS



Position 1



Position 2

Position 3

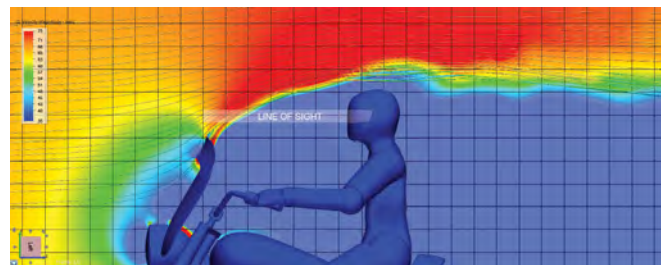

DROP TOP™ MEMPHIS FATS

- A revolutionary concept: the windshield is out of your line of sight, but the air goes over your head- with no buffeting
- Adjustable and available in three height ranges: 13"-16", 15"-18" and 17"-20"
- Contoured concave Venturi Wing™ boosts the airflow up an additional 3", through the full range of adjustment
- Wings can be installed in three positions, each with 1 1/4" of no-tool adjustment, allowing riders to find the sweet spot for cruising down the highway, or "drop top" around town
- Dynamic styling, available in ghost or black smoke with polished or "night shades" black stainless straps
- Engineered using CFD (Computational Fluid Dynamics) software
- Available in 7" or 9" headlight cutout
- Mounting hardware must be ordered separately; see page 21
- Made in the U.S.A.

DROP TOP MEMPHIS FATS WINDSHIELD SIZING PROCEDURE

- Using a Memphis Shades sizing guide held about "one finger" above the headlight, slanted back about the same angle of the forks, sight level through the sizing guide to the tip of the rider's nose
- The closest height shown on the sizing guide is the rider's normal windshield height
- For Drop Top sizing, subtract 2" from the rider's normal windshield height and find the Drop Top range into which the shorter height fits (For example, if you measure 19" on the sizing guide, subtract 2" to get 17"; your Drop Top Memphis Fats size is 15"-18")

NORMAL WINDSHIELD HEIGHT

DROP TOP™ HEIGHT RANGE

- 17" - 20" DROP TOP™
- 15" - 18" DROP TOP™
- 13" - 16" DROP TOP™

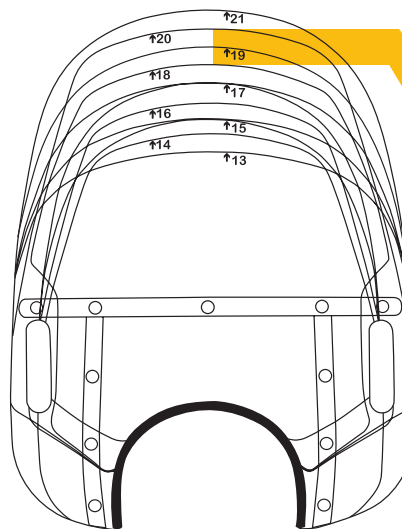

Normal Size	Drop Top Range
21"	17"-20"
20"	15"-18"
19"	13"-16"
18"	
17"	
16"	
15"	
14"	
13"	

DESCRIPTION	7" CUT OUT	9" CUT OUT	SUG. RETAIL
13"-16"			
Ghost	2313-0152	2313-0158	\$255.95
Black smoke	2313-0155	2313-0161	255.95
"Night Shades" ghost	2313-0164	2313-0170	255.95
"Night Shades" black smoke	2313-0167	2313-0173	255.95
15"-18"			
Ghost	2313-0153	2313-0159	255.95
Black smoke	2313-0156	2313-0162	255.95

DESCRIPTION	7" CUT OUT	9" CUT OUT	SUG. RETAIL
15"-18" (CONT)			
"Night Shades" ghost	2313-0165	2313-0171	\$255.95
"Night Shades" black smoke	2313-0168	2313-0174	255.95
17"-20"			
Ghost	2313-0154	2313-0160	265.95
Black smoke	2313-0157	2313-0163	265.95
"Night Shades" ghost	2313-0166	2313-0172	265.95
"Night Shades" black smoke	2313-0169	2313-0175	265.95

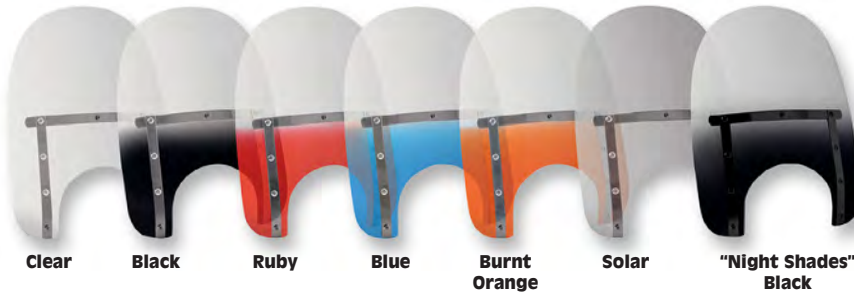

MEM4121



MEMPHIS SLIM

- Slimmed-down version of Memphis Fats
- Gradient translucent colors, as well as clear and solar (a light tint with 72% visible light transmission)
- Measures 18" wide; available in 15" and 17" heights with a 9" headlight cutout
- Made of Lucite® for excellent optics and durability
- Windshield straps are available in polished stainless steel with CNC-machined billet aluminum fittings and stainless steel socket-head screws or "Night Shades" black version, which is a gradient black windshield with black E-coated stainless steel straps, fittings and hardware for a black-on-black sinister look
- Mounting hardware must be ordered separately; see page 21
- Optional Lowers available for additional windshield coverage; see page 23
- Made in the U.S.A.

15"

17"

SUG. RETAIL \$167.95

SUG. RETAIL \$177.95

DESCRIPTION	PART #	DESCRIPTION	PART #
Clear	MEM4120	Gradient burnt orange	2313-0021
Gradient black	MEM4121	Solar	MEM4129
Gradient ruby	MEM4122	"Night Shades" black	2313-0105
Gradient blue	MEM4126		

DESCRIPTION	PART #	DESCRIPTION	PART #
Clear	MEM4220	Gradient burnt orange	2313-0022
Gradient black	MEM4221	Solar	MEM4229
Gradient ruby	MEM4222	"Night Shades" black	2313-0107
Gradient blue	MEM4226		



NO-TOOL TRIGGER-LOCK MOUNT KITS FOR SPORTSHIELDS

2321-0022

Trigger-Lock Mounts let you remove or change Memphis Shades Fats/Slim in a moment's time

- The revolutionary No-Tool Trigger-Lock mounting kits feature a detach system that allows you to quickly and easily remove or swap out your Sportshield without the use of any tools
- A pair of latches lock the windshield down until the spring loaded "trigger locks" are intentionally disengaged, allowing the rider to remove the windshield
- Kits are a combination of CNC-machined aluminum plates and anchors, stainless steel hardware, gray polymer bushings and glass-filled nylon latches or "Night Shades" black version which is a gradient black windshield with black E-coated stainless steel straps, fittings and hardware for a black-on-black sinister look
- Kits are custom-fit to each style of bike for no-hassle installation

PLATE-ONLY HARDWARE KITS

- Allow changing from Fats/Slim to Sportshield or from Sportshield to Fats/Slim without purchasing the entire mounting hardware

INDEPENDENT LOWERS HARDWARE

- Mounts Memphis Shades Lowers plastic to most motorcycles
- Each kit contains two fork clamp/mounting assemblies and all necessary hardware to mount Lowers plastic
- Kits can be used with select Memphis Shades windshields and several OEM windshields
- Sold in pairs; must order Lowers plastic separately

QUICK-CHANGE MOUNT KITS

LOWERS HARDWARE

PLATE-ONLY HARDWARE KITS

SUG. RETAIL \$149.95

SUG. RETAIL \$56.95

SUG. RETAIL \$65.95

FATS/SLIM MOUNT KITS

SPORTSHIELD MOUNTING KITS

FITS MODEL	FATS/SLIM MOUNT KITS		PLATE-ONLY KITS		FATS/SLIM LOWERS HARDWARE
	POLISHED	BLACK	POLISHED	KITS BLACK	
VICTORY					
Hammer 05-11'	2321-0387	2321-0389	2321-0388	2321-0390	MEM9890
Hammer S 07-12'	2321-0387	2321-0389	2321-0388	2321-0390	MEM9890
Hammer 8-Ball 10-15'	2321-0387	2321-0389	2321-0388	2321-0390	MEM9890
Kingpin 04-12'	2321-0387	2321-0389	2321-0388	2321-0390	MEM9890
Kingpin 8-Ball 08-14'	2321-0387	2321-0389	2321-0388	2321-0390	MEM9890
Vegas 04-12'	2321-0379	2321-0381	2321-0380	2321-0382	2321-0022
Vegas 8-Ball 05-14'	2321-0379	2321-0381	2321-0380	2321-0382	2321-0022
Jackpot 06-14'	2321-0379	2321-0381	2321-0380	2321-0382	2321-0022

FITS MODEL	SPORTSHIELD MOUNT KITS		PLATE-ONLY KITS	
	POLISHED	BLACK	KITS POLISHED	KITS BLACK
VICTORY				
Hammer 05-11'	2321-0383	2321-0385	2321-0384	2321-0386
Hammer 07-12'	2321-0383	2321-0385	2321-0384	2321-0386
Hammer 8-Ball 10-15'	2321-0383	2321-0385	2321-0384	2321-0386
Kingpin 04-12'	2321-0383	2321-0385	2321-0384	2321-0386
Kingpin 8-Ball 08-14'	2321-0383	2321-0385	2321-0384	2321-0386
Vegas 04-12'	2321-0375	2321-0377	2321-0376	2321-0378
Vegas 8-Ball 05-15'	2321-0375	2321-0377	2321-0376	2321-0378
Jackpot 06-14'	2321-0375	2321-0377	2321-0376	2321-0378

¹ Must use windshield with 9" headlight cutout.

¹ Must use windshield with 9" headlight cutout.

All part numbers in **BOLD MAGENTA** are new this year.

VICTORY

EXHAUST

LUGGAGE

SECURITY

WINDSHIELDS

FAIRINGS & BODY

SEATS & Sissy BARS

HANDLEBARS & HAND CONTROLS

FOOTPEGS & FOOT CONTROLS

LIGHTING

ELECTRICAL

WHEELS & ACCESSORIES

BRAKES & SUSPENSION

ENGINE

FUEL/AIR SYSTEMS

INDIAN

EXHAUST

WINDSHIELDS

FAIRINGS & BODY

SEATS & Sissy BARS

HANDLEBARS & HAND CONTROLS

FOOTPEGS & FOOT CONTROLS

LIGHTING

ELECTRICAL

WHEELS & BRAKES

SUSPENSION

ENGINE

FUEL/AIR SYSTEMS

VICTORY

EXHAUST

LUGGAGE

SECURITY

WINDSHIELDS

FAIRINGS & BODY

SEATS & SISSY BARS

HANDLEBARS & HAND CONTROLS

FOOTPEGS & FOOT CONTROLS

LIGHTING

ELECTRICAL

WHEELS & ACCESSORIES

BRAKES & SUSPENSION

ENGINE

FUEL/AIR SYSTEMS

INDIAN

EXHAUST

WINDSHIELDS

FAIRINGS & BODY

SEATS & SISSY BARS

HANDLEBARS & HAND CONTROLS

FOOTPEGS & FOOT CONTROLS

LIGHTING

ELECTRICAL

WHEELS & BRAKES

SUSPENSION

ENGINE

FUEL/AIR SYSTEMS

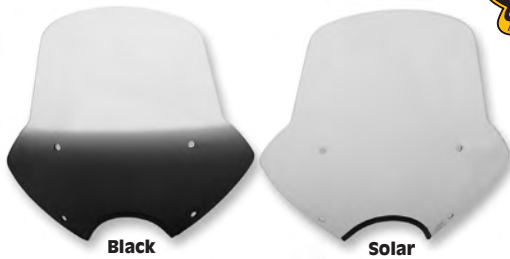

Black

Solar

SPEED DEMON

- Offers more protection with a sporty look
- Features a similar shape and style to the popular handlebar mount "Demon" shield, but with the benefits of easier installation and faster removal due to the exclusive Sportshield mounting system
- Measures 21" W and 18" H above the headlight; fits a 7" or 9" headlight cutout
- Made of Lucite® for excellent optics and durability
- No-Tool detachable Trigger-Lock mounting hardware must be ordered separately; available in polished or "Night Shades" black; see page 21
- Made in the U.S.A.



2313-0090

SUG. RETAIL \$96.95

COLOR	PART #	COLOR	PART #
Black	2313-0090	Solar	2313-0091



Black

Ruby

Blue

Burnt Orange

Solar

BIG SHOT SPORTSHIELDS

- The biggest Sportshield available
- Sleek styling with maximum coverage
- Measure 21" W x 20" H above the headlight
- Available for 9" headlights
- Made of Lucite® for excellent optics and durability
- Come in four gradient colors and solar tint
- Custom fit, model-specific mounting kits are sold separately; see page 21
- Custom Loweres available for added coverage; see page 23



MEP5729

SUG. RETAIL \$95.95

COLOR	PART #	COLOR	PART #	COLOR	PART #
Gradient black	MEP5721	Gradient blue	MEP5726	Solar	MEP5729
Gradient ruby	MEP5722	Gradient burnt orange	2313-0028		



Black

Ruby

Blue

Burnt Orange

Solar

ALLEY CAT SPORTSHIELDS

- Modeled after the popular Hell Cat handlebar-mounted windshield
- Measure 20" W x 18" H above the headlight
- Available for 9" headlights
- Made of Lucite® for excellent optics and durability
- Come in four gradient colors and solar tint
- Custom fit, model-specific mounting kits are sold separately; see page 21
- Custom Loweres available for added coverage; see page 23



MEP5621

SUG. RETAIL \$95.95

COLOR	PART #	COLOR	PART #	COLOR	PART #
Gradient black	MEP5621	Gradient blue	MEP5626	Solar	MEP5629
Gradient ruby	MEP5622	Gradient burnt orange	2313-0027		



VICTORY

EXHAUST

LUGGAGE

SECURITY

WINDSHIELDS

FAIRINGS & BODY

SEATS & Sissy BARS

HANDLEBARS & HAND CONTROLS

FOOTPEGS & FOOT CONTROLS

LIGHTING

ELECTRICAL

WHEELS & ACCESSORIES

BRAKES & SUSPENSION

ENGINE

FUEL/AIR SYSTEMS

INDIAN

EXHAUST

WINDSHIELDS

FAIRINGS & BODY

SEATS & Sissy BARS

HANDLEBARS & HAND CONTROLS

FOOTPEGS & FOOT CONTROLS

LIGHTING

ELECTRICAL

WHEELS & BRAKES

SUSPENSION

ENGINE

FUEL/AIR SYSTEMS



MEP552



Black Ruby Blue Burnt Orange Solar

POP TOP SPORTSHIELD

- Two inches taller than the handlebar-mounted Shooter windshield
- Measures 18" W x 16" H above headlight
- Available for 9" headlights
- Made of Lucite® for excellent optics and durability
- Comes in four gradient colors and solar tint
- Custom fit, model-specific mounting kits are sold separately; see page 21
- Custom Lowers available for added coverage; see below

SUG. RETAIL **\$85.95**

COLOR	PART #	COLOR	PART #	COLOR	PART #
Gradient black	MEP5521	Gradient blue	MEP5526	Solar	MEP5529
Gradient ruby	MEP5522	Gradient burnt orange	2313-0026		



MEP5810



Clear Black Ruby Blue Solar

CUSTOM LOWERS PLASTIC

- Lowers work with Sportshields as well as Memphis Fats and Slim
- Extend coverage downward to shield rider from rain, wind and noise coming up from the road
- Made of the same high-quality materials as Memphis Shades windshields with matching tints
- Must purchase Lowers mounting hardware separately; see page 21
- Sold in pairs

SUG. RETAIL **\$24.95**

COLOR	PART #	COLOR	PART #	COLOR	PART #
Clear	MEP5810	Gradient ruby	MEP5812	Solar	MEP5819
Gradient black	MEP5811	Gradient blue	MEP5816		



MEP5812

All part numbers in **BOLD MAGENTA** are new this year.

VICTORY

EXHAUST

LUGGAGE

SECURITY

WINDSHIELDS

FAIRINGS & BODY

SEATS & SISSY BARS

HANDLEBARS & HAND CONTROLS

FOOTPEGS & FOOT CONTROLS

LIGHTING

ELECTRICAL

WHEELS & ACCESSORIES

BRAKES & SUSPENSION

ENGINE

FUEL/AIR SYSTEMS

INDIAN

EXHAUST

WINDSHIELDS

FAIRINGS & BODY

SEATS & SISSY BARS

HANDLEBARS & HAND CONTROLS

FOOTPEGS & FOOT CONTROLS

LIGHTING

ELECTRICAL

WHEELS & BRAKES

SUSPENSION

ENGINE

FUEL/AIR SYSTEMS

2312-0203



BAGGERSHIELD™

FOR VICTORY CROSS COUNTRY 11-16

- DOT-approved adjustable-height windshield
 - Eliminates the need to own multiple windshields
 - Adjusts in seconds without the use of tools
 - Made from 3/16" aircraft-quality Lucite® acrylic
 - .052" thicker than OEM windshield
 - Bottom windshield color, dark smoke; top windshield color, clear
- NOTE: Measurement is taken in the center of the shield from bottom to top.**

DESCRIPTION

VICTORY

Height adjustable from 8"-14"
Height adjustable from 12"-18"

PART

2312-0203
2312-0236

SUG. RETAIL

\$177.95
203.95



2312-0270



2312-0271



2312-0272



2312-0340

AIRMASTER® 10" GRAPHIC WINDSHIELDS

FOR VICTORY CROSS COUNTRY/CROSS COUNTRY TOUR/MAGNUM 10-16

- Custom-formed from premium materials using a proprietary process
- Quality, hard-coated polycarbonate that will not crack or shatter upon impact, unlike acrylic
- Screen-printed with proprietary ink, making the images unbelievably sharp and durable
- Center air scoop has been enlarged to reduce turbulent airflow and match the sharp lines of the fairing
- Available in dark smoke or light smoke with graphics
- Graphics are printed behind a light smoke material and fill the bottom portion of the windshield, leaving the top clear for an unobstructed view

DESCRIPTION

Catacomb
Zombie

PART

2312-0270
2312-0271

SUG. RETAIL

\$169.99
169.99

DESCRIPTION

Tribal
Dark smoke

PART

2312-0272
2312-0340

SUG. RETAIL

\$169.99
149.99



2350-0354

2350-0355



WINDSHIELD ACCENTS

FOR VICTORY CROSS COUNTRY/CROSS COUNTRY TOUR/MAGNUM 10-16

- Finish off the transition from fairing to windshield
- Chrome-plated ABS construction
- Simple peel-and-stick installation

DESCRIPTION

Center trim (ea.)

PART

2350-0354

SUG. RETAIL

\$69.99

DESCRIPTION

Side trim (pr.)

PART

2350-0355

SUG. RETAIL

\$35.99



2330-0023



VICTORY

EXHAUST

LUGGAGE

SECURITY

WINDSHIELDS

FAIRINGS & BODY

SEATS & Sissy BARS

HANDLEBARS & HAND CONTROLS

FOOTPEGS & FOOT CONTROLS

LIGHTING

ELECTRICAL

WHEELS & ACCESSORIES

BRAKES & SUSPENSION

ENGINE

FUEL/AIR SYSTEMS

INDIAN

EXHAUST

WINDSHIELDS

FAIRINGS & BODY

SEATS & Sissy BARS

HANDLEBARS & HAND CONTROLS

FOOTPEGS & FOOT CONTROLS

LIGHTING

ELECTRICAL

WHEELS & BRAKES

SUSPENSION

ENGINE

FUEL/AIR SYSTEMS

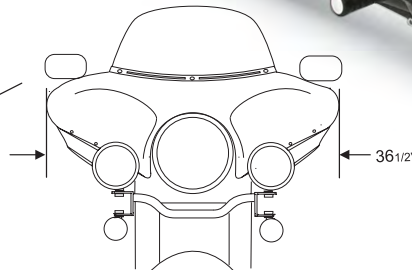
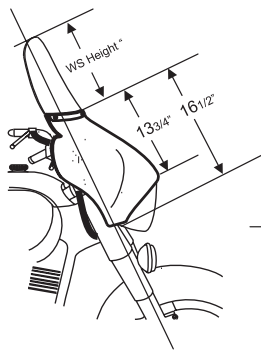

MEMPHIS SHADES BATWING FAIRING

- Features clean aerodynamic shape
- Inner fairing structure is black ABS
- Fairing outer shell is opaque black Lucite with a class A finish that looks great as is, or can easily be painted
- Memphis Shades exclusive No-Tool Trigger-Lock mounting kits feature a detach system that allows you to quickly and easily remove or install your fairing, or swap out with other Memphis Shades windshields, sportshields or fairings
- Trigger-Lock kits are available in a combination of CNC-machined aluminum plates, stainless steel bolts and aluminum anchors or black E-coated plates, bolts and anchors for a clean appearance that's built to last
- Fairing is predrilled and fitted with push-out hole plugs for easy wind deflector installation
- Windshields are available in four height and several translucent color options, as well as clear and solar (a light tint with 72% visible light transmission) for Spoiler windshields; see page 27
- Optional wind deflectors for increased downward airflow, windshield tri-pouch for storage and fairing trim for style are also available; see page 26
- Made in the U.S.A.

NOTE: Batwing Fairing is not compatible with any other fairing windshields, wind deflectors or accessories.
NOTE: Plate-only kits are for riders who already have a Memphis Shades Trigger-Lock windshield installed and do not need the anchoring hardware components.

WHAT TO ORDER

1. Batwing Fairing
2. Trigger-Lock Mount Kit
3. Windshield of your preference; height and color options are shown on next page, see page ??? for Spoiler windshields



Trigger-Lock Mounts let you remove your Batwing Fairings in a moment's time or quickly change to your Memphis Shades Fats/ Slim or Sportshield to instantly change the look of your bike.

BATWING FAIRING

SUG. RETAIL **\$299.95**

TRIGGER-LOCK MOUNT KITS

SUG. RETAIL **\$149.95**

BATWING FAIRING

FITS MODEL	BATWING FAIRING	TRIGGER-LOCK MOUNT KIT POLISHED	TRIGGER-LOCK MOUNT KIT BLACK
VICTORY			
Hammer 05-11	2330-0023	2321-0159	2321-0160
Hammer S 07-12	2330-0023	2321-0159	2321-0160
Hammer 8-Ball 10-14	2330-0023	2321-0159	2321-0160
Kingpin 04-12	2330-0023	2321-0159	2321-0160
Kingpin 8-Ball 08-14	2330-0023	2321-0159	2321-0160
Vegas 04-12	2330-0023	2321-0161	2321-0162
Vegas 8-Ball 05-14	2330-0023	2321-0161	2321-0162
Jackpot 06-14	2330-0023	2321-0161	2321-0162



2321-0160

All part numbers in **BOLD MAGENTA** are new this year.

VICTORY

EXHAUST

LUGGAGE

SECURITY

WINDSHIELDS

FAIRINGS & BODY

SEATS & Sissy BARS

HANDLEBARS & HAND CONTROLS

FOOTPEGS & FOOT CONTROLS

LIGHTING

ELECTRICAL

WHEELS & ACCESSORIES

BRAKES & SUSPENSION

ENGINE

FUEL/AIR SYSTEMS

INDIAN

EXHAUST

WINDSHIELDS

FAIRINGS & BODY

SEATS & Sissy BARS

HANDLEBARS & HAND CONTROLS

FOOTPEGS & FOOT CONTROLS

LIGHTING

ELECTRICAL

WHEELS & BRAKES

SUSPENSION

ENGINE

FUEL/AIR SYSTEMS

BATWING FAIRING, WINDSHIELDS, DEFLECTORS AND ACCESSORIES



- Windshields specific to the Batwing Fairing provide superior optics and Lucite® construction
- Available in four height and seven translucent color options, as well as clear and solar (a light tint with 72% visible light transmission)
- 5" windshields are solid translucent while 7", 9" and 12" windshields are gradient translucent
- Optional solid translucent color wind deflectors are available to extend the lower fairing surface for smooth downward airflow
- See page 27 for Spoiler windshields
- Also available is a windshield tri-pouch for storage and decorative trims for style

5" windshield
2310-0269

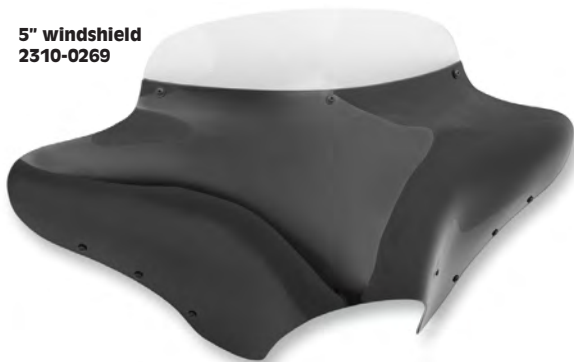

Solid colors available in 5"

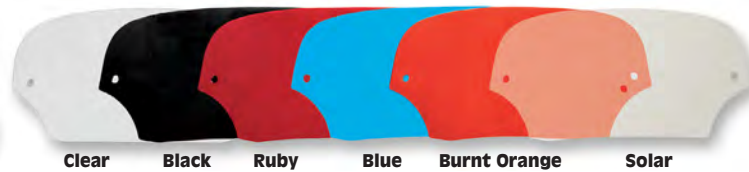

Clear, solar and gradient colors available in 7", 9" and 12"

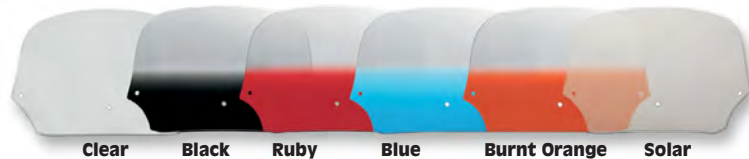

WINDSHIELDS

SUG. RETAIL \$84.95

DESCRIPTION	PART #
5" WINDSHIELDS	
Black	2310-0215
Ruby	2310-0227
Blue	2310-0231
Burnt orange	2310-0232
Clear	2310-0269
Solar	2310-0304

DESCRIPTION	PART #
7" WINDSHIELDS	
Gradient black	2310-0216
Gradient ruby	2310-0233
Gradient blue	2310-0237
Gradient burnt orange	2310-0238
Clear	2310-0270
Solar	2310-0305

WINDSHIELDS

DESCRIPTION	PART #
9" WINDSHIELDS	
Gradient black	2310-0217
Gradient ruby	2310-0239
Gradient blue	2310-0243
Gradient burnt orange	2310-0244
Clear	2310-0271
Solar	2310-0306

DESCRIPTION	PART #
12" WINDSHIELDS	
Gradient black	2310-0308
Gradient ruby	2310-0309
Gradient blue	2310-0313
Gradient burnt orange	2310-0314
Clear	2310-0307
Solar	2310-0315



2350-0111

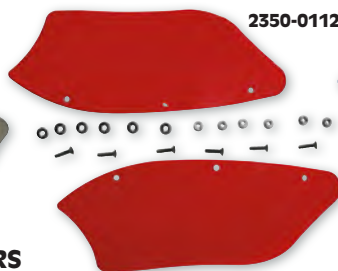

2350-0112

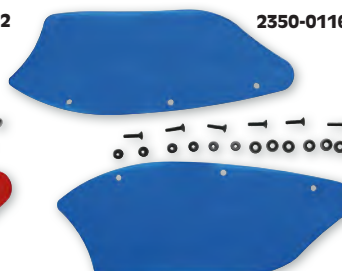

2350-0116

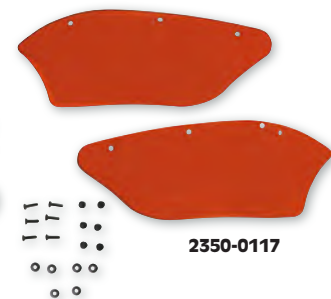

2350-0117

WIND DEFLECTORS

SUG. RETAIL \$24.95

DESCRIPTION	PART #
Black	2350-0111

DESCRIPTION	PART #
Ruby	2350-0112

DESCRIPTION	PART #
Blue	2350-0116

DESCRIPTION	PART #
Burnt orange	2350-0117

WIND DEFLECTORS



2350-0152



2350-0153



2350-0110



2350-0119



2350-0128



2350-0134

3508-0017



3508-0020

ACCESSORIES

DESCRIPTION	PART #	SUG. RETAIL
"Night Shades" cut fairing trim; Dots	2350-0152	\$59.95
"Night Shades" cut fairing trim; Ellipse	2350-0153	59.95
Polished stainless steel fairing trim; slotted fat-style	2350-0110	49.95
Polished stainless steel fairing trim; solid fat-style	2350-0119	49.95

DESCRIPTION	PART #	SUG. RETAIL
Polished stainless steel fairing trim; solid slim-style	2350-0128	\$49.95
Polished stainless steel fairing trim; slotted slim-style	2350-0134	49.95
Windshield single pouch	3508-0017	59.95
Big Zipper quad pouch for Batwing Fairings and windshield	3508-0020	89.95



2350-0135



BATWING FAIRING SPOILER WINDSHIELDS FOR MEMPHIS SHADES BATWING FAIRINGS

- Designed to be looked over, the spoiler windshield diffuses the air stream, effectively slowing the flow without buffeting
- Fit all Memphis Shades Batwing Fairings
- Made of Lucite® for superior optics and durability
- Made in the U.S.A.

SUG. RETAIL \$99.95

COLOR	5"	6.5"	9"
Smoke	2350-0167	2350-0135	2350-0170
Ghost	2350-0168	2350-0165	2350-0171
Solar	2350-0169	2350-0166	2350-0172

SIDE WINGS

- Expand comfort pocket, channeling air outward while "cleaning" the flow
- Adjust to suit rider preference
- Can be installed/removed with windshield intact - Santoprene pads grip the windshield but do not mar the surface
- "Ghost" shade - a neutral tint with 85% light transmission; barely noticeable, with just enough tint to make the edges disappear
- Fats Side Wings (PART #2350-0142) attach to any Memphis Fats windshield using CNC machined billet aluminum clamps - black E-coated; can be mounted along the Booster Wing
- Side Wings (PART #2350-0200) fit all Memphis Fats windshields or similar windshields that measure either 3mm or 4.5mm thick (includes inserts for both sizes); feature injection-molded glass-filled nylon clamps in place of the billet aluminum; can be mounted along with Hot Wing
- Made in the U.S.A.



2350-0142



2350-0200

DESCRIPTION	PART #	SUG. RETAIL	DESCRIPTION	PART #	SUG. RETAIL
Fats Side Wings	2350-0142	\$159.95	Side Wings	2350-0200	\$99.95

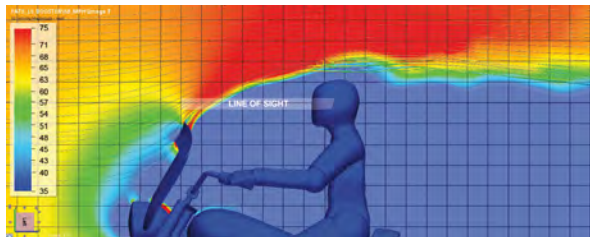

BOOSTER WING AND HOT WING

- Boost airstream upward - Venturi action speeds up the airstream while smoothing the flow - without buffeting
- Allows the use of a shorter shield; now easily look over your shield
- Both are made with "Ghost" shade - a neutral tint with 85% light transmission; barely noticeable, with just enough tint to make the edges disappear
- Booster Wing (PART #2350-0139) attaches to any Memphis Fats windshield using CNC-machined aluminum clamps; black E-coated
- Hot Wing (PART #2350-0199) (lighter and less expensive) uses injection-molded glass-filled nylon clamps in place of the original billet aluminum clamps; fits Memphis Fats windshields or similar windshields that measure 3mm or 4.5mm thick (includes inserts for both sizes)
- Made in the U.S.A.



2350-0139



2350-0199

DESCRIPTION	PART #	SUG. RETAIL	DESCRIPTION	PART #	SUG. RETAIL
Memphis Fats Booster Wing	2350-0139	\$119.95	Memphis Hot Wing	2350-0199	\$79.95

KURYAKYN

FAIRING EYEBROWS

FOR VICTORY CROSS COUNTRY, CROSS COUNTRY TOUR, MAGNUM 10-16

- Add an elegant, modern look to the fairing
- Constructed from high-quality, lightweight, chrome-plated ABS
- Simple peel-and-stick installation
- Sold in pairs



SUG. RETAIL \$79.99



PART # 2350-0246

All part numbers in **BOLD MAGENTA** are new this year.

VICTORY

EXHAUST

LUGGAGE

SECURITY

WINDSHIELDS

FAIRINGS & BODY

SEATS & Sissy BARS

HANDLEBARS & HAND CONTROLS

FOOTPEGS & FOOT CONTROLS

LIGHTING

ELECTRICAL

WHEELS & ACCESSORIES

BRAKES & SUSPENSION

ENGINE

FUEL/AIR SYSTEMS

INDIAN

EXHAUST

WINDSHIELDS

FAIRINGS & BODY

SEATS & Sissy BARS

HANDLEBARS & HAND CONTROLS

FOOTPEGS & FOOT CONTROLS

LIGHTING

ELECTRICAL

WHEELS & BRAKES

SUSPENSION

ENGINE

FUEL/AIR SYSTEMS

VICTORY

EXHAUST

LUGGAGE

SECURITY

WINDSHIELDS

FAIRINGS & BODY

SEATS & Sissy BARS

HANDLEBARS & HAND CONTROLS

FOOTPEGS & FOOT CONTROLS

LIGHTING

ELECTRICAL

WHEELS & ACCESSORIES

BRAKES & SUSPENSION

ENGINE

FUEL/AIR SYSTEMS

INDIAN

EXHAUST

WINDSHIELDS

FAIRINGS & BODY

SEATS & Sissy BARS

HANDLEBARS & HAND CONTROLS

FOOTPEGS & FOOT CONTROLS

LIGHTING

ELECTRICAL

WHEELS & BRAKES

SUSPENSION

ENGINE

FUEL/AIR SYSTEMS

Level

Wrapper

Slicer

Tude

TIRE HUGGER SERIES FRONT FENDER FIT KITS FOR VICTORY MODELS



- Steel fenders are thick enough to add rigidity to the front end by acting like a fork brace, but can still be cut or shaped enough for an even more Kustom appearance
- All fenders come predrilled and E-coated and are stamped, not spun, for the ultimate smooth long-lasting fender
- Fenders for 16", 17" and 18" wheels measure 6.25" outside width and will accommodate up to a 140-series tire
- Fenders for 21" wheel with inverted style forks measure 5.875" outside width and will fit the current 120/21 series tires on 3.5" wide rims
- Fenders for 21" wheel with conventional forks measure 4.5" outside width and will fit models listed with the stock narrow rim and a tire up to 100/100-21
- 6061 aluminum mounting blocks included for all applications
- Fenders come with choice of chrome or raw mounting blocks (see chart)
- Made in the U.S.A.

FITS MODEL	DESCRIPTION	PART #	SUG. RETAIL
FOR 16"/17"/18"/19" FRONT WHEEL			
All models with inverted forks 10-14	Level, chrome	1402-0320	\$399.95
	Level, raw	1402-0324	374.95
	Wrapper, chrome	1402-0321	399.95
	Wrapper, raw	1402-0325	374.95
	Slicer, chrome	1402-0322	399.95
	Slicer, raw	1402-0326	374.95
	Tude, chrome	1402-0323	399.95
	Tude, raw	1402-0327	374.95
FOR 21" FRONT WHEEL			
All models with inverted forks 10-14	Level, chrome	1402-0315	399.95
	Level, raw	1402-0319	374.95
	Wrapper, chrome	1402-0312	399.95

FITS MODEL	DESCRIPTION	PART #	SUG. RETAIL
FOR 21" FRONT WHEEL (CONT)			
All models with inverted forks 10-14 (CONT)	Wrapper, raw	1402-0316	\$374.95
	Slicer, chrome	1402-0313	399.95
	Slicer, raw	1402-0317	374.95
	Tude, chrome	1402-0314	399.95
	Tude, raw	1402-0318	374.95
	All models with conventional forks 10-14	Level, chrome	1402-0308
Level, raw		1402-0311	374.95
Wrapper, chrome		1402-0307	399.95
Wrapper, raw		1402-0310	374.95
Slicer, chrome		1402-0306	399.95
Slicer, raw		1402-0309	374.95



FENDER KITS FOR VICTORY CROSS COUNTRY, CROSS ROADS 10-16

- Custom design for a low-profile appearance
- Available for 21" and 23" front wheels
- Stamped 16-gauge steel fenders are ready to prime and paint
- Fenders are pre-drilled for easy installation
- Complete with chrome or black billet fender adapters
- Include fender, brackets and all mounting hardware
- Made in the U.S.A.



DESCRIPTION	PART #	SUG. RETAIL
FOR 21" WHEELS		
Kit w/ chrome brackets	1402-0358	\$399.95
Kit w/ black brackets	1402-0359	399.95

DESCRIPTION	PART #	SUG. RETAIL
FOR 23" WHEELS		
Kit w/ chrome brackets	1402-0360	\$439.95
Kit w/ black brackets	1402-0361	439.95



RADIUS ILLUMINATED VERTICAL SIDE-MOUNT LICENSE PLATE BRACKETS

- Made from 6061-T6 billet aluminum
- Built-in white LEDs illuminate the plate
- Chrome or black anodized finish available
- Work with most 4" x 7" license plates



SUG. RETAIL \$299.95

FITS MODEL	COLOR	PART #
VICTORY		
Vegas 03-16, Vegas 8-Ball 06-16, High Ball 12-16, Gunner 15-16, Jackpot 07-15 (with PAINTED swingarm ONLY), Kingpin 04-15 (all), Boardwalk 13-14, Judge 12-15	Chrome	2030-0994
	Black	2030-0995

FITS MODEL	COLOR	PART #
VICTORY (CONT)		
Hammer 05-06, Jackpot 06 (all), Hammer/Jackpot 07-16 (with CHROME swingarm ONLY), Ness Jackpot 06-16 (see footnote)	Chrome	2030-0996¹

¹ NOTE: to install on 06-16 Ness Jackpot requires the removal of the billet axle cover AND installation of the stock belt tension gauge (OEM PART #5247599).

2-IN-1 SIDE MOUNT LICENSE PLATE MOUNT

- Innovative design lets you mount the plate vertically or horizontally
- Made from 6061 T6 billet aluminum
- Chrome or black anodized finish
- Does not include license plate frame, must be ordered separately
- Accepts most 4" x 7" license plates and license plate frames

SUG. RETAIL \$279.95



FITS MODEL	COLOR	PART #
VICTORY		
Vegas 03-16, Vegas 8-Ball 06-16, High Ball 12-16, Gunner 15-16, Kingpin/Deluxe/Tour/8-Ball 04-15, Boardwalk 13-14, Hammer 07-16 (with PAINTED swingarm ONLY), Jackpot 07-15 (with PAINTED swingarm ONLY), Judge 12-15	Chrome	2030-0997
	Black	2030-0998

FITS MODEL	COLOR	PART #
VICTORY (CONT)		
Hammer 05-06 (all), Jackpot 06 (all), Jackpot 07-15 (with CHROME swingarm ONLY), Hammer 07-15 (with CHROME swingarm ONLY), Ness Jackpot 06-15	Chrome	2030-1001

RADIUS ILLUMINATED LAYDOWN LICENSE PLATE BRACKET FOR KINGPIN/KINGPIN DELUXE/KINGPIN TOUR/KINGPIN 8-BALL 04-15

- Made from 6061-T6 billet aluminum
- Built-in white LEDs illuminate the plate
- Chrome or gloss black finish available
- Fits most 4" x 7" license plates

SUG. RETAIL \$389.95

COLOR	PART #	COLOR	PART #
Chrome	2030-0999	Gloss black	2030-1000



All part numbers in **BOLD MAGENTA** are new this year.

EXHAUST

LUGGAGE

SECURITY

WINDSHIELDS

FAIRINGS & BODY

SEATS & Sissy BARS

HANDLEBARS & HAND CONTROLS

FOOTPEGS & FOOT CONTROLS

LIGHTING

ELECTRICAL

WHEELS & ACCESSORIES

BRAKES & SUSPENSION

ENGINE

FUEL/AIR SYSTEMS

EXHAUST

WINDSHIELDS

FAIRINGS & BODY

SEATS & Sissy BARS

HANDLEBARS & HAND CONTROLS

FOOTPEGS & FOOT CONTROLS

LIGHTING

ELECTRICAL

WHEELS & BRAKES

SUSPENSION

ENGINE

FUEL/AIR SYSTEMS

VICTORY

EXHAUST

LUGGAGE

SECURITY

WINDSHIELDS

FAIRINGS & BODY

SEATS & Sissy BARS

HANDLEBARS & HAND CONTROLS

FOOTPEGS & FOOT CONTROLS

LIGHTING

ELECTRICAL

WHEELS & ACCESSORIES

BRAKES & SUSPENSION

ENGINE

FUEL/AIR SYSTEMS

INDIAN

EXHAUST

WINDSHIELDS

FAIRINGS & BODY

SEATS & Sissy BARS

HANDLEBARS & HAND CONTROLS

FOOTPEGS & FOOT CONTROLS

LIGHTING

ELECTRICAL

WHEELS & BRAKES

SUSPENSION

ENGINE

FUEL/AIR SYSTEMS



precision crafted billet products

SIDE-MOUNT LICENSE PLATES FOR VICTORY CRUISERS

- Billet 6061-T6 construction
- Includes a bright LED license plate light
- Mounts horizontally or vertically
- Mounts on the left side of the swingarm in place of the oval axle adjuster plate
- Window size: 6" x 3 1/4"
- Outside dimensions: 7 1/2" x 4 1/2"
- Mounting holes: 5 3/4" x 2 3/4"
- Available in chrome and black finishes
- Made in the U.S.A.

SUG. RETAIL \$179.95



DESCRIPTION: Black PART #: 2030-0699



DESCRIPTION: Chrome PART #: 2030-0700



2030-0862



2030-0988



LAYDOWN CURVED LICENSE PLATE FRAME WITH LED LICENSE PLATE LIGHT FOR VICTORY CROSS COUNTRY/CROSSROADS 10-16

- Curved plate frame features LED backlighting for full license plate illumination
- 15° mounting angle flows with lines on rear fender
- Simple bolt-on installation
- Fit 4" x 7" license plates

SUG. RETAIL \$119.99

DESCRIPTION	PART #	DESCRIPTION	PART #
Chrome	2030-0862	Satin black	2030-0988



HIDDEN TRAILER HITCH

FOR ALL 10-16 VICTORY CROSS COUNTRY MODELS

- Easy installation requires no welding, cutting or drilling
- 600 lbs. towing capacity
- Mounting hardware and instructions included

SUG. RETAIL \$299.95 PART #: 3902-0189



GAS TANK MINI BRAS

- A great way to help protect a gas tank from buckles, zippers, and knee scratches
- Wraps around the gas tank between rider and the seat, providing a tailored fit design with scratch protection
- Securely attaches with hook-and-loop material to the gas tank, allowing easy access for cleaning
- Made in the U.S.A.

FITS MODEL

VICTORY

Cross Country, Cross Roads and Magnum 10-16 (all)

Gunner 15-16, Highball 12-16, Hammer 05-16, Kingpin 04-12, Judge 13-14, Vegas 03-16



0701-0823



0701-0825



PART # SUG. RETAIL

0701-0823 \$34.95

0701-0825 39.95

CLASSIC BLACK TUXEDO™ TIE WITH POUCH



- Made from marine-grade vinyl
- Features a generous storage pouch with a clear outer pocket
- Includes EZ Lock™ mounting, which allows the pouch to be removed with a twist
- Made in the U.S.A.

SUG. RETAIL \$59.95

FITS MODEL

VICTORY

Cross Country/Cross Roads 10-16

Boardwalk 13-15, Gunner 15-16, Hammer 05-16, Highball 11-16, Jackpot 06-15, Judge 13-15, Kingpin 04-12, Vegas 03-16,



0701-0771



0701-0813

PART #

0701-0771

0701-0813

BAHN

**BAHN™ IGNITION COVERS
FOR ALL VICTORY MODELS 04-16
(EXCEPT JUDGE/BOARDWALK 13-14
AND OCTANE 17)**

- Forged aluminum construction with machined accents
- Covers are bolt-on installation; can be placed vertically or horizontally for personalized customization
- Left- and right-side covers available separately
- Choose from a chrome finish or Tuxedo anodized black and machined finish
- Sold each

SUG. RETAIL\$149.99



DESCRIPTION	PART #	DESCRIPTION	PART #
LEFT SIDE		RIGHT SIDE	
Chrome	2101-0355	Chrome	2101-0354
Tuxedo	2101-0357	Tuxedo	2101-0356

**BAHN™ VALVE COVER ACCENTS
FOR ALL VICTORY 06-16 MODELS
WITH 100" AND 106" MOTORS AND
VICTORY HAMMER 05 WITH 100" MOTOR**

- Accents complement fin design on Victory cylinders
- Install in seconds using high-strength adhesive; no motor disassembly required
- Choose from a chrome finish or Tuxedo anodized black and machined finish
- Sold in pairs

SUG. RETAIL\$149.99

DESCRIPTION	PART #	DESCRIPTION	PART #
Chrome	0940-1399	Tuxedo	0940-1400



**BAHN™ CLUTCH COVER ACCENT
FOR ALL VICTORY
05-16 MODELS
(EXCEPT OCTANE 17)**

- Easy way to dress up the look of your ride
- Forged and machined construction in a non-conventional design
- Choose from a chrome finish or Tuxedo anodized black and machined finish
- Simple bolt-on installation
- Sold each

SUG. RETAIL\$119.99

DESCRIPTION	PART #	DESCRIPTION	PART #
Chrome	1105-0147	Tuxedo	1105-0148



**BAHN™ CRANKCASE COVER ACCENTS
FOR ALL VICTORY
MODELS 05-16
(EXCEPT OCTANE 17)**

- Forged aluminum construction
- Choose from a chrome finish or Tuxedo anodized black and machined finish
- Direct bolt-on installation
- Sold each

SUG. RETAIL\$69.99

DESCRIPTION	PART #	DESCRIPTION	PART #
Chrome	0940-1397	Tuxedo	0940-1398



**BAHN™ LOWER FORK ACCENTS
FOR VICTORY CROSS COUNTRY,
CROSS COUNTRY TOUR, MAGNUM
10-16, CROSSROADS 10-14 AND
HARDBALL MODELS 12-13**

- Forged aluminum construction
- Black anodized finish with re-machined areas for a "Tuxedo" look finish
- Install easily with VHB adhesive
- Sold in pairs

SUG. RETAIL\$79.99



DESCRIPTION	PART #
Tuxedo	0403-0115

All part numbers in **BOLD MAGENTA** are new this year.

EXHAUST

LUGGAGE

SECURITY

WINDSHIELDS

FAIRINGS & BODY

SEATS & Sissy BARS

HANDLEBARS & HAND CONTROLS

FOOTPEGS & FOOT CONTROLS

LIGHTING

ELECTRICAL

WHEELS & ACCESSORIES

BRAKES & SUSPENSION

ENGINE

FUEL/AIR SYSTEMS

INDIAN

EXHAUST

WINDSHIELDS

FAIRINGS & BODY

SEATS & Sissy BARS

HANDLEBARS & HAND CONTROLS

FOOTPEGS & FOOT CONTROLS

LIGHTING

ELECTRICAL

WHEELS & BRAKES

SUSPENSION

ENGINE

FUEL/AIR SYSTEMS

VICTORY

EXHAUST

LUGGAGE

SECURITY

WINDSHIELDS

FAIRINGS & BODY

SEATS & Sissy BARS

HANDLEBARS & HAND CONTROLS

FOOTPEGS & FOOT CONTROLS

LIGHTING

ELECTRICAL

WHEELS & ACCESSORIES

BRAKES & SUSPENSION

ENGINE

FUEL/AIR SYSTEMS

INDIAN

EXHAUST

WINDSHIELDS

FAIRINGS & BODY

SEATS & Sissy BARS

HANDLEBARS & HAND CONTROLS

FOOTPEGS & FOOT CONTROLS

LIGHTING

ELECTRICAL

WHEELS & BRAKES

SUSPENSION

ENGINE

FUEL/AIR SYSTEMS



LED SPEAKER GRILLES FOR VICTORY CROSS COUNTRY/TOUR 10-16

- Speaker housings have integrated blue LED lighted ribs that match the OEM dash lighting
- Polished stainless steel speaker mesh
- Speaker housings are simple bolt-on installation
- Plug-and-play wiring

SUG. RETAIL **\$179.99**

COLOR	PART #	COLOR	PART #
Chrome	2130-0199	Gloss black	2130-0200

TOP DASH ACCENT

FOR CROSS COUNTRY/CROSS COUNTRY TOUR/MAGNUM 10-16

- Injection-molded chrome-plated ABS accent complements OEM gauge bezels
- Also serves as a visor to reduce glare off the gauges
- Simple, peel-and-stick application



SUG. RETAIL **\$54.99** PART # **2202-0223**

CHROME SWITCH PANEL COVER

FOR VICTORY CROSS COUNTRY (EXCEPT 8-BALL), CROSS COUNTRY TOUR, MAGNUM 10-16

- Dress up the inner fairing
- Made of chrome-plated ABS and contoured to fit the OEM dash
- Easy peel-and-stick installation
- Sold each



SUG. RETAIL **\$49.99** PART # **2201-0166**



UPPER AND LOWER FORK LEG COVERS FOR VICTORY CROSS COUNTRY/TOUR/MAGNUM 10-16, CROSS ROADS 10-14, HARDBALL 12-13

- Transform the look of the OEM forks without the need to disassemble them
- Upper fork shrouds are chrome ABS construction
- Simple-peel-and-stick installation
- Lower fork covers are stamped metal construction with a chrome finish, include ABS protective deflector
- Simple bolt-on installation, all necessary hardware included
- Sold in pairs

DESCRIPTION	PART #	SUG. RETAIL	DESCRIPTION	PART #	SUG. RETAIL
UPPER FORK COVERS			LOWER FORK COVERS		
Chrome	0412-0268	\$159.99	Chrome	0412-0269	\$149.99
Gloss black	0450-0283	159.99	Gloss black	0412-0270	149.99

KURYAKYN 

TANK SPEED LINES FOR VICTORY CROSS COUNTRY/ CROSS ROADS/TOUR/MAGNUM 10-16, HARDBALL 12-13

- Durable and lightweight chrome-plated ABS
- Upper and lower accents instantly add dimensional depth to both sides of the tank
- Four-piece kit (two per side)
- Peel-and-stick application

SUG. RETAIL **\$79.99**



PART # **0703-0723**

SPARK PLUG FILLERS FOR VICTORY 06-16 MODELS WITH 100" OR 106" MOTORS AND VICTORY HAMMER 05 WITH 100" MOTOR

- Quality black powder-coated die-cast aluminum with polished outer edges to create the appearance of completely finned jug
- Unique single-screw install fills the void around the spark plugs and coordinates with the outer polished aluminum edge of the motor

SUG. RETAIL **\$89.99**



PART # **0940-1435**

TIE-DOWN BRACKETS FOR VICTORY CROSS COUNTRY (EXCEPT TOUR), CROSSROADS, MAGNUM 10-16, HARDBALL 12-13

- Forged-style brackets provide a secure place to attach tie-downs when transporting the bike
- Install on the upper engine guard mount bracket
- All necessary installation hardware included
- Sold in pairs

SUG. RETAIL **\$59.99**



PART # **3920-0370**

CLUTCH ARM COVER FOR VICTORY 08-16

- Chrome cover with gear-tooth accents
- Bolt-on installation

DESCRIPTION
Chrome



1132-0657

PART #
1132-0657

SUG. RETAIL **\$39.99**

DESCRIPTION
Satin black



1132-0916

PART #
1132-0916

TAILLIGHT TOP TRIM FOR VICTORY CROSS COUNTRY/TOUR, MAGNUM 10-16, CROSSROADS 10-14, HARDBALL 12-13

- Matches the stock chrome around the lower part of taillight
- Peel-and-stick installation

DESCRIPTION
Chrome

PART #
2040-1518

SUG. RETAIL **\$34.99**



2040-1518

DESCRIPTION
Satin black



2010-1274

PART #
2010-1274

VICTORY

EXHAUST

LUGGAGE

SECURITY

WINDSHIELDS

FAIRINGS & BODY

SEATS & Sissy BARS

HANDLEBARS & HAND CONTROLS

FOOTPEGS & FOOT CONTROLS

LIGHTING

ELECTRICAL

WHEELS & ACCESSORIES

BRAKES & SUSPENSION

ENGINE

FUEL/AIR SYSTEMS

INDIAN

EXHAUST

WINDSHIELDS

FAIRINGS & BODY

SEATS & Sissy BARS

HANDLEBARS & HAND CONTROLS

FOOTPEGS & FOOT CONTROLS

LIGHTING

ELECTRICAL

WHEELS & BRAKES

SUSPENSION

ENGINE

FUEL/AIR SYSTEMS

All part numbers in **BOLD MAGENTA** are new this year.

VICTORY

EXHAUST

LUGGAGE

SECURITY

WINDSHIELDS

FAIRINGS & BODY

SEATS & SISSY BARS

HANDLEBARS & HAND CONTROLS

FOOTPEGS & FOOT CONTROLS

LIGHTING

ELECTRICAL

WHEELS & ACCESSORIES

BRAKES & SUSPENSION

ENGINE

FUEL/AIR SYSTEMS

INDIAN

EXHAUST

WINDSHIELDS

FAIRINGS & BODY

SEATS & SISSY BARS

HANDLEBARS & HAND CONTROLS

FOOTPEGS & FOOT CONTROLS

LIGHTING

ELECTRICAL

WHEELS & BRAKES

SUSPENSION

ENGINE

FUEL/AIR SYSTEMS

DRAG
Specialties
SEATS



0810-1544



0822-0135

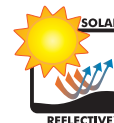

0810-1545



0822-0204



0810-1547



0810-1546

LOW-PROFILE TOURING SEATS WITH BUILT-IN BACKRESTS

- Solar-reflective leather in the seating area and automotive-grade vinyl on the sides; patented process reduces surface temperature by as much as 25°F for a cooler seat, higher durability and longer life over conventional leather or vinyl
- Lower position creates better rider position with improved styling
- Flexible urethane foam for maximum comfort
- Includes backrest pad
- Seats have built-in removable backrest for driver only
- Feature the EZ Glide I system for a smooth and virtually corrosion-free operation
- ³/₁₆" ABS thermoformed seat base with carpeted bottom to protect paint
- Include mounting hardware
- Fit with OEM sissy bar
- Made in the U.S.A.

NOTE: Convertible pad is not compatible with these applications.

FITS MODEL	STYLE	FRONT WIDTH	REAR WIDTH	PART #	SUG. RETAIL
VICTORY					
Cross Country, Crossroads 10-15	Mild stitch	15 ⁵ / ₄ "	15"	0810-1544	\$679.95
	Crusade stitch	15 ⁵ / ₄ "	15"	0810-1545	709.95
	Pillow	15 ⁵ / ₄ "	15"	0810-1546 ¹	599.95
	Flame stitch	15 ⁵ / ₄ "	15"	0810-1547	699.95

¹ No solar leather. Leather-like vinyl in the seating area and automotive grade vinyl on sides. ¹" lighter density foam for added comfort.



0810-1585



0810-1586

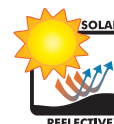

LOW-PROFILE TOURING SEATS WITH PASSENGER BACKREST

- Solar-reflective leather in the seating area and automotive-grade vinyl on the sides; patented process reduces surface temperature by as much as 25°F for a cooler seat, higher durability and longer life over conventional leather or vinyl
- Lower position creates better rider position with improved styling
- Flexible urethane foam for maximum comfort
- Includes passenger backrest mounted to seat
- ³/₁₆" ABS thermoformed seat base with carpeted bottom to protect paint
- Include mounting hardware
- Made in the U.S.A.

NOTE: "The Convertible" backrest is not compatible with Victory applications.

FITS MODEL	STYLE	FRONT WIDTH	REAR WIDTH	PART #	SUG. RETAIL
VICTORY					
Hammer 05-15	Mild stitch	14 ¹ / ₂ "	13"	0810-1585	\$469.95
	Flame stitch	14 ¹ / ₂ "	13"	0810-1586	479.95



0810-1540



0822-0135



0822-0204



0810-1543

0810-1542

LOW-PROFILE TOURING SEATS FOR VICTORY OEM BACKREST

- Solar-reflective leather in the seating area and automotive-grade vinyl on the sides; patented process reduces surface temperature by as much as 25°F for a cooler seat, higher durability and longer life over conventional leather or vinyl
- Lower position creates better rider position with improved styling
- Flexible urethane foam for maximum comfort
- Seats can be used with or without driver backrest
- Will fit with OEM sissy bar
- Seats do not include mechanism or pad
- Seats are designed to be used with Victory's driver backrest frame mount and pad
- PART #0822-0135 and PART #0822-0204 (pillow) will position the pad 1" further back; pads are compatible with Victory's frame mount
- ³/₁₆" ABS thermoformed seat base with carpeted bottom to protect paint
- Include mounting hardware
- Made in the U.S.A.

NOTE: "The Convertible" backrest is not compatible with Victory applications.

FITS MODEL	STYLE	FRONT WIDTH	REAR WIDTH	PART #	SUG. RETAIL
VICTORY					
Cross Country, Crossroads 10-15	Mild stitch	15 ³ / ₄ "	15"	0810-1540	\$489.95
	Crusade stitch	15 ³ / ₄ "	15"	0810-1541	489.95
	Pillow	15 ³ / ₄ "	15"	0810-1542¹	399.95
	Flame stitch	15 ³ / ₄ "	15"	0810-1543	489.95

¹ No solar leather. Leather-like vinyl in the seating area and automotive-grade vinyl on sides. 1" lighter density foam for added comfort.

OPTIONAL DRIVER BACKRESTS

DESCRIPTION	STYLE	PART #	SUG. RETAIL
EZ Glide I™ backrest (w/ pouch) (10" W x 7 ¹ / ₂ " H)	Smooth	0822-0135	\$184.95
EZ Glide I™ backrest (w/ pouch on back) (10" W x 7 ¹ / ₂ " H)	Pillow-style	0822-0204	179.95

All part numbers in **BOLD MAGENTA** are new this year.



VICTORY

EXHAUST

LUGGAGE

SECURITY

WINDSHIELDS

FAIRINGS & BODY

SEATS & SISSY BARS

HANDLEBARS & HAND CONTROLS

FOOTPEGS & FOOT CONTROLS

LIGHTING

ELECTRICAL

WHEELS & ACCESSORIES

BRAKES & SUSPENSION

ENGINE

FUEL/AIR SYSTEMS

INDIAN

EXHAUST

WINDSHIELDS

FAIRINGS & BODY

SEATS & SISSY BARS

HANDLEBARS & HAND CONTROLS

FOOTPEGS & FOOT CONTROLS

LIGHTING

ELECTRICAL

WHEELS & BRAKES

SUSPENSION

ENGINE

FUEL/AIR SYSTEMS



0810-1575



0810-1576



0810-1577



0810-1578



0810-1605

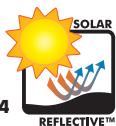

0810-1606



0810-1607



0810-1608



0822-0133



0822-0154



0822-0189

LOW-PROFILE TOURING SEATS WITH BACKREST OPTION

- Solar-reflective leather in the seating area and automotive-grade vinyl on the sides; patented process reduces surface temperature by as much as 25°F for a cooler seat, higher durability and longer life over conventional leather or vinyl
- Flexible urethane foam interior for maximum comfort
- ³/₁₆" ABS thermoformed seat base with carpeted bottom and rubber bumpers to protect paint
- Lower position creates better rider position with improved styling
- Seats can be used with or without driver backrest
- Seats accept optional EZ Glide II™ backrests PART #s 0822-0133, 0822-0154 or 0822-0189, sold separately
- Include mounting hardware
- Made in the U.S.A.

FITS MODEL

VICTORY

Jackpot, Vegas Jackpot 06-14 (includes Ness models)

King Pin 04-12, Gunner 14-16, Vegas 03-16, 8-Ball 05-16, High Ball 12-16 (includes Ness models)

STYLE	FRONT WIDTH	REAR WIDTH	PART #	SUG. RETAIL
Smooth	14"	11"	0810-1575 ^{2, 3}	\$419.95
Crusade stitch	14"	11"	0810-1576 ^{2, 3}	439.95
Pillow	14"	11"	0810-1577 ^{1, 2, 3}	379.95
Flame	14"	11"	0810-1578 ^{2, 3}	439.95
Smooth	15"	12"	0810-1605 ²	419.95
Crusade	15"	12"	0810-1606 ²	449.95
Pillow-style	15"	12"	0810-1607 ^{1, 2}	369.95
Flame stitch	15"	12"	0810-1608 ²	439.95

¹ No solar leather. Leather-like vinyl in the seating area and automotive grade vinyl on sides. 1" lighter density foam for added comfort.

² No backrest included.

³ Will not work with OEM backrests.

OPTIONAL BACKRESTS

DESCRIPTION	STYLE	PART #	SUG. RETAIL
EZ Glide II™ backrest (9" W x 5 1/4" H)	Smooth	0822-0133	\$184.95
EZ Glide III™ backrest (10" W x 7 1/2" H)	Smooth	0822-0154	179.95
EZ Glide II™ backrest (w/ pouch on back) (10" W x 7 1/2" H)	Pillow	0822-0189	179.95



0810-1581



0822-0133

0810-1581



0810-1582



0822-0154

0810-1582



0810-1583



0810-1584

PREDATOR SEATS WITH DRIVER BACKREST OPTION

- Solar-reflective leather in the seating area and automotive-grade vinyl on the sides; patented process reduces surface temperature by as much as 25°F for a cooler seat, higher durability and longer life over conventional leather or vinyl
- Flexible urethane foam for maximum comfort
- ³/₁₆" ABS thermoformed seat base with carpeted bottom to protect paint
- Seats feature an EZ Glide II™ driver backrest mechanism and accept optional backrests: PART #s 0822-0133 or 0822-0154, sold separately
- Includes mounting hardware
- Made in the U.S.A.

FITS MODEL	STYLE	FRONT WIDTH	PART #	SUG. RETAIL
VICTORY				
Hammer 05-16	Smooth	13"	0810-1581	\$349.95
(includes Ness models)	Tribal flame stitch	13"	0810-1582	369.95
	Carbon fiber stitch	13"	0810-1583	319.95
	Caballero stitch	13"	0810-1584	349.95



OPTIONAL DRIVER BACKRESTS

DESCRIPTION	PART #	SUG. RETAIL
EZ GLIDE II™ backrest (9" W x 5 ¹ / ₄ " H), smooth	0822-0133	\$184.95
EZ GLIDE III™ backrest (10" W x 7 ¹ / ₂ " H), smooth	0822-0154	179.95

VICTORY

EXHAUST

LUGGAGE

SECURITY

WINDSHIELDS

FAIRINGS & BODY

SEATS & SISSY BARS

HANDLEBARS & HAND CONTROLS

FOOTPEGS & FOOT CONTROLS

LIGHTING

ELECTRICAL

WHEELS & ACCESSORIES

BRAKES & SUSPENSION

ENGINE

FUEL/AIR SYSTEMS

INDIAN

EXHAUST

WINDSHIELDS

FAIRINGS & BODY

SEATS & SISSY BARS

HANDLEBARS & HAND CONTROLS

FOOTPEGS & FOOT CONTROLS

LIGHTING

ELECTRICAL

WHEELS & BRAKES

SUSPENSION

ENGINE

FUEL/AIR SYSTEMS

All part numbers in **BOLD MAGENTA** are new this year.



VICTORY

EXHAUST

LUGGAGE

SECURITY

WINDSHIELDS

FAIRINGS & BODY

SEATS & SISSY BARS

HANDLEBARS & HAND CONTROLS

FOOTPEGS & FOOT CONTROLS

LIGHTING

ELECTRICAL

WHEELS & ACCESSORIES

BRAKES & SUSPENSION

ENGINE

FUEL/AIR SYSTEMS

INDIAN

EXHAUST

WINDSHIELDS

FAIRINGS & BODY

SEATS & SISSY BARS

HANDLEBARS & HAND CONTROLS

FOOTPEGS & FOOT CONTROLS

LIGHTING

ELECTRICAL

WHEELS & BRAKES

SUSPENSION

ENGINE

FUEL/AIR SYSTEMS



0810-1537



0810-1538



0810-1539

2-UP PREDATOR SEAT

- Solar-reflective leather in the seating area and automotive-grade vinyl on the sides; patented process reduces surface temperature by as much as 25°F for a cooler seat, higher durability and longer life over conventional leather or vinyl
- Flexible urethane foam for maximum comfort
- ³/₁₆" ABS thermoformed seat base with carpeted bottom to protect paint
- Will fit with OEM sissy bars
- Lowers rider 1" and improves seating position
- Includes mounting hardware
- Made in the U.S.A.

FITS MODEL	STYLE	FRONT WIDTH	PART #	SUC. RETAIL
VICTORY				
Cross Country/Tour, Cross Roads, HardBall 10-16	Mild stitch	11"	0810-1537	\$419.95
	Crusade stitch	11"	0810-1538	439.95
	Flame stitch	11"	0810-1539	439.95



0810-1572



0810-1573



0810-1574



0810-1596



0810-1597



0810-1598

PREDATOR SEATS

- Solar-reflective leather in the seating area and automotive-grade vinyl on the sides; patented process reduces surface temperature by as much as 25°F for a cooler seat, higher durability and longer life over conventional leather or vinyl
- Flexible urethane foam for maximum comfort
- ³/₁₆" ABS thermoformed seat base with carpeted bottom to protect paint
- Include mounting hardware
- Made in the U.S.A.

FITS MODEL

VICTORY

Jackpot, Vegas Jackpot 06-14 (includes Ness models)

King Pin 04-12, Gunner 14-16, Vegas 03-16, 8-Ball 05-16, High Ball 12-16 (includes Ness models)

STYLE	FRONT WIDTH	PART #	SUG. RETAIL
Smooth	12 ¹ / ₂ "	0810-1572	\$304.95
Flame stitch	12 ¹ / ₂ "	0810-1573	\$39.95
Crusade stitch	12 ¹ / ₂ "	0810-1574	\$39.95
Smooth	12"	0810-1596	299.95
Flame stitch	12"	0810-1597	319.95
Crusade stitch	12"	0810-1598	339.95

All part numbers in **BOLD MAGENTA** are new this year.

partsnetweb.com / dragnetweb.com

VICTORY

EXHAUST

LUGGAGE

SECURITY

WINDSHIELDS

FAIRINGS & BODY

SEATS & SISSY BARS

HANDLEBARS & HAND CONTROLS

FOOTPEGS & FOOT CONTROLS

LIGHTING

ELECTRICAL

WHEELS & ACCESSORIES

BRAKES & SUSPENSION

ENGINE

FUEL/AIR SYSTEMS

INDIAN

EXHAUST

WINDSHIELDS

FAIRINGS & BODY

SEATS & SISSY BARS

HANDLEBARS & HAND CONTROLS

FOOTPEGS & FOOT CONTROLS

LIGHTING

ELECTRICAL

WHEELS & BRAKES

SUSPENSION

ENGINE

FUEL/AIR SYSTEMS



VICTORY

EXHAUST

LUGGAGE

SECURITY

WINDSHIELDS

FAIRINGS & BODY

SEATS & SISSY BARS

HANDLEBARS & HAND CONTROLS

FOOTPEGS & FOOT CONTROLS

LIGHTING

ELECTRICAL

WHEELS & ACCESSORIES

BRAKES & SUSPENSION

ENGINE

FUEL/AIR SYSTEMS

INDIAN

EXHAUST

WINDSHIELDS

FAIRINGS & BODY

SEATS & SISSY BARS

HANDLEBARS & HAND CONTROLS

FOOTPEGS & FOOT CONTROLS

LIGHTING

ELECTRICAL

WHEELS & BRAKES

SUSPENSION

ENGINE

FUEL/AIR SYSTEMS



0810-1603



0822-0133

0810-1604

SOLO SEATS WITH BACKREST OPTION

- Solar-reflective leather in the seating area and automotive-grade vinyl on the sides; patented process reduces surface temperature by as much as 25°F for a cooler seat, higher durability and longer life over conventional leather or vinyl
- Low-profile design with molded flexible urethane foam interior for maximum comfort and styling
- ³/₁₆" ABS thermoformed seat base for a perfect fit, and fully carpeted bottom with rubber bumpers to protect paint
- Lower and improve seating position
- Seats accept optional EZ Glide II™ backrests PART #s 0822-0133 or 0822-0154, sold separately
- Include mounting hardware
- Made in the U.S.A.

FITS MODEL	STYLE	FRONT WIDTH	PART #	SUG. RETAIL
VICTORY				
King Pin 04-12, Gunner 14-16, Vegas 03-16, 8-Ball 05-16, High Ball 12-16 (includes Ness models)	Smooth	14 1/2"	0810-1603	\$284.95
	Flame	14 1/2"	0810-1604	294.95



0822-0133



0822-0154

Back view

OPTIONAL BACKRESTS

DESCRIPTION	PART #	SUG. RETAIL	DESCRIPTION	PART #	SUG. RETAIL
EZ GLIDE II™ backrest (9" W x 5 1/4" H), smooth	0822-0133	\$184.95	EZ GLIDE III™ backrest (10" W x 7 1/2" H), smooth	0822-0154	\$179.95



0810-1599



0810-1600



0810-1601



0810-1885



0810-1602

LOW-PROFILE SOLO SEATS

- Solar-reflective leather in the seating area and automotive-grade vinyl on the sides; patented process reduces surface temperature by as much as 25°F for a cooler seat, higher durability and longer life over conventional leather or vinyl
- Flexible urethane foam for maximum comfort
- ³/₁₆" ABS thermoformed seat base with carpeted bottom to protect paint
- Lower position creates better rider position with improved styling
- Include mounting hardware
- Made in the U.S.A.

FITS MODELS	STYLE	FRONT WIDTH	PART #	SUG. RETAIL
VICTORY				
King Pin 04-12, Gunner 14-16, Vegas 03-16, 8-Ball 05-16, High Ball 12-16 (includes Ness models)	Smooth	13 1/2"	0810-1599	\$229.95
	Flame stitch	13 1/2"	0810-1600	239.95
	Diamond stitch	13 1/2"	0810-1601	249.95
	Diamond stitch w/ red top	13 1/2"	0810-1885	239.95
	Classic stitch	13 1/2"	0810-1602	239.95



WIDE VINTAGE TOURING SEAT WITH DRIVER BACKREST

- Deeply contoured front bucket; passenger seat angles forward to support the rider's back
- Premium-quality expanded vinyl cover
- Built-in steel support wings in the passenger seat
- Features a clean look with no studs or conchos
- Removable contoured driver backrest pad measures 7" H x 12" W x 1.5" D
- Backrest folds completely forward for ease of getting on motorcycle
- Backrest pivots to match your back angle
- Rounded thumb screw adjusts backrest forward and back up to 2" while you are seated
- Backrest easily snaps into four height positions
- Made in the U.S.A.

SUG. RETAIL\$846.00

FITS MODEL	FRONT WIDTH	REAR WIDTH	PART #
VICTORY			
8-Ball 03-15	15.5"	12"	0810-0499
High-Ball 12-15	15.5"	12"	0810-0499



FITS MODEL	FRONT WIDTH	REAR WIDTH	PART #
VICTORY (CONT)			
Kingpin 03-13	15.5"	12"	0810-0499
Vegas 03-16	15.5"	12"	0810-0499

WIDE VINTAGE TOURING TWO-PIECE SEAT

- Deeply contoured front bucket; passenger seat angles forward to support the rider's back
- Premium-quality, expanded vinyl cover
- Built-in steel support wings in the passenger seat
- No studs or conchos for a clean, smooth look
- Made in the U.S.A.

SUG. RETAIL\$652.00

FITS MODEL	FRONT WIDTH	REAR WIDTH	PART #
VICTORY			
8-Ball 03-14	15.5"	12"	0810-0492
High-Ball 12-15	15.5"	12"	0810-0492

FITS MODEL	FRONT WIDTH	REAR WIDTH	PART #
VICTORY (CONT)			
Kingpin 03-12	15.5"	12"	0810-0492
Vegas 03-16	15.5"	12"	0810-0492



WIDE VINTAGE TOURING SEATS FOR VICTORY CROSS COUNTRY 10-16/CORY NESS CROSS COUNTRY 11-15/CROSS COUNTRY TOUR 12-16/CROSS ROADS 10, 12-15/CROSS ROADS CUSTOM 11/HARD BALL 12-13/MAGNUM 15-16

- Durable synthetic glove leather
- Sits rider 1/4" lower than stock
- Backrest model features a driver backrest and receiver for an optional passenger backrest
- Backrest is fully adjustable and easily interchanged from rider to passenger
- Seat dimensions: 15.5" front width, 12" back width
- Made in the U.S.A.

NOTE: This seat is designed to fit with stock saddlebags and crash bars. If the seat makes contact with either of these, the saddlebag position can be adjusted on the mounts or by adding a washer to the front mount.

DESCRIPTION	PART #	SUG. RETAIL
Wide touring w/o backrest receivers	0810-1419	\$499.00
Wide touring w/ driver backrest/passenger receiver	0810-1421	754.00



DESCRIPTION	PART #	SUG. RETAIL
Interchangeable backrest	0822-0198	\$214.00

All part numbers in **BOLD MAGENTA** are new this year.

VICTORY

EXHAUST

LUGGAGE

SECURITY

WINDSHIELDS

FAIRINGS & BODY

SEATS & SISSY BARS

HANDLEBARS & HAND CONTROLS

FOOTPEGS & FOOT CONTROLS

LIGHTING

ELECTRICAL

WHEELS & ACCESSORIES

BRAKES & SUSPENSION

ENGINE

FUEL/AIR SYSTEMS

INDIAN

EXHAUST

WINDSHIELDS

FAIRINGS & BODY

SEATS & SISSY BARS

HANDLEBARS & HAND CONTROLS

FOOTPEGS & FOOT CONTROLS

LIGHTING

ELECTRICAL

WHEELS & BRAKES

SUSPENSION

ENGINE

FUEL/AIR SYSTEMS



HEATED ONE-PIECE TOURING SEAT WITH DRIVER BACKREST

FOR VICTORY VISION 08-16

- Seat driver and passenger areas have a widened bucket radius
- Slightly lower seat height ensures the rider can easily put a foot down at stop
- Seat has driver and passenger heating components with dual high/low control
- Premium-quality expanded vinyl cover
- Built-in steel support wings in the passenger seat
- Detailed stitching accents
- Will work with stock passenger trunk backrest
- Removable driver's backrest included
- Seat dimensions: 17.5" front width, 15.5" back width
- Made in the U.S.A.

SUG. RETAIL \$889.00

PART #

0810-1919



KURYAKYN

PLUG-N-GO DRIVER BACKREST FOR CROSS COUNTRY/TOUR, CROSSROADS AND HARD BALL MODELS 10-16 W/ STOCK SEAT

- Add comfort and convenience
- Included quick-detach installation hardware makes this backrest easy to take on/off
- Full range of forward, rear and vertical adjustment points for perfect comfort
- Backrest has a removable pouch for convenient storage
- Extra-wide mounting base
- Measures 13" W x 10" H x 4 1/4" D

SUG. RETAIL \$229.99

PART #

0822-0226



KURYAKYN

BACKREST MOUNT KIT

FOR VICTORY CROSS COUNTRY 10-16 (EXCEPT CROSS COUNTRY TOUR 12-16 AND CORY NESS CROSS COUNTRY TOUR 13), MAGNUM 15-16, HARDBALL 12-13, CROSS ROADS 10-14 (WITH HARD SADDLEBAGS)

- Mount kit for Kuryakyn multipurpose backrests

SUG. RETAIL \$149.99

PART #

0822-0227



CHROME ARMRESTS

FOR VICTORY CROSS TOUR MODELS 10-16

- Swinging arms with magnetic retention for easy access and storage
- 2" thick arm pad
- Chrome plated aluminum
- Bolt-on installation

SUG. RETAIL \$349.95

PART #

0822-0293

VICTORY

EXHAUST

LUGGAGE

SECURITY

WINDSHIELDS

FAIRINGS & BODY

SEATS & Sissy BARS

HANDLEBARS & HAND CONTROLS

FOOTPEGS & FOOT CONTROLS

LIGHTING

ELECTRICAL

WHEELS & ACCESSORIES

BRAKES & SUSPENSION

ENGINE

FUEL/AIR SYSTEMS

INDIAN

EXHAUST

WINDSHIELDS

FAIRINGS & BODY

SEATS & Sissy BARS

HANDLEBARS & HAND CONTROLS

FOOTPEGS & FOOT CONTROLS

LIGHTING

ELECTRICAL

WHEELS & BRAKES

SUSPENSION

ENGINE

FUEL/AIR SYSTEMS



0601-0871



0601-0872



1 1/2" T-BARS

FOR VICTORY (ALL MODELS EXCEPT TOURING)

- The ultimate handlebar, designed for maximum comfort
- Brilliantly show-chromed
- Accept standard 1" controls
- Thread pitch: M12 x 1.25
- Mounting bolts sold separately
- Made in the U.S.A.

SUG. RETAIL **\$219.95**

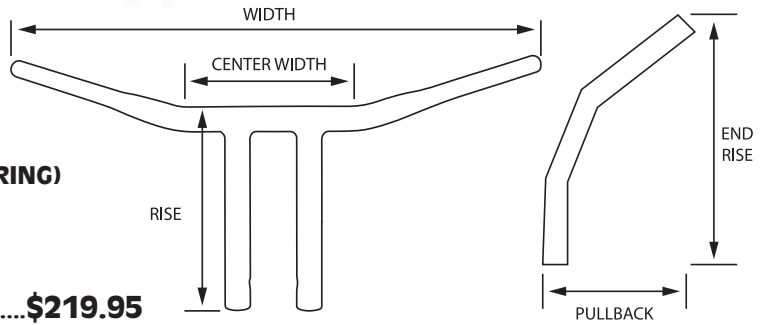

DESCRIPTION	HEIGHT	PULLBACK	RISER CENTER WIDTH	WIDTH	PART #
Radius	7"	15"	5 1/8"	33 1/2"	0601-0871
Super Radius	8"	15"	5 1/8"	33 1/2"	0601-0872



0601-2432



0601-2434

1" DIAMETER KLIP HANGER HANDLEBARS FOR VICTORY CROSS COUNTRY/ CROSS COUNTRY TOUR/ NESS CROSS COUNTRY (ALL)



- Handlebars are manufactured from DOM tubing
- Clamps are machined from 6061 billet aluminum and use stainless steel mounting hardware
- Handlebar clamps allow the handlebar to be adjusted in several directions to allow the rider to find that perfect fit
- Drilled and slotted for internal wiring
- Center section (riser clamp area) is fully knurled for use with standard risers
- Include chrome billet aluminum handlebar end plugs for a finished look
- Made in the U.S.A.

SUG. RETAIL **\$459.95**

DESCRIPTION	END RISE	WIDTH	CENTER WIDTH	PULLBACK	PART #
Black/chrome	15"	35"	11"	15"	0601-2432
Black/black	15"	35"	11"	15"	0601-2433
Chrome/chrome	15"	35"	11"	15"	0601-2434

All part numbers in **BOLD MAGENTA** are new this year.

HANDLEBARS & HAND CONTROLS

VICTORY

EXHAUST

LUGGAGE

SECURITY

WINDSHIELDS

FAIRINGS & BODY

SEATS & Sissy BARS

HANDLEBARS & HAND CONTROLS

FOOTPEGS & FOOT CONTROLS

LIGHTING

ELECTRICAL

WHEELS & ACCESSORIES

BRAKES & SUSPENSION

ENGINE

FUEL/AIR SYSTEMS

INDIAN

EXHAUST

WINDSHIELDS

FAIRINGS & BODY

SEATS & Sissy BARS

HANDLEBARS & HAND CONTROLS

FOOTPEGS & FOOT CONTROLS

LIGHTING

ELECTRICAL

WHEELS & BRAKES

SUSPENSION

ENGINE

FUEL/AIR SYSTEMS

0612-0327

0610-0236

0610-0239

0612-0323



CONTOUR BILLET HANDLEBAR CONTROLS FOR VICTORY CROSS COUNTRY/CROSS COUNTRY TOUR 10-16

- CNC-machined in billet aluminum and available in chrome or Contrast Cut™ finishes
- Contrast Cut™ starts with a polished hand control that has been black anodized, then recut to open up the design
- Hydraulic brake master cylinder comes in 9/16" or 11/16" bore size
- Hydraulic clutch cylinder is available in 11/16" bore size
- Cable-actuated clutch control works with stock cable
- Handlebar switch housings and brake light switches are not included and must be purchased separately
- Made in the U.S.A.

NOTE: Controls will NOT work with OEM cables. Installation requires NAMZ custom cable conversion kit PART #0650-1512 or 0650-1510; sold separately, see below.

DESCRIPTION	PART #	SUG. RETAIL	DESCRIPTION	PART #	SUG. RETAIL
11/16" BORE HYDRAULIC CLUTCH CONTROL			11/16" BORE HYDRAULIC BRAKE CONTROL DUAL CALIPER		
Contrast Cut	0612-0326	\$369.95	Chrome	0610-0239	\$369.95
Chrome	0612-0327	369.95	Contrast Cut	0610-0240	369.95
9/16" BORE HYDRAULIC BRAKE CONTROL SINGLE CALIPER			CABLE ACTUATED CLUTCH LEVER ASSEMBLIES		
Chrome	0610-0235	369.95	Contrast Cut w/ starter interrupter switch	0612-0323	269.95
Contrast Cut	0610-0236	369.95	Chrome w/ starter interrupter switch	0612-0324	269.95



2106-0383



2106-0384



0650-1612



0650-1613

HANDLEBAR CONTROL CONVERSION KITS FOR VICTORY CROSS COUNTRY MODELS 12-16

- Exclusive kit to Drag Specialties/Part Unlimited U.S.A.
- Allows Performance Machine handlebar 3-button housing/switches and Contour Billet handlebar controls to be used on Victory Cross Country models 12-16
- Includes wiring, heat shrink, Hazard and Mode rocker switches
- Available with black or chrome mounting brackets
- Please see page ??? for 3-button handlebar housings/switches
- For Contour Billet dual-disc brake controls and cable-actuated clutch lever assemblies; see below

NOTE: 3-button handlebar housings/switches and handlebar controls must be used together
NOTE: Kits listed must be used with NAMZ cable kits PART #s 0650-1612 and 0650-1613. See chart.



DESCRIPTION	PART #	SUG. RETAIL
Black	2106-0383	\$179.95
Chrome	2106-0384	179.95

CABLE KITS

DESCRIPTION	PART #	SUG. RETAIL
Black	0650-1612	\$239.95
Stainless	0650-1613	294.95

CONTOUR HANDLEBAR CONTROL SPACERS FOR VICTORY CROSS COUNTRY/CROSS COUNTRY TOUR 10-16

- Fill unsightly gaps between switch housings and grips
- Performance Machine adapters allow the use of PM hand controls on most 1" OD diameter handlebars
- For both left and right applications
- Made in the U.S.A.

NOTE: Some handlebars may require slight filing for proper fit.



0616-0103

0616-0104

DESCRIPTION	PART #	SUG. RETAIL	DESCRIPTION	PART #	SUG. RETAIL
For cable-actuated clutch control, chrome	0616-0102	\$21.95	For hydraulic clutch control, chrome	0616-0104	\$21.95
For cable-actuated clutch control, black anodized	0616-0103	21.95	For hydraulic clutch control, black anodized	0616-0105	21.95

CONTOUR BILLET HANDLEBAR SWITCHES FOR VICTORY CROSS COUNTRY/CROSS COUNTRY TOUR 10-16

- 3-button housing includes high-quality switches with 36" leads
- Work exclusively with Performance Machine Contour hand controls
- Sold each
- Made in the U.S.A.

0616-0099



0616-0096



0632-0423



0632-0424

THROTTLE HOUSINGS

- Dual cable, snap-in style throttle housings
- Your choice of chrome or black anodized finishes
- For 1" OD diameter handlebars
- Made in the U.S.A.

SUG. RETAIL\$89.95

DESCRIPTION	PART #	SUG. RETAIL	DESCRIPTION	PART #	SUG. RETAIL
RIGHT SIDE HOUSING					
Chrome	0616-0096	\$229.95	LEFT SIDE HOUSING (FOR CABLE CLUTCH)		
Black anodized	0616-0097	229.95	Chrome	0616-0098	\$229.95
			Black anodized	0616-0099	229.95
			Chrome	0632-0423	
			Black anodized	0632-0424	

KURYAKYN 



SPEAR GRIPS FOR VICTORY OCTANE 17

- Grip housings are cast aluminum with a chrome-plated finish
- Embedded soft EPDM rubber inserts provide sure grip in all conditions, reduce vibration and allow airflow
- Sold in pairs

SUG. RETAIL **\$89.99** PART # **0630-1840**



0630-0186



0630-0212



0630-0636

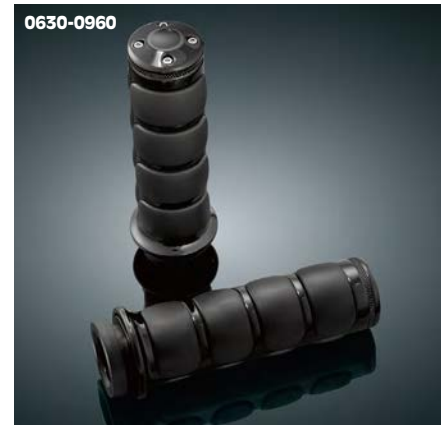

0630-0960

ISO®, ISO®-FLAME AND TRANSFORMER GRIPS FOR ALL VICTORY MODELS (EXCEPT VISION)

- Combine style and comfort in a soft, nonslip surface that dampens handlebar vibrations
- Recessed area between ISO™-Pads allows cooling airflow in warm weather
- Knurled accent ring adds a touch of class
- Flame grips feature a unique flamed pattern and Maltese Cross end caps
- Transformer grips feature interchangeable Widow, Zombie and Maltese cross medallions to mix/match with other Kuryakyn accessories; one pair of each style of emblem included
- All styles are sold in pairs

NOTE: Not compatible with bar-end weights.

DESCRIPTION	PART #	SUG. RETAIL
CHROME		
ISO®-grips	0630-0186	\$79.99
Flame ISO®-grips	0630-0212	79.99
Transformer grips	0630-0636	89.99

DESCRIPTION	PART #	SUG. RETAIL
GLOSS BLACK		
ISO®-grips	0630-0960	\$79.99



0630-1661



0630-1662

KINETIC GRIPS

- Designed to keep you moving forward with the latest in styling and vibration-isolating technology
- Featuring an aluminum body and EPDM rubber to help you ride with less fatigue and more control in a modern design
- Designed to coordinate with the entire Kinetic™ line of accessories
- Available in chrome or gloss black finishes
- Sold in pairs

SUG. RETAIL ... \$89.99

DESCRIPTION	PART #
FOR ALL MODELS 99-16 (EXCEPT VISION, CROSS COUNTRY TOUR WITH HEATED GRIPS, OCTANE)	
Chrome	0630-1661
Gloss black	0630-1662
FOR OCTANE 17	
Gloss black	0630-1823



0634-0197

MECHANICAL CRUISE ASSIST

- Looks like a bar-end weight
- Spring-loaded tensioner inside holds the throttle in position once you set it with your little finger
- Easy throttle shut-down – just roll the throttle forward to disengage
- Optional matching clutch bar end weight available separately
- For use with OEM or Kuryakyn ISO®, Flame or Transformer grips

CRUISE ASSIST SUG. RETAIL \$89.99 **OPTIONAL BAR-END WEIGHT SUG. RETAIL \$34.99**

FITS MODEL	CRUISE ASSIST PART #	CLUTCH BAR END WEIGHT PART #
VICTORY		
Kingpin, Vegas 04-14 (w/ Kuryakyn grips)	0634-0197	0634-0198
Hammer 06-14 (w/ Kuryakyn grips)	0634-0197	0634-0198

All part numbers in **BOLD MAGENTA** are new this year.

VICTORY

EXHAUST

LUGGAGE

SECURITY

WINDSHIELDS

FAIRINGS & BODY

SEATS & Sissy BARS

HANDLEBARS & HAND CONTROLS

FOOTPEGS & FOOT CONTROLS

LIGHTING

ELECTRICAL

WHEELS & ACCESSORIES

BRAKES & SUSPENSION

ENGINE

FUEL/AIR SYSTEMS

INDIAN

EXHAUST

WINDSHIELDS

FAIRINGS & BODY

SEATS & Sissy BARS

HANDLEBARS & HAND CONTROLS

FOOTPEGS & FOOT CONTROLS

LIGHTING

ELECTRICAL

WHEELS & BRAKES

SUSPENSION

ENGINE

FUEL/AIR SYSTEMS

VICTORY

EXHAUST

LUGGAGE

SECURITY

WINDSHIELDS

FAIRINGS & BODY

SEATS & Sissy BARS

HANDLEBARS & HAND CONTROLS

FOOTPEGS & FOOT CONTROLS

LIGHTING

ELECTRICAL

WHEELS & ACCESSORIES

BRAKES & SUSPENSION

ENGINE

FUEL/AIR SYSTEMS

INDIAN

EXHAUST

WINDSHIELDS

FAIRINGS & BODY

SEATS & Sissy BARS

HANDLEBARS & HAND CONTROLS

FOOTPEGS & FOOT CONTROLS

LIGHTING

ELECTRICAL

WHEELS & BRAKES

SUSPENSION

ENGINE

FUEL/AIR SYSTEMS

0640-0912



0640-0913



BAHN™ MIRRORS

BAHN

- Mirrors are high-quality forged aluminum construction
- Improved rear-view vision due to beveled glass and large, stylish mirror heads that meet DOT size standards
- Mirror heads measure 5" W x 3 1/8" H
- Choose from a chrome finish or Tuxedo anodized black and machined finish
- Sold in pairs

NOTE: Not recommended for Buckhorn handlebars.

NOTE: Require Metric Mirror Adapter PART #s 0641-0118 or 0641-0120 for installation; sold separately.

SUG. RETAIL \$209.99

DESCRIPTION	PART #	DESCRIPTION	PART #
Tuxedo	0640-0912	Chrome	0640-0913

KURYAKYN

TRIDENT BAR-END MIRROR FOR VICTORY CROSS COUNTRY/CROSS ROADS/MAGNUM 10-16, HAMMER 10-16, HARD BALL 10-16, KINGPIN 04-16 AND VEGAS 04-16



- Transform the look of your handlebars and move the mirrors to a wider, more useful position
- For use with 7/8" or 1" diameter hollow handlebars
- Wedge-in style
- Handlebar must have at least 2 3/4" depth of open bar end
- Sold each

NOTE: Proper installation requires cutting or drilling a 5/8" hole in the end of the OEM grips. Proper installation requires 7/8" or 1" diameter handlebars with open ends. Not compatible with Kuryakyn chrome-style Throttle Bosses that screw to the end of the Kuryakyn grips or other grip end accessories or bar end weights. Not suggested for Buckhorn-style handlebars.

NOTE: Suggested installation of mirror is on the left grip clutch side only.

NOTE: Must have Kuryakyn grips installed.

SUG. RETAIL \$79.99

PART # 0640-0663

KURYAKYN

RAISED MIRROR ADAPTERS FOR ALL VICTORY MODELS 08-16 (EXCEPT VISION)



- Provide a raised mirror mount location essential for mounting Kuryakyn mirrors
- Raise mirror mounting position approximately 1 1/2"
- Allow clearance from brake master cylinder and greatly improve visibility
- Quality stainless steel with a polished finish for a stunning appearance
- Sold in pairs

SUG. RETAIL \$17.99

PART # 0641-0178



STEERING STEM BEARINGS



- Designed as a drop-in replacement to upgrade OEM ball-type bearings to taper bearings (where ball-type bearings are used by the OEM)
- Designed as a replacement taper bearing seat (where taper bearings are original equipment)
- Kits come complete with both upper and lower taper bearing cups and cones and seals (both top and bottom seals are included in most kits)
- Tapered roller bearings decrease maintenance along with less wear and longer life

FITS MODEL	PART #	SUG. RETAIL	FITS MODEL	PART #	SUG. RETAIL	FITS MODEL	PART #	SUG. RETAIL
VICTORY			VICTORY (CONT)			VICTORY (CONT)		
Boardwalk 13	0410-0192	\$37.29	Highball 12-13	0410-0192	\$37.29	Kingpin 09-12	0410-0192	\$37.29
Cross Country Cross Roads 10-13	0410-0192	\$7.29	Jackpot 06-07	22-1004	\$3.90	Vegas 03-05	22-1004	\$3.90
Hammer 05-08	22-1004	\$3.90	Jackpot 08-13	0410-0192	\$7.29	Vegas 8 Ball 06-07	22-1004	\$3.90
Hammer 09-13	0410-0192	\$7.29	Judge 12-13	0410-0192	\$7.29	Vegas 8 Ball 08-13	0410-0192	\$7.29
			Kingpin 04-08	22-1004	\$3.90	Vision 08-13	0410-0192	\$7.29



BRAIDED CONTROL CABLES

- The industry's highest-quality braid available in two color choices to complement your bike; Sterling Chromite II® and Black Pearl braided with black wire
- Braid color and weave match on all Magnum control cables and brake lines
- Crystal-clear outer jacket offers exceptional protection against scuffing paint or chrome and will never discolor
- All fittings are polished and chrome or black-chrome plated
- Low-effort, high-efficiency clutch cable design
- All cables are made with anti-friction inner liners and are factory lubricated for smooth, consistent, long-lasting operation
- Made in the U.S.A.



STERLING CHROMITE II

FITS MODEL	DESCRIPTION	OEM #	-2"	STOCK	+2"	+4"	+6"	+8"
VICTORY								
Cross Country 10-16 (w/ cruise), Cross Roads 10-14 (w/ cruise), Magnum/X-1 15-16 (w/ cruise)	Throttle Pull	7081309	-	0650-1620	0650-1621	0650-1635	0650-1636	0650-1637
	Throttle Push-Cruise	7081574	-	0650-1615	0650-1622	0650-1623	0650-1624	0650-1625
	Clutch	7081602	-	0652-2063	0652-2064	0652-2065	0652-2066	0652-2067
Cross Country, Cross Roads 10-11 (w/o cruise)	Throttle Pull	7081309	-	0650-1620	0650-1621	0650-1635	0650-1636	0650-1637
	Throttle Push	7081310	-	0651-0843	0651-0844	0651-0850	0651-0851	0651-0852
	Clutch	7081602	-	0652-2063	0652-2064	0652-2065	0652-2066	0652-2067
Boardwalk 14, Gunner 15-16, Hammer/S 08-16, Judge 14-15, Kingpin 08-12, Vegas 08-16 and Jackpot 08-16 (except 08-09 Ness)	Throttle Pull	7081452	-	0650-1614	0650-1618	0650-1619	0650-1620	0650-1621
	Throttle Push	7081448	-	0651-0839	0651-0841	0651-0842	0651-0843	0651-0844
	Clutch	7081600	-	0652-2035	0652-2041	0652-2042	0652-2043	0652-2044
Judge 13	Throttle Pull	7081793	-	0650-1634	0650-1614	0650-1618	0650-1619	0650-1620
	Throttle Push	7081792	-	0651-0849	0651-0839	0651-0841	0651-0842	0651-0843
	Clutch	7081600	-	0652-2035	0652-2041	0652-2042	0652-2043	0652-2044
Boardwalk 13, 15	Throttle Pull	7081452	-	0650-1614	0650-1618	0650-1619	0650-1620	0650-1621
	Throttle Push	7081448	-	0651-0839	0651-0841	0651-0842	0651-0843	0651-0844
	Clutch	7081727	-	0652-2041	0652-2042	0652-2043	0652-2044	0652-2063
Highball 12-16	Throttle Pull	7081729	-	0650-1619	0650-1620	0650-1621	0650-1635	-
	Throttle Push	7081728	-	0651-0842	0651-0843	0651-0844	0651-0850	-
	Clutch	7081727	-	0652-2041	0652-2042	0652-2043	0652-2044	0652-2063
Ness Jackpot 08-09	Throttle Pull	7081453	-	0650-1614	0650-1618	0650-1619	0650-1620	0650-1621
	Throttle Push	7081449	-	0651-0839	0651-0841	0651-0842	0651-0843	0651-0844
	Clutch	7081601	-	0652-2035	0652-2041	0652-2042	0652-2043	0652-2044
Octane 17	Clutch	7082099	0652-2068	0652-2037	0652-2049	0652-2050	0652-2051	-

BLACK PEARL

FITS MODEL	DESCRIPTION	OEM #	-2"	STOCK	+2"	+4"	+6"	+8"
VICTORY								
Cross Country 10-16 (w/ cruise), Cross Roads 10-14 (w/ cruise), Magnum/X-1 15-16 (w/ cruise)	Throttle Pull	7081309	-	0650-1628	0650-1629	0650-1639	0650-1640	0650-1641
	Throttle Push-Cruise	7081574	-	0650-1617	0650-1630	0650-1631	0650-1632	0650-1633
	Clutch	7081602	-	0652-2069	0652-2070	0652-2071	0652-2072	0652-2073
Cross Country, Cross Roads 10-11 (w/o cruise)	Throttle Pull	7081309	-	0650-1628	0650-1629	0650-1639	0650-1640	0650-1641
	Throttle Push	7081310	-	0651-0847	0651-0848	0651-0854	0651-0855	0651-0856
	Clutch	7081602	-	0652-2069	0652-2070	0652-2071	0652-2072	0652-2073
Boardwalk 14, Gunner 15-16, Hammer/S 08-16, Judge 14-15, Kingpin 08-12, Vegas 08-16 and Jackpot 08-16 (except 08-09 Ness)	Throttle Pull	7081452	-	0650-1616	0650-1626	0650-1627	0650-1628	0650-1629
	Throttle Push	7081448	-	0651-0840	0651-0845	0651-0846	0651-0847	0651-0848
	Clutch	7081600	-	0652-2038	0652-2052	0652-2053	0652-2054	0652-2055
Judge 13	Throttle Pull	7081793	-	0650-1638	0650-1616	0650-1626	0650-1627	0650-1628
	Throttle Push	7081792	-	0651-0853	0651-0840	0651-0845	0651-0846	0651-0847
	Clutch	7081600	-	0652-2038	0652-2052	0652-2053	0652-2054	0652-2055
Boardwalk 13, 15	Throttle Pull	7081452	-	0650-1616	0650-1626	0650-1627	0650-1628	0650-1629
	Throttle Push	7081448	-	0651-0840	0651-0845	0651-0846	0651-0847	0651-0848
	Clutch	7081727	-	0652-2052	0652-2053	0652-2054	0652-2055	0652-2069
Highball 12-16	Throttle Pull	7081729	-	0650-1627	0650-1628	0650-1629	0650-1639	-
	Throttle Push	7081728	-	0651-0846	0651-0847	0651-0848	0651-0854	-
	Clutch	7081727	-	0652-2052	0652-2053	0652-2054	0652-2055	0652-2069
Ness Jackpot 08-09	Throttle Pull	7081453	-	0650-1616	0650-1626	0650-1627	0650-1628	0650-1629
	Throttle Push	7081449	-	0651-0840	0651-0845	0651-0846	0651-0847	0651-0848
	Clutch	7081601	-	0652-2038	0652-2052	0652-2053	0652-2054	0652-2055
Octane 17	Clutch	7082099	0652-2074	0652-2040	0652-2060	0652-2061	0652-2062	-

PART #	SUG. RETAIL	PART #	SUG. RETAIL	PART #	SUG. RETAIL	PART #	SUG. RETAIL	PART #	SUG. RETAIL	PART #	SUG. RETAIL
0650-1614	\$59.95	0650-1627	\$59.95	0650-1640	\$59.95	0651-0850	\$59.95	0652-2043	\$104.95	0652-2064	\$104.95
0650-1615	79.95	0650-1628	59.95	0650-1641	59.95	0651-0851	59.95	0652-2044	104.95	0652-2065	104.95
0650-1616	59.95	0650-1629	59.95	0651-0839	59.95	0651-0852	59.95	0652-2049	85.95	0652-2066	104.95
0650-1617	79.95	0650-1630	79.95	0651-0840	59.95	0651-0853	59.95	0652-2050	85.95	0652-2067	104.95
0650-1618	59.95	0650-1631	79.95	0651-0841	59.95	0651-0854	59.95	0652-2051	85.95	0652-2068	85.95
0650-1619	59.95	0650-1632	79.95	0651-0842	59.95	0651-0855	59.95	0652-2052	104.95	0652-2069	104.95
0650-1620	59.95	0650-1633	79.95	0651-0843	59.95	0651-0856	59.95	0652-2053	104.95	0652-2070	104.95
0650-1621	59.95	0650-1634	59.95	0651-0844	59.95	0652-2035	104.95	0652-2054	104.95	0652-2071	104.95
0650-1622	79.95	0650-1635	59.95	0651-0845	59.95	0652-2037	85.95	0652-2055	104.95	0652-2072	104.95
0650-1623	79.95	0650-1636	59.95	0651-0846	59.95	0652-2038	104.95	0652-2060	85.95	0652-2073	104.95
0650-1624	79.95	0650-1637	59.95	0651-0847	59.95	0652-2040	85.95	0652-2061	85.95	0652-2074	85.95
0650-1625	79.95	0650-1638	59.95	0651-0848	59.95	0652-2041	104.95	0652-2062	85.95		
0650-1626	59.95	0650-1639	59.95	0651-0849	59.95	0652-2042	104.95	0652-2063	104.95		

All part numbers in **BOLD MAGENTA** are new this year.

VICTORY

EXHAUST

LUGGAGE

SECURITY

WINDSHIELDS

FAIRINGS & BODY

SEATS & Sissy BARS

HANDLEBARS & HAND CONTROLS

FOOTPEGS & FOOT CONTROLS

LIGHTING

ELECTRICAL

WHEELS & ACCESSORIES

BRAKES & SUSPENSION

ENGINE

FUEL/AIR SYSTEMS

INDIAN

EXHAUST

WINDSHIELDS

FAIRINGS & BODY

SEATS & Sissy BARS

HANDLEBARS & HAND CONTROLS

FOOTPEGS & FOOT CONTROLS

LIGHTING

ELECTRICAL

WHEELS & BRAKES

SUSPENSION

ENGINE

FUEL/AIR SYSTEMS

HANDLEBARS & HAND CONTROLS

VICTORY

EXHAUST

LUGGAGE

SECURITY

WINDSHIELDS

FAIRINGS & BODY

SEATS & Sissy BARS

HANDLEBARS & HAND CONTROLS

FOOTPEGS & FOOT CONTROLS

LIGHTING

ELECTRICAL

WHEELS & ACCESSORIES

BRAKES & SUSPENSION

ENGINE

FUEL/AIR SYSTEMS

INDIAN

EXHAUST

WINDSHIELDS

FAIRINGS & BODY

SEATS & Sissy BARS

HANDLEBARS & HAND CONTROLS

FOOTPEGS & FOOT CONTROLS

LIGHTING

ELECTRICAL

WHEELS & BRAKES

SUSPENSION

ENGINE

FUEL/AIR SYSTEMS



STAINLESS STEEL CABLES

- Barnett cables are smooth-working, long-lasting and made with the finest components available, making them virtually indestructible
- Stainless steel cables with clear coating offer that custom look without the fear of damaging areas that the cables come in contact with
- Available with standard nylon-lined, PVC-coated casings in standard diameters
- Made in the U.S.A.

FITS MODEL	DESCRIPTION	STAINLESS STEEL PART #	SUG. RETAIL	BLACK VINYL PART #	SUG. RETAIL
VICTORY					
Boardwalk 13	Throttle Pull	0650-1551	\$54.95	0650-1541	\$52.95
	Throttle Pull (+6")	0650-1556	64.95	0650-1546	52.95
	Throttle Push	0651-0815	54.95	0651-0801	52.95
	Throttle Push (+6")	0651-0822	64.95	0651-0808	52.95
	Clutch	0652-1960	96.95	0652-1948	80.95
	Clutch (+6")	0652-1966	99.95	0652-1954	80.95
Boardwalk 14-15	Throttle Pull	0650-1551	54.95	0650-1541	52.95
	Throttle Pull (+6")	0650-1556	64.95	0650-1546	52.95
	Throttle Push	0651-0815	54.95	0651-0801	52.95
	Throttle Push (+6")	0651-0822	64.95	0651-0808	52.95
	Clutch	0652-1961	96.95	0652-1949	80.95
	Clutch (+6")	0652-1967	99.95	0652-1955	80.95
Cross Country/Touring w/ cruise control 10-16	Throttle Pull	0650-1552	54.95	0650-1542	52.95
	Throttle Pull (+6")	0650-1557	64.95	0650-1547	52.95
	Throttle Push-Cruise	0651-0819	79.95	0651-0805	75.95
	Throttle Push-Cruise (+6")	0651-0826	95.95	0651-0812	75.95
	Clutch	0652-1959	96.95	0652-1947	80.95
	Clutch (+6")	0652-1965	99.95	0652-1953	80.95
Cross Roads 10-16	Throttle Pull	0650-1552	54.95	0650-1542	52.95
	Throttle Pull (+6")	0650-1557	64.95	0650-1547	52.95
	Throttle Push	0651-0816	54.95	0651-0802	52.95
	Throttle Push (+6")	0651-0823	64.95	0651-0809	52.95
	Clutch	0652-1959	96.95	0652-1947	80.95
	Clutch (+6")	0652-1965	99.95	0652-1953	80.95
Gunner 15-16	Throttle Pull	0650-1551	54.95	0650-1541	52.95
	Throttle Pull (+6")	0650-1556	64.95	0650-1546	52.95
	Throttle Push	0651-0815	54.95	0651-0801	52.95
	Throttle Push (+6")	0651-0822	64.95	0651-0808	52.95
	Clutch	0652-1961	96.95	0652-1949	80.95
	Clutch (+6")	0652-1967	99.95	0652-1955	80.95
Hammer 05-07, Kingpin 04-07, Vegas 03-07, 8-Ball 06-07	Throttle Pull	0650-1550	54.95	0650-1540	52.95
	Throttle Pull (+6")	0650-1555	64.95	0650-1545	52.95
	Throttle Push	0651-0814	54.95	0651-0800	52.95
	Throttle Push (+6")	0651-0821	64.95	0651-0807	52.95
	Clutch	0652-1957	96.95	0652-1945	80.95
	Clutch (+6")	0652-1963	99.95	0652-1951	80.95
Hammer, Kingpin, Vegas/8-Ball 08-09	Throttle Pull	0650-1551	54.95	0650-1541	52.95
	Throttle Pull (+6")	0650-1556	64.95	0650-1546	52.95
	Throttle Push	0651-0815	54.95	0651-0801	52.95
	Throttle Push (+6")	0651-0822	64.95	0651-0808	52.95
	Clutch	0652-1958	96.95	0652-1946	80.95
	Clutch (+6")	0652-1964	99.95	0652-1952	80.95

FITS MODEL	DESCRIPTION	STAINLESS STEEL PART #	SUG. RETAIL	BLACK VINYL PART #	SUG. RETAIL
VICTORY (CONT)					
Hammer 10-16	Throttle Pull	0650-1551	54.95	0650-1541	52.95
	Throttle Pull (+6")	0650-1556	64.95	0650-1546	52.95
	Throttle Push	0651-0815	54.95	0651-0801	52.95
	Throttle Push (+6")	0651-0822	64.95	0651-0808	52.95
	Clutch	0652-1961	96.95	0652-1949	80.95
	Clutch (+6")	0652-1967	99.95	0652-1955	80.95
Highball 12-16	Throttle Pull	0650-1553	54.95	0650-1543	52.95
	Throttle Pull (+6")	0650-1558	64.95	0650-1548	52.95
	Throttle Push	0651-0817	54.95	0651-0803	52.95
	Throttle Push (+6")	0651-0824	64.95	0651-0810	52.95
	Clutch	0652-1960	96.95	0652-1948	80.95
	Clutch (+6")	0652-1966	99.95	0652-1954	80.95
Judge 13	Throttle Pull	0650-1554	54.95	0650-1544	52.95
	Throttle Pull (+6")	0650-1559	64.95	0650-1549	52.95
	Throttle Push	0651-0818	54.95	0651-0804	52.95
	Throttle Push (+6")	0651-0825	64.95	0651-0811	52.95
	Clutch	0652-1961	96.95	0652-1949	80.95
	Clutch (+6")	0652-1967	99.95	0652-1955	80.95
Judge 14, Kingpin 10-13, Vegas 10-14, Vegas Jackpot 11-14, Vegas 8-Ball 10-13	Throttle Pull	0650-1551	54.95	0650-1541	52.95
	Throttle Pull (+6")	0650-1556	64.95	0650-1546	52.95
	Throttle Push	0651-0815	54.95	0651-0801	52.95
	Throttle Push (+6")	0651-0822	64.95	0651-0808	52.95
	Clutch	0652-1961	96.95	0652-1949	80.95
	Clutch (+6")	0652-1967	99.95	0652-1955	80.95
Vegas Jackpot 10	Throttle Pull	0650-1551	54.95	0650-1541	52.95
	Throttle Pull (+6")	0650-1556	64.95	0650-1546	52.95
	Throttle Push	0651-0815	54.95	0651-0801	52.95
	Throttle Push (+6")	0651-0822	64.95	0651-0808	52.95
	Clutch	0652-1962	96.95	0652-1950	80.95
	Clutch (+6")	0652-1968	99.95	0652-1956	80.95
Vision (w/ cruise control) 09-16	Throttle Pull	0650-1552	54.95	0650-1542	52.95
	Throttle Pull (+6")	0650-1557	64.95	0650-1547	52.95
	Throttle Push-Cruise	0651-0820	79.95	0651-0806	75.95
	Throttle Push-Cruise (+6")	0651-0827	95.95	0651-0813	75.95
	Clutch	0652-1959	96.95	0652-1947	80.95
	Clutch (+6")	0652-1965	99.95	0652-1953	80.95



**iOmounts™
DEVICE MOUNTS
FOR VICTORY CROSS COUNTRY,
CROSS COUNTRY TOUR
W/ STOCK CONTROLS 10-16**

- Motorcycle model-specific mounts incorporate the iOmounts™ system; install the mount to bike with included hardware
- Nomad Universal mount fits any handlebars that are .5" to 2" in diameter; includes Nomad, two iOadapts and two iOskins
- Attach razor-thin iOadapt stainless steel adapter to your device and connect to the powerful iOcore magnetic carrier
- Device is held in place by the strong iOcore magnet, and you can adjust the angle of your device
- iOskin provides perfect surface to mount iOadapt, and protects device from iOadapt adhesive

NOTE: Not for use with Samsung Galaxy S4 phones.

COLOR	PART #	SUG. RETAIL
MODEL-SPECIFIC PERCH MOUNTS		
Chrome	0636-0051	\$99.95
Black	0636-0052	99.95
DESCRIPTION	PART #	SUG. RETAIL
OPTIONAL MAGNETIC IOCORE		
Green iOcore	0636-0037	\$19.95
Black iOcore	0636-0038	19.95
Blue iOcore	0636-0039	19.95
Gray iOcore	0636-0040	19.95
Orange iOcore	0636-0041	19.95
Pink iOcore	0636-0042	19.95



COLOR	PART #	SUG. RETAIL
UNIVERSAL MOUNTS		
Nomad	0636-0055	\$59.95
DESCRIPTION	PART #	SUG. RETAIL
OPTIONAL MAGNETIC IOCORE (CONT)		
Red iOcore	0636-0043	\$19.95
Yellow iOcore	0636-0044	19.95
REPLACEMENT COMPONENTS (EA.)		
iOskin	0636-0046	4.95
iOadapt disc	0636-0045	9.95



**GADGET BAR AND MOUNT
FOR ALL VICTORY
(EXCEPT VISION 99-16)**

- Includes 7/8" dia. x 4 1/2" gadget bar and mounting hardware
- For 7/8" and 1" handlebars

SUG. RETAIL\$39.95
PART # **0636-0081**



**HANDLEBAR PHONE HOLDER
FOR ALL VICTORY
(EXCEPT VISION 99-16)**

- Keeps your phone handy
- Phone and GPS holder and universal mount for 7/8" to 1" handlebars
- Hardware included

SUG. RETAIL\$59.95
PART # **0636-0080**



**HANDLEBAR BEVERAGE HOLDER
FOR ALL VICTORY
(EXCEPT VISION 99-16)**

- Keeps your favorite beverage within reach
- Universal mount to any 7/8" or 1" handlebar

SUG. RETAIL\$39.95
PART # **0636-0079**

All part numbers in **BOLD MAGENTA** are new this year.

Accutronix
precision crafted billet products

VICTORY

EXHAUST

LUGGAGE

SECURITY

WINDSHIELDS

FAIRINGS & BODY

SEATS & Sissy BARS

HANDLEBARS & HAND CONTROLS

FOOTPEGS & FOOT CONTROLS

LIGHTING

ELECTRICAL

WHEELS & ACCESSORIES

BRAKES & SUSPENSION

ENGINE

FUEL/AIR SYSTEMS

INDIAN

EXHAUST

WINDSHIELDS

FAIRINGS & BODY

SEATS & Sissy BARS

HANDLEBARS & HAND CONTROLS

FOOTPEGS & FOOT CONTROLS

LIGHTING

ELECTRICAL

WHEELS & BRAKES

SUSPENSION

ENGINE

FUEL/AIR SYSTEMS

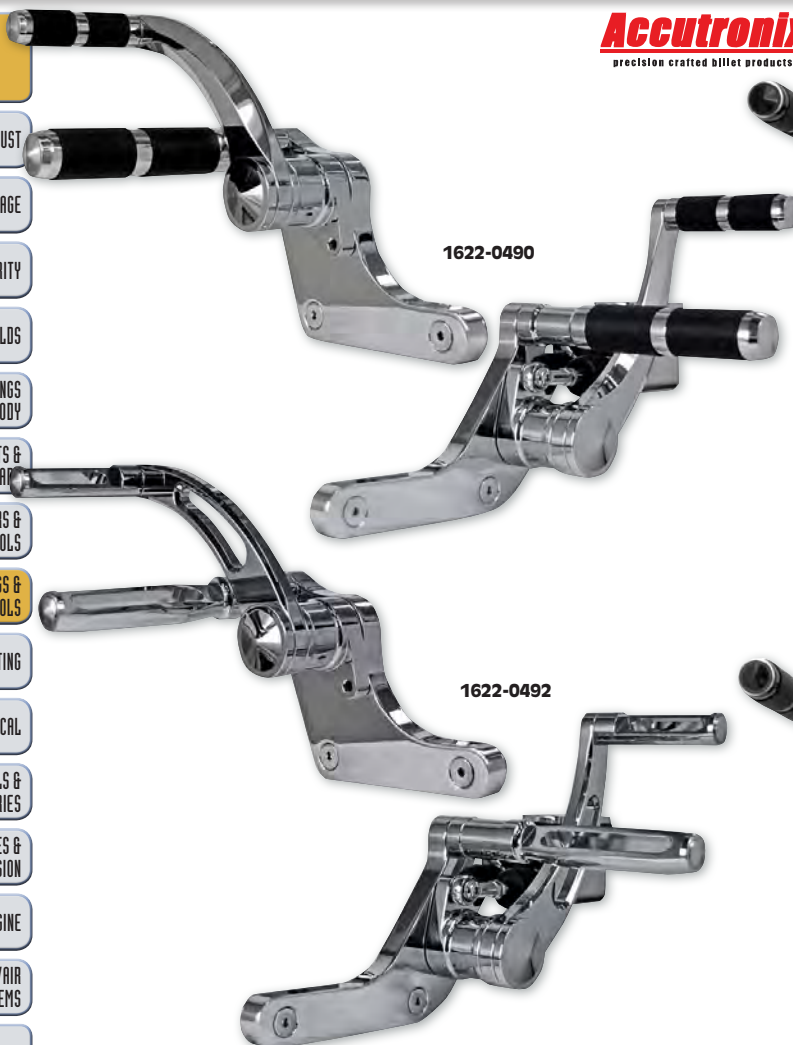

**FORWARD CONTROL KITS
FOR VICTORY GUNNER/HAMMER/HIGH BALL/
JACKPOT/JUDGE/VEGAS/8-BALL**

- Machined from 6061-T6 billet aluminum
- Assembled with chrome-plated hardware and come ready to install
- Include master cylinder, shift linkage, footpegs and shift peg
- Made in the U.S.A.

NOTE: Some models may require custom rear brake line.

SUG. RETAIL\$942.95

DESCRIPTION	PART #	DESCRIPTION	PART #
Diamond, chrome	1622-0490	Slotted, chrome	1622-0492
Diamond, black anodized	1622-0491	Slotted, black anodized	1622-0493

**+4" FORWARD CONTROL EXTENSION KIT
FOR VICTORY GUNNER/HAMMER/HIGH BALL/
JACKPOT/JUDGE/KINGPIN/VEGAS**

- Moves Victory OEM forward controls 4" forward from stock location for more legroom
- Machined from 6061-T6 billet aluminum and powder-coated gloss
- Shift rods and mounting hardware made from stainless steel
- Made in the U.S.A.

SUG. RETAIL\$199.95



PART #	PART #
	1622-0520

KURYAKYN 

1621-0088



1621-0144



ISO® DRIVER AND PASSENGER FLOORBOARDS WITH SPLINED ADAPTER MOUNTS

- Kits include our chromed ISO®-Boards with full-length rubber inserts and a cast bracket to connect with Kuryakyn's splined adapter mounts (sold separately)
- Floorboards measure approximately 9¹/₈" long
- Passenger peg-only bracket positions the floorboards 1" higher than the stock footpeg height
- Sold in pairs

NOTE: Requires Kuryakyn bike-specific splined adapter mounts for installation (sold separately; see below).

DESCRIPTION	PART #	SUG. RETAIL	DESCRIPTION	PART #	SUG. RETAIL
Driver floorboards	1621-0088	\$199.99	Passenger floorboards	1621-0144	\$219.99

GLOSS BLACK ISO®-WINGS MINI FLOORBOARDS

- An attractive alternative to footpegs
- Size provides more support than OEM footpegs, yet the stylish design remains unobtrusive
- Boards without male-mount ends require the use of Kuryakyn footpeg adapters, see page 54
- Sold in pairs

SUG. RETAIL \$99.99 PART # **1620-1085**



SPLINED PASSENGER BOARD MOUNT ADAPTER FOR CROSS COUNTRY TOUR 10-16

- Designed to attach to OEM passenger board mounts on models with OEM passenger boards to allow installation of Kuryakyn floorboards or footpegs that accept splined adapters
- Sold in pairs

SUG. RETAIL \$34.99 PART # **1621-0708**



KINETIC™ FLOORBOARD INSERTS FOR CROSS COUNTRY/CROSS COUNTRY TOUR/MAGNUM 10-16, CROSS ROADS 10-14 AND HARD BALL 12-13

- Raised front toe kick delivers extra level of comfort for those long days on the road
- Direct replacement for OEM floorboard inserts
- Sold in pairs

SUG. RETAIL \$189.99

DESCRIPTION	PART #
Chrome	1621-0616
Gloss black	1621-0617

1621-0616



VICTORY

EXHAUST

LUGGAGE

SECURITY

WINDSHIELDS

FAIRINGS & BODY

SEATS & Sissy BARS

HANDLEBARS & HAND CONTROLS

FOOTPEGS & FOOT CONTROLS

LIGHTING

ELECTRICAL

WHEELS & ACCESSORIES

BRAKES & SUSPENSION

ENGINE

FUEL/AIR SYSTEMS

INDIAN

EXHAUST

WINDSHIELDS

FAIRINGS & BODY

SEATS & Sissy BARS

HANDLEBARS & HAND CONTROLS

FOOTPEGS & FOOT CONTROLS

LIGHTING

ELECTRICAL

WHEELS & BRAKES

SUSPENSION

ENGINE

FUEL/AIR SYSTEMS

All part numbers in **BOLD MAGENTA** are new this year.

VICTORY

EXHAUST

LUGGAGE

SECURITY

WINDSHIELDS

FAIRINGS & BODY

SEATS & Sissy BARS

HANDLEBARS & HAND CONTROLS

FOOTPEGS & FOOT CONTROLS

LIGHTING

ELECTRICAL

WHEELS & ACCESSORIES

BRAKES & SUSPENSION

ENGINE

FUEL/AIR SYSTEMS

INDIAN

EXHAUST

WINDSHIELDS

FAIRINGS & BODY

SEATS & Sissy BARS

HANDLEBARS & HAND CONTROLS

FOOTPEGS & FOOT CONTROLS

LIGHTING

ELECTRICAL

WHEELS & BRAKES

SUSPENSION

ENGINE

FUEL/AIR SYSTEMS

RETRACTABLE PASSENGER CRUISE PEGS FOR VICTORY CROSS COUNTRY, CROSS ROADS AND HARBALL WITH OEM FOOTPEG MOUNTS 10-16 (EXCEPT CROSS COUNTRY TOUR)

- Let your passenger stretch their legs
- Innovative cruise pegs rotate forward for an alternate foot position during those long cruises and rotate out of the way when not needed
- Include small Trident ISO®-Pegs
- Mount to OEM passenger footpeg mount; can be used with either existing stock passenger pegs or coordinate with any Kuryakyn pegs or floorboards
- Sold in pairs

SUG. RETAIL \$219.99

PART #

1620-1312



TOE-REST CRUISE PEGS FOR VICTORY MODELS WITH 1 1/4" ENGINE GUARDS

- Minimalist toe rest mounts attach directly to engine guard to allow heel to sit on floorboard with front of foot resting just behind engine guard
- Fit stock 1 1/4" round engine guards
- Sold in pairs

SUG. RETAIL \$99.99

PART #

1624-0309



ISO®-PEGS

- Give you a custom look and dampen vibration
- Hollow-core neoprene inserts are long lasting
- Small peg measures 1 1/4" in diameter x 4 5/8" long
- Large peg measures 1 1/2" in diameter x 4 7/8" long
- Dually peg measures 2 1/2" wide x 5" long
- Pegs without male-mount ends require the use of Kuryakyn footpeg adapters, see page 54
- Sold in pairs

DESCRIPTION	PART #	SUG. RETAIL
Small ISO®-Pegs w/o male-mount ends	1620-0157	\$39.99
Large ISO-Pegs w/o male-mount ends	1620-0158	39.99

DESCRIPTION	PART #	SUG. RETAIL
Dually ISO-Pegs w/o male-mount ends	1620-0159	\$69.99

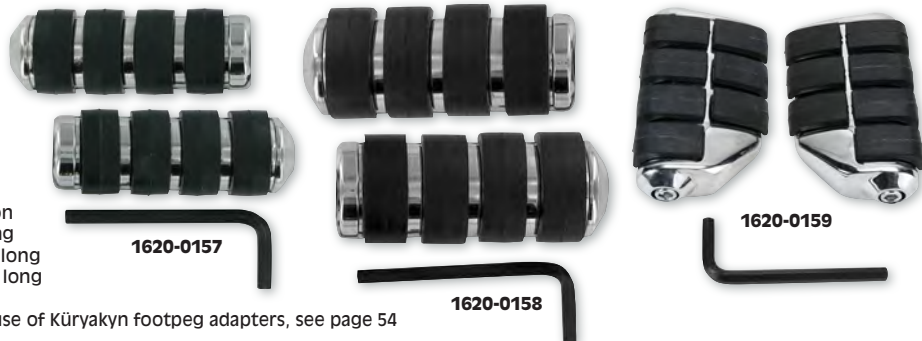

TRIDENT ISO®-PEGS

- An updated design of the original ISO®-Pegs
- Look great with stock or custom footrests
- Footpegs without male-mount ends require the use of Kuryakyn footpeg adapters, see page 54
- All styles sold in pairs

DESCRIPTION	PART #	SUG. RETAIL
CHROME		
Small Trident pegs (4 5/8" x 1 1/4") w/o male-mount ends	1620-0923	\$39.99
Large Trident pegs (4 7/8" x 1 1/2") w/o male-mount ends	1620-0924	39.99
Dually Trident pegs (4 1/2" x 1 1/4") w/o male-mount ends	1620-0925	69.99

DESCRIPTION	PART #	SUG. RETAIL
GLOSS BLACK		
Small Trident pegs w/o male-mount ends	1620-1082	\$39.99
Large Trident pegs w/o male-mount ends	1620-1083	39.99
Dually Trident pegs w/o male-mount ends	1620-1084	69.99



ISO®-SWEPTWING PEGS

- Simple, stylish design adds a sleek, streamlined look to your bike
- Feature the traditional ISO® design to reduce vibration and provide long-distance comfort
- Pegs without male-mount ends require Kuryakyn footpeg adapters, see page 54
- Sold in pairs

SUG. RETAIL \$69.99

PART #

1620-0370

KURYAKYN 



SWINGWING PEGS

- A convenient alternative to forward controls
- Our clever cruise peg features a fold-forward design
- Secondary fold-out peg extends 3" forward and locks into place for added legroom and comfort
- Pegs without male-mount ends require the use of Kuryakyn splined footpeg adapters, see page 54
- Sold in pairs

SUG. RETAIL **\$159.99** **PART #** 1620-0423



FLAMIN' SWITCHBLADE PEGS

- Flip-out heel rest adds comfort
- Heel rests have curb feeler tabs underneath
- Flip-out arm is designed only to be used as a heel rest
- Available without male-mount ends
- Pegs without male-mount ends require male-mount footpeg adapters

SUG. RETAIL **\$159.99** **PART #** 1620-1145



ZOMBIE™ PEGS

- Features a sinister spire point and a skull nestled between the rubber pads
- Sturdy, rugged design
- Pegs without male-mount ends require Kuryakyn footpeg adapters, see page 54
- Sold in pairs

SUG. RETAIL **\$109.99** **PART #** 1620-0278



WIDOW PEGS

- Full custom footpeg design
- Ominous black widow design nestled in the rubber pads
- Footpegs without male-mount ends require the use of Kuryakyn footpeg adapters, see page 54
- Sold in pairs

SUG. RETAIL **\$99.99** **PART #** 1611-0016



KINETIC SHIFT AND BRAKE PEG

- Shift through gears or stop on a dime in style
- Direct replacement and includes a 3/8" spacer to adjust the position during installation

SUG. RETAIL **\$34.99**

DESCRIPTION	PART #
CROSS COUNTRY/TOUR/MAGNUM 10-16, CROSS ROADS 10-14, BOARDWALK 13-14, HARD BALL 12-15, KINGPIN 04-12, OCTANE 17, VISION 08-16	
Chrome	1602-1044
Gloss black	1602-1045



BRAKE PEDAL PAD COVER

- Clamshell design has a chrome finish with rubber inserts
- Installs over stock rubber pad; secures with two setscrews

SUG. RETAIL **\$29.99** **PART #** 1611-0035

FITS MODEL
VICTORY
V92C, V92TC, V92DC (all), Hammer/S 09-14, Jackpot 09-14, Kingpin Low 09-14, Ness Jackpot 09-14

VICTORY

EXHAUST

LUGGAGE

SECURITY

WINDSHIELDS

FAIRINGS & BODY

SEATS & Sissy BARS

HANDLEBARS & HAND CONTROLS

FOOTPEGS & FOOT CONTROLS

LIGHTING

ELECTRICAL

WHEELS & ACCESSORIES

BRAKES & SUSPENSION

ENGINE

FUEL/AIR SYSTEMS

INDIAN

EXHAUST

WINDSHIELDS

FAIRINGS & BODY

SEATS & Sissy BARS

HANDLEBARS & HAND CONTROLS

FOOTPEGS & FOOT CONTROLS

LIGHTING

ELECTRICAL

WHEELS & BRAKES

SUSPENSION

ENGINE

FUEL/AIR SYSTEMS

All part numbers in **BOLD MAGENTA** are new this year.

VICTORY

KURYAKYN FOOTPEG ADAPTERS

- For use with Kuryakyn footpegs and floorboards that do not have male-mount ends
- Beautiful chrome finish
- Rider and passenger peg adapters available
- If additional mounting hardware is necessary, it is included with adapters
- Sold in pairs

SUG. RETAIL \$26.99



FITS MODEL	FRONT	REAR
VICTORY		
Boardwalk (all)	-	1620-1140
Cross Country (all)	-	1620-1140
Cross Roads (all)	-	1620-1140
Gunner (all)	1620-1140	1620-1140 ¹
Hammer (all)	1620-1140	1620-1140
Hard Ball (all)	-	1620-1140

FITS MODEL	FRONT	REAR
VICTORY (CONT)		
High Ball (all)	1620-1140	-
Judge (all)	1620-1140	1620-1140
Kingpin (all)	-	1620-1140 ¹
Octane	1620-1557	1620-1140 ¹
Vegas/8-Ball/Jackpot (all)	1620-1140	1620-1140

¹ Must use accessory peg mounts from Victory.

EXHAUST

LUGGAGE

SECURITY

WINDSHIELDS

FAIRINGS & BODY

SEATS & SISSY BARS

HANDLEBARS & HAND CONTROLS

FOOTPEGS & FOOT CONTROLS

LIGHTING

ELECTRICAL

WHEELS & ACCESSORIES

BRAKES & SUSPENSION

ENGINE

FUEL/AIR SYSTEMS

INDIAN

EXHAUST

WINDSHIELDS

FAIRINGS & BODY

SEATS & SISSY BARS

HANDLEBARS & HAND CONTROLS

FOOTPEGS & FOOT CONTROLS

LIGHTING

ELECTRICAL

WHEELS & BRAKES

SUSPENSION

ENGINE

FUEL/AIR SYSTEMS

KURYAKYN SPLINED ADAPTER MOUNTS

- Provide slip-free mounting of Kuryakyn ISO®-Boards™ and other Kuryakyn footpeg and foot control accessories that require splined peg adapter mounts
- Designed for use with the OEM footpeg mount
- Sold in pairs

SUG. RETAIL \$26.99



FITS MODEL	FRONT PART #	REAR PART #
VICTORY		
Cross Country (all)	-	1620-0724
Cross Roads (all)	-	1620-0724
Gunner (all)	-	1620-0724 ¹
Hard Ball (all)	-	1620-0724
Hammer (all)	-	1620-0724

FITS MODEL	FRONT PART #	REAR PART #
VICTORY (CONT)		
Kingpin (all)	-	1620-0724 ¹
Octane	1620-1558	1620-0724 ¹
Vegas, 8-Ball, Jackpot (all)	1620-0724	1620-0724

¹ Must use accessory peg mounts from Victory.

BAHN ADAPTER PEGS

- Feature a flattened top and coordinating end caps
- Forged from machined aluminum
- Engineered for increased surface area coverage and better boot placement
- Soft rubber inserts provide reduced vibration for a seamless blend of unmatched style and function
- Available in tuxedo black or chrome
- Made in the U.S.A.

SUG. RETAIL \$139.99

DESCRIPTION	DESCRIPTION	PART #
Tuxedo	Universal fitment for all Kuryakyn male mount footpeg clevises	1620-1560
Chrome	Typical male mount for cruise peg applications	1620-1561



SHIFTER PEGS

- Constructed of 6061 T-6 billet aluminum
- Install using 5/16"-24 stud
- Pyramid rubber for added traction
- Available with chrome or black-anodized finish
- Matches CBD floorboards
- Easy to install
- Made in the U.S.A.



CARL BROUHARD DESIGNS LLC

SUG. RETAIL \$73.95

DESCRIPTION	PART #	DESCRIPTION	PART #
Black	1603-0134	Chrome	1603-0135



SHO CHROME ACCESSORIES BRAKE PEDAL PAD KIT FOR VICTORY BOARDWALK 13-14, CROSS COUNTRY 10-16, CROSS ROADS 10-13, KINGPIN 08-12, MAGNUM 15-16, VEGAS 07-09, VISION 08-16

- Adds new style to your Victory ride
- Durable rubber pad inserts
- Includes hardware

SUG. RETAIL \$45.95 PART #



1611-0067

LINDBY
CUSTOM, INC.
metric

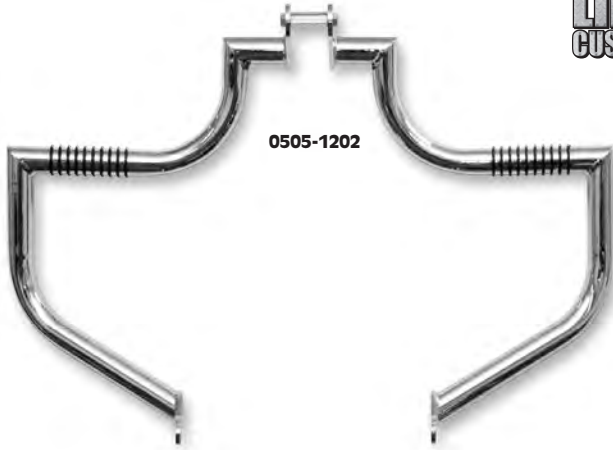

0505-1202

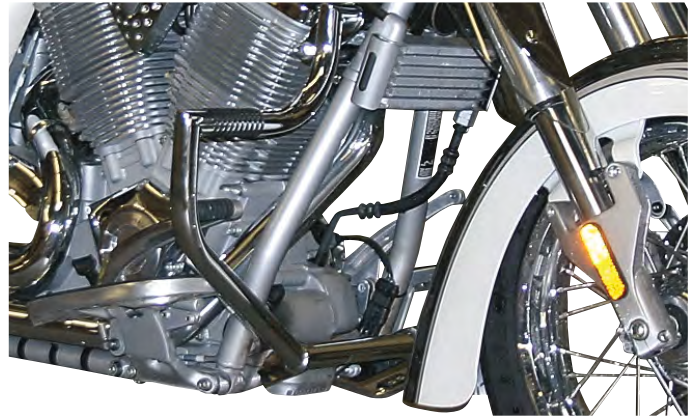

1624-0042

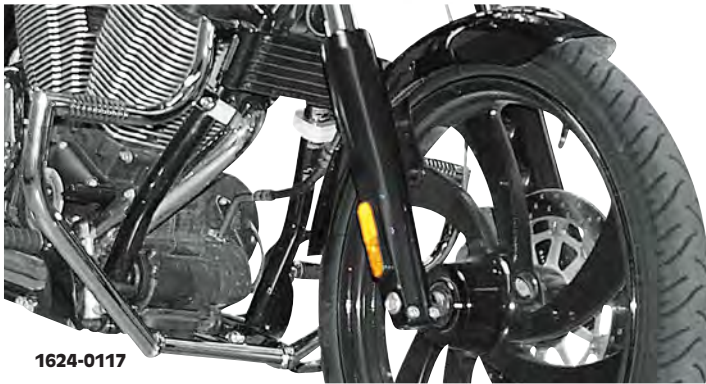

1624-0117

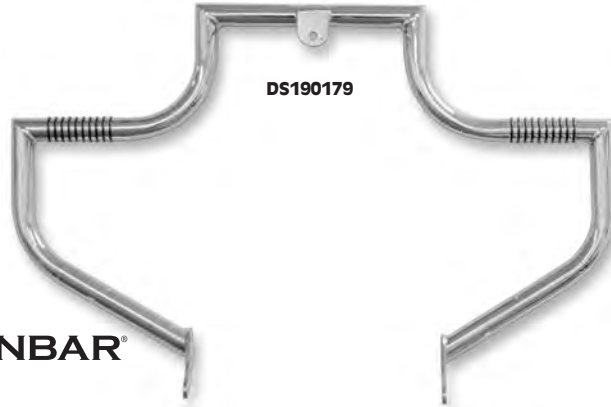

DS190179

LINBAR® FRONT HIGHWAY BARS THE LINBAR®

- Made from 1 1/4" high-strength steel that has a triple-chrome-plated finish for long-lasting durability
- Precision bent and welded for a perfect fit every time
- Neoprene O-rings provide traction in all climates

U.S. Patent #D361311.

NOTE: Not recommended for use with extended forward controls or extended floorboards.

SUG. RETAIL \$369.95

FITS MODEL	PART #	FITS MODEL	PART #
VICTORY		VICTORY (CONT)	
Cross Country, Cross Roads, Hardball, Magnum 10-16	0505-1202	Kingpin, Vegas, Jackpot, 8 Ball, Hammer, Boardwalk, Judge, Highball 06-16	1624-0117
Kingpin/Vegas 03-05	1624-0042	V92C 98-01	DS190179

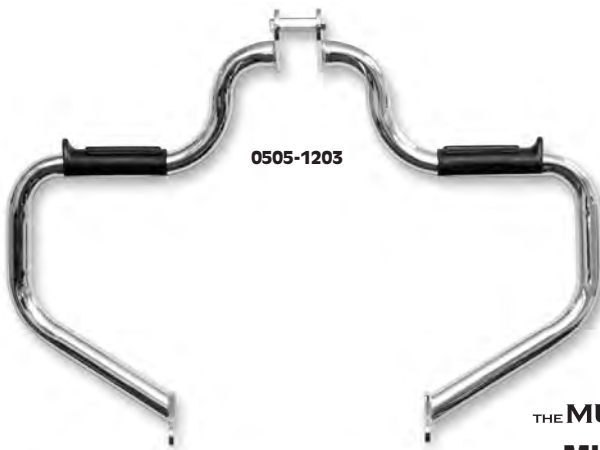

0505-1203



1624-0168

THE MULTIBAR® MULTIBAR®

- Made from a single piece of 1 1/4" diameter high-strength steel that has been triple-chrome-plated or powder-coated black for long-lasting durability
- Precision bent
- Built-in bonded rubber footrests that provide traction and allow riders to adjust their position
- Easily installed with included hardware

U.S. Patent #D578142.

SUG. RETAIL \$289.95

FITS MODEL	FINISH	PART #
VICTORY		
Cross Country, Cross Roads, Hardball, Magnum 10-16	Chrome-plated	0505-1203
	Black powder-coated	0505-1204
Kingpin, Vegas, Jackpot, 8 Ball, Hammer, Boardwalk, Judge, Highball 06-16	Chrome-plated	1624-0141
	Black powder-coated	1624-0168

All part numbers in **BOLD MAGENTA** are new this year.

VICTORY

EXHAUST

LUGGAGE

SECURITY

WINDSHIELDS

FAIRINGS & BODY

SEATS & Sissy BARS

HANDLEBARS & HAND CONTROLS

FOOTPEGS & FOOT CONTROLS

LIGHTING

ELECTRICAL

WHEELS & ACCESSORIES

BRAKES & SUSPENSION

ENGINE

FUEL/AIR SYSTEMS

INDIAN

EXHAUST

WINDSHIELDS

FAIRINGS & BODY

SEATS & Sissy BARS

HANDLEBARS & HAND CONTROLS

FOOTPEGS & FOOT CONTROLS

LIGHTING

ELECTRICAL

WHEELS & BRAKES

SUSPENSION

ENGINE

FUEL/AIR SYSTEMS

VICTORY

EXHAUST

LUGGAGE

SECURITY

WINDSHIELDS

FAIRINGS & BODY

SEATS & Sissy BARS

HANDLEBARS & HAND CONTROLS

FOOTPEGS & FOOT CONTROLS

LIGHTING

ELECTRICAL

WHEELS & ACCESSORIES

BRAKES & SUSPENSION

ENGINE

FUEL/AIR SYSTEMS

INDIAN

EXHAUST

WINDSHIELDS

FAIRINGS & BODY

SEATS & Sissy BARS

HANDLEBARS & HAND CONTROLS

FOOTPEGS & FOOT CONTROLS

LIGHTING

ELECTRICAL

WHEELS & BRAKES

SUSPENSION

ENGINE

FUEL/AIR SYSTEMS



HIGHWAY BAR RAIN GUARDS

- Designed to help keep rain and road debris off your boots and lower legs
- Produce minimal wind resistance and do not affect airflow to the motor
- Sold as a set
- For Cobra® Standard Freeway or Fatty bars, see page 681 of the PU Street book
- Made in the U.S.A.

FITS MODEL	DESCRIPTION	PART #	SUG. RETAIL
VICTORY			
Cross Country/ Cross Roads 10-16	Black	1624-0314	\$130.95

FITS MODEL	DESCRIPTION	PART #	SUG. RETAIL
VICTORY (CONT)			
Hard Ball 13	Black	1624-0314	\$130.95
Magnum 15-16	Black	1624-0314	130.95

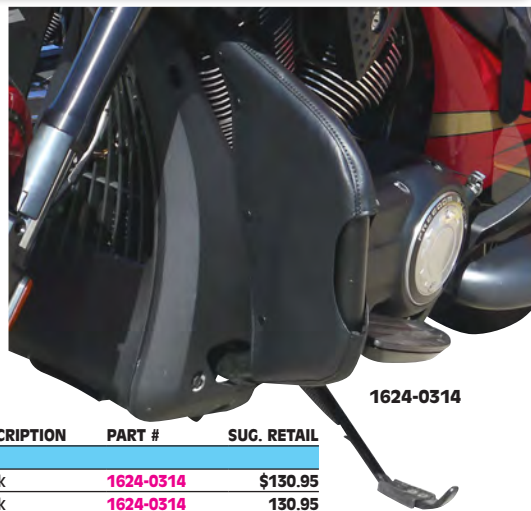

1624-0314



BLACK CLASSIC PAC-A-DERMS™ FOR VICTORY FORGED BARS ON CROSS COUNTRY, CROSS ROADS AND MAGNUM MODELS 10-16 (ALL)

- Front engine guard covers block wind and water spray
- Includes a pair of Black Classic EZ Mount™ removable pouches
- No tools required to install; securely attach with custom hold snaps to wrap around the highway bars
- Made in the U.S.A.

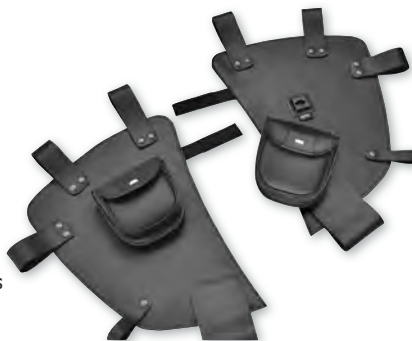

SUG. RETAIL **\$119.95** PART # **1624-0315**



1601-0403



1601-0422

ELECTRIC EASY SHIFT SPEED SHIFTER KITS



- Easy shifting for rider comfort and convenience or for speed for the performance-oriented rider
- For performance, this is the best bang-for-your-buck product
- Gain a minimum of one bike length per shift
- Shift up at partial or full throttle and back down with the push of a button
- Eliminate the need to shift with your foot or clutch
- OEM shifting ability is retained after installation
- Clutch use is still required for starting and stopping when using these kits
- Use state-of-the-art control module to send a signal from the button control to the shift solenoid
- Kits include a stylish dual-button shift control for upshifts/downshifts, a chrome-plated electronic shift cylinder, ignition kill module, control modules and all necessary brackets
- Made in the U.S.A.



1601-0468

FITS MODEL	PART #	SUG. RETAIL
VICTORY		
Cross Country/Cross Roads 10	1601-0403	\$1,155.95
Cross Country/Cross Roads 11-14	1601-0422	1,155.95
Hammer 09-14	1601-0468	1,210.95
Hard-Ball 11-14	1601-0422	1,155.95
Jackpot 09-15	1601-0468	1,210.95

FITS MODEL	PART #	SUG. RETAIL
VICTORY (CONT)		
Kingpin/Touring 09	1601-0468	\$1,210.95
Vegas/Vegas 8 Ball 09	1601-0468	1,210.95
Vision 08-10	1601-0403	1,155.95
Vision 11-14	1601-0422	1,155.95



TURN SIGNALS WITH DAYTIME RUNNING LIGHTS (DRL)

- T 6061 billet aluminum housings in chrome or gloss black finish
- 15 super-bright White Daytime Running Light (DRL) LEDs per side
- 15 super-bright Amber Turn Signal LEDs per side
- Available with smoke lens
- Available for: 39mm, 41mm, 43mm, 49mm and 56mm forks

DESCRIPTION	CHROME	BLACK	DESCRIPTION	CHROME	BLACK
39mm	2020-1281	2020-1280	49mm	2020-1287	2020-1286
41mm	2020-1283	2020-1282	56mm	2020-1289	2020-1288
43mm	2020-1285	2020-1284			

SUG. RETAIL \$279.95



WRAP-AROUND LED MARKER LIGHTS

- Each light has 30 super-bright amber LEDs
- Clear or smoke lens available
- Housings are 6061 billet aluminum with a chrome or gloss black finish
- Order based on outside diameter of the fork tubes; see chart
- Sold in pairs
- Made in the U.S.A.

NOTE: Load equalizer may be required.

SUG. RETAIL \$259.95

DESCRIPTION	LENS	PART #	DESCRIPTION	LENS	PART #
43MM					
Chrome	Clear	2020-1218	Chrome	Clear	2020-1226
	Smoke	2020-1219		Smoke	2020-1227
56MM					
Black	Clear	2020-1220	Black	Clear	2020-1228
	Smoke	2020-1221		Smoke	2020-1229

REAR LED TURN SIGNALS

- Feature super-bright LEDs
- Choice of red or amber LEDs with red, clear, light smoke or dark smoke lens
- Bolt-on application for models listed
- May require a load equalizer



FITS MODEL	LED/LENS COLOR	PART #	SUG. RETAIL	FITS MODEL	LED/LENS COLOR	PART #	SUG. RETAIL	FITS MODEL	LED/LENS COLOR	PART #	SUG. RETAIL
VICTORY											
Vegas 03-16,	Red/red	2020-1242	\$289.95	Hammer 05-15,	Red/red	2020-1247	\$319.95	Jackpot,	Red/red	2020-1252	\$319.95
Vegas 8-Ball 06-16,	Red/clear	2020-1243	289.95	Hammer 8-Ball 10-15,	Red/clear	2020-1248	319.95	Ness Jackpot 06-15	Red/clear	2020-1253	319.95
High Ball 12-16,	Red/smoke	2020-1244	289.95	Hammer S 16	Red/smoke	2020-1249	319.95		Red/smoke	2020-1254	319.95
Gunner 15-16	Amber/clear	2020-1245	289.95		Amber/clear	2020-1250	319.95		Amber/clear	2020-1255	319.95
	Amber/smoke	2020-1246	289.95		Amber/smoke	2020-1251	319.95		Amber/smoke	2020-1256	319.95

THE CHEESE WEDGE FOR VICTORY VEGAS, KINGPIN, HAMMER, JACKPOT, VISION, CROSS COUNTRY

- Direct replacement for the factory "Cheese Wedge" emblem
- Add custom LED backlighting to create a visual highlight
- Emblem available in black or chrome
- Magic Flex2™ LED light kit sold separately; you must order a Cheese Wedge and the LED light kit for a complete assembly
- LED light kit includes LED lights and all necessary wiring and connectors for a quick, clean assembly

DESCRIPTION	PART #	SUG. RETAIL	DESCRIPTION	PART #	SUG. RETAIL	DESCRIPTION	PART #	SUG. RETAIL			
CHEESE WEDGE EMBLEM											
Chrome	0940-1490	\$69.95	CHEESE WEDGE LIGHT KITS (CONT)						\$19.95		
Black	0940-1491	69.95	Blue	2040-1868	19.95	CHEESE WEDGE LIGHT KITS (CONT)					
CHEESE WEDGE LIGHT KITS			Green	2040-1869	19.95	Pink	2040-1872	19.95			
Red	2040-1867	19.95	Orange	2040-1870	19.95	Amber	2040-1873	19.95			
			Purple	2040-1871	19.95	White	2040-1896	19.95			

CHEESE WEDGE BADGES

- Aluminum badge with 106 emblem
- Black with silver lettering
- Mounts with 3M double sided tape
- 3M ampule included
- Fits Victory Cheese Wedge

SUG. RETAIL \$29.95

DESCRIPTION	PART #	DESCRIPTION	PART #
Left	2040-1905	Right	2040-1906

TUBE CLAMPS FOR LED BILLET BULLETS

- Rubber inner sleeve protects tube finish
- Set screw for secure mounting (Allen wrench included)
- 5/16" mounting hole
- Sold in pairs

DESCRIPTION	CHROME	BLACK	DESCRIPTION	CHROME	BLACK
1 5/16"	2040-1907	2040-1908	1.75"	2040-1913	2040-1914
1.25"	2040-1909	2040-1910	2"	2040-1915	2040-1916
1.5"	2040-1911	2040-1912			

SUG. RETAIL \$44.95

All part numbers in **BOLD MAGENTA** are new this year.

VICTORY

EXHAUST

LUGGAGE

SECURITY

WINDSHIELDS

FAIRINGS & BODY

SEATS & Sissy BARS

HANDLEBARS & HAND CONTROLS

FOOTPEGS & FOOT CONTROLS

LIGHTING

ELECTRICAL

WHEELS & ACCESSORIES

BRAKES & SUSPENSION

ENGINE

FUEL/AIR SYSTEMS

INDIAN

EXHAUST

WINDSHIELDS

FAIRINGS & BODY

SEATS & Sissy BARS

HANDLEBARS & HAND CONTROLS

FOOTPEGS & FOOT CONTROLS

LIGHTING

ELECTRICAL

WHEELS & BRAKES

SUSPENSION

ENGINE

FUEL/AIR SYSTEMS



DRIVING LIGHT KITS FOR VICTORY CROSS COUNTRY, TOUR, MAGNUM MODELS 10-16

- Compact driving light mount kits
- Positioned in-line with the headlight for a true driving light experience, these mounts provide a clean look by attaching to the existing turn signal mounts
- Available with either 3 1/2" visored Halogen (55 watt) or LED lights, or as mounts only, to use with existing lights
- 3 1/2" light housings are Big Bike Parts market-leading steel housing with a built-in visor on the bezel creating that pure custom look
- Halogen or LED Spot lights come complete with wiring and custom switch for the Victory fairing

DESCRIPTION	PART #	SUG. RETAIL	DESCRIPTION	PART #	SUG. RETAIL
LED light kit	2040-1854	\$359.95	Mounts only for use w/ existing lights	2040-1855	\$69.95
Halogen light kit	2040-1853	179.95			

2001-1342



HIGHWAY BAR LED MINI DRIVING LIGHT KITS

- Available with 50W halogen or 7W/400 lumens/4000K LED lights
- Pair of die-cast 2 3/8" visored mini driving lights
- Includes pair of 1 1/4" highway bar clamps; additional clamps available separately
- Comes complete with wiring harness and isolation relay to protect your bike's circuit along with a choice of two styles of switches



DESCRIPTION	PART #	SUG. RETAIL	DESCRIPTION	PART #	SUG. RETAIL
Halogen kit	2001-1342	\$119.95	LED kit	2001-1343	\$149.95
			Pair of 1 1/4" clamps	1624-0318	\$22.95

MINI DRIVING LIGHTS

- Available in halogen or LED
- Die-cast body with smooth design comes in aluminum or black finish
- Visor integrated into bezel; setscrew allows visor to rotate to desired position for custom installation
- 3 3/4" L x 2 3/8" dia.; 8mm stem
- Halogen features 55W, 12V bulb
- LED features 7W, six 12V bulbs
- Sold each



DESCRIPTION	PART #	SUG. RETAIL	DESCRIPTION	PART #	SUG. RETAIL
HALOGEN			LED		
Aluminum	2040-0488	\$49.95	Aluminum	2001-1339	\$65.95
Black	2001-1340	49.95	Black	2001-1341	65.95

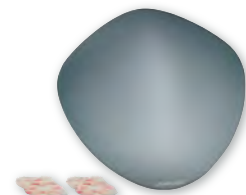

MINI LIGHT KITS FOR VICTORY CROSS COUNTRY, CROSS TOUR AND MAGNUM 10-16

- Designed for those that want a more compact driving light kit for the Victory Cross Country and Magnum models
- 2 3/8" Mini Driving Lights include Victory Cross Country light brackets
- Lights are die-cast and have a visor-shaped bezel
- Each light is 3 3/4" long and is offered in either a 50 watt halogen or 400 Lumen/4000K LED
- Non-dimmable LED kit works great with all non-RF-broadcasts such as Sirius/XM, Bluetooth, etc.

DESCRIPTION	PART #	SUG. RETAIL	DESCRIPTION	PART #	SUG. RETAIL
LED light kit	2001-1325	\$189.95	Halogen light kit	2001-1324	\$165.95

TRIANGULAR LAMPGARD™ HEADLIGHT PROTECTOR FOR VICTORY (ALL EXCEPT VISION)

- Protects expensive headlight from rocks and other road debris
- Triangular design to fit Victory headlights (except Vision)
- Uses 3M® dual lock fasteners for easy removing for cleaning
- Made in the U.S.A.

SUG. RETAIL	\$24.95
PART #	2001-1337

KURYAKYN

DRIVING LIGHTS

FOR CROSS COUNTRY/CROSS COUNTRY TOUR/MAGNUM 10-16

- 3" diameter driving lamps have DOT-compliant H3 bulbs for extremely bright light output
- Contoured bezels and streamlined housings match the appearance of the stock headlamp
- Mount brackets fit inside the fairing to support the additional weight of the lights
- Mount bracket relocates the OEM turn signals to a position similar to the stock mounting location
- Sold in pairs

NOTE: Require Kuryakyn wiring relay kit PART #2050-0131 for installation (sold separately).

COLOR	PART #
Chrome	2001-1360



2001-1360



2001-1361

SUG. RETAIL \$299.99

COLOR	PART #
Satin black	2001-1361



3501-1162

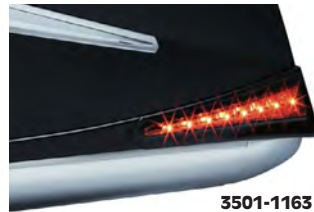

3501-1163

KURYAKYN

LED SADDLEBAG EXTENSIONS

FOR VICTORY CROSS COUNTRY/CROSS COUNTRY TOUR/MAGNUM 10-16, HARD BALL 12-13 AND CROSS ROADS 10-14 MODELS WITH SADDLEBAGS

- An affordable way to create a low, mean tail-dragger look
- Features red lenses and LED running lights
- Two-piece design installs with stock exhaust
- ABS plastic construction with a chrome or gloss black finish
- Easy plug-and-play installation requires no drilling

NOTE: Not compatible with OEM leather-covered bags.

SUG. RETAIL \$269.99

DESCRIPTION	PART #	DESCRIPTION	PART #
Chrome	3501-1162	Gloss black	3501-1163

KURYAKYN

SABERTOOTH LED SADDLEBAG ACCENTS

FOR VICTORY CROSS COUNTRY/CROSS COUNTRY TOUR/MAGNUM 10-16, CROSSROADS 10-14, HARDBALL 12-13

- Designed to complement the body lines of OEM saddlebags and coordinate with main taillight
- Function as additional run-brake rear lighting
- Peel-and-stick installation with plug-and-play wiring
- Sold in pairs

SUG. RETAIL \$149.99 PART # 2040-1539



2050-0216



BADLANDS VICTORY ILLUMINATOR MODULES

- Designed to add running light, brake light and turn signal functions to each rear turn signal
- Features a built-in load equalizer that is perfect for switching out factory turn signals to halogen or LED versions
- Plug-n-play design for easy installation
- Made in the U.S.A.

SUG. RETAIL \$118.95

FITS MODEL	PART #
VICTORY	
Jackpot, Hammer, Vegas, Kingpin, Highball and Gunner 09-15 models (all)	2050-0216
Cross Country, Cross Roads and Magnum 11-15 models (all)	2050-0217
All non-touring models w/ LEDs 09-15	2050-0268

All part numbers in **BOLD MAGENTA** are new this year.



2020-1205

2020-1206

REAR RED LED TURN SIGNALS

FOR VICTORY CROSS COUNTRY

- Black or chrome housing
- Plug-n-play
- For use with Badlands Illuminator module PART #2050-0217; sold separately below
- Sold in pairs

SUG. RETAIL \$105.95

DESCRIPTION	PART #	DESCRIPTION	PART #
Black	2020-1205	Chrome	2020-1206



LOAD EQUALIZER

- For use on Victory 05-17 motorcycles with Custom Dynamics or MBW LED turn signals
- Use one load equalizer on 11-17 bikes when either one or both sets of LEDs are installed
- Use one load equalizer on 05-10 bikes when both front and rear LEDs are installed
- Posi-Taps Included



SUG. RETAIL \$29.95 PART # 2050-0252

VICTORY

EXHAUST

LUGGAGE

SECURITY

WINDSHIELDS

FAIRINGS & BODY

SEATS & Sissy BARS

HANDLEBARS & HAND CONTROLS

FOOTPEGS & FOOT CONTROLS

LIGHTING

ELECTRICAL

WHEELS & ACCESSORIES

BRAKES & SUSPENSION

ENGINE

FUEL/AIR SYSTEMS

INDIAN

EXHAUST

WINDSHIELDS

FAIRINGS & BODY

SEATS & Sissy BARS

HANDLEBARS & HAND CONTROLS

FOOTPEGS & FOOT CONTROLS

LIGHTING

ELECTRICAL

WHEELS & BRAKES

SUSPENSION

ENGINE

FUEL/AIR SYSTEMS



EVO3 LIGHTWEIGHT LITHIUM-ION BATTERIES

- EVO3 is the latest evolution of lightweight Lithium-Ion batteries built to fit the OEM battery compartment, but with multiple power options
- The lightest, most powerful starter battery available, no matter what you ride
- State-of-the-art Lithium Ferrous Phosphate (LiFePO4) technology
- Extremely durable with an exceptional static self-charge rate of only 10% per year
- Up to 10 lb. lighter than the stock battery
- "Dry" technology that can be mounted in any direction
- Extensively tested by professional race teams
- Environmentally friendly, non-toxic and recyclable
- Designed, developed and assembled in the U.S.A.

NOTE: Operating environment: 0°F (-18°C) to 140°F (60°C)

NOTE: For applications used in cold environments or with high-performance modifications, we recommend using the EVO3 Upgrade. The EVO3 Upgrade is dimensionally the same, but has higher burst cranking amps.

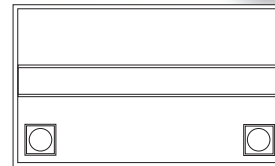

PART #	DESCRIPTION	BURST CRANKING AMPS		AMP HOURS	DIMENSIONS	WEIGHT (LB.)	LEFT POST	RIGHT POST	SUG. RETAIL
		(5 SEC. AT 70°F)							
2113-0354	EVO3 EVX20L-16	480		9.2	6.9" L X 3.4" W X 6.1" H	3.8	-	+	\$299.95
2113-0355	EVO3 EVX20L-24	720		13.8	6.9" L X 3.4" W X 6.1" H	4.8	-	+	419.95

FITS MODEL	EVO3	EVO3 UPGRADE	FITS MODEL	EVO3	EVO3 UPGRADE
VICTORY			VICTORY (CONT)		
V92SC Sport Cruiser 00-01	2113-0354	2113-0355	1507 Vegas, Kingpin, Hammer 03-05	2113-0354	2113-0355
V92C, DC Classic, Deluxe Cruiser 98-04	2113-0354	2113-0355	1634 Vegas, Kingpin, Hammer 06-10	2113-0354	2113-0355
V92TC, Touring Cruiser 02-06	2113-0354	2113-0355	1734 Vegas, Jackpot, Hammer, Ness, Vision 08-13	2113-0354	2113-0355



POWER MAX MAINTENANCE-FREE BATTERIES

- Completely sealed black case can be mounted in almost any position
- Advanced technology allows very high power discharge
- Accept a high rate of recharge without damage to the battery
- Can be recharged over 90% in less than one hour on a regulated charger
- Battery **MUST BE CHARGED** in the same manner as any lead acid battery
- When not in service, battery should be charged once a month

SUG. RETAIL **\$111.95**

YUASA REFERENCE #	PART #	YUASA REFERENCE #	PART #
YTX20-BS	DS-325030	YTX20L-BS	DS-325024

DISCLAIMER: NOT LEGAL FOR SALE OR USE IN CALIFORNIA ON ANY POLLUTION CONTROLLED MOTOR VEHICLES.

SEE PAGE 3 FOR IMPORTANT EMISSION DEFINITIONS AND REGULATORY COMPLIANCE AND WARRANTY INFORMATION.



YUASA BATTERY

BATTERIES

- Yuasa is the world's largest manufacturer of motorcycle batteries and has over 50 years of expertise behind its product

HIGH-PERFORMANCE AGM MAINTENANCE-FREE BATTERY

- This new generation of maintenance-free batteries delivers higher cranking amps for vehicles that require extra starting power
- Additional cranking amps make these one of the most powerful batteries on the market
- Acid pack included, except where noted as Factory-activated

NOTE: Factory-activated batteries should be charged once a month when not in service.

AGM (MAINTENANCE-FREE) BATTERY

- Special absorbed-glass mat battery eliminates water loss, permitting the battery to be permanently sealed once it is filled with acid; Acid Pak included
- Truly the world's finest "install it and forget it" motorcycle battery

PART #	SUG. RETAIL	PART #	SUG. RETAIL
HIGH-PERFORMANCE AGM MAINTENANCE-FREE BATTERIES		AGM (MAINTENANCE-FREE) BATTERIES	
2113-0104 ¹	\$129.95	YTX20L-BS	\$119.95
YTX20HL-BS	127.95		

¹ Factory-Activated; Yuasa reference #YTX20HL.

VICTORY

EXHAUST

LUGGAGE

SECURITY

WINDSHIELDS

FAIRINGS & BODY

SEATS & Sissy BARS

HANDLEBARS & HAND CONTROLS

FOOTPEGS & FOOT CONTROLS

LIGHTING

ELECTRICAL

WHEELS & ACCESSORIES

BRAKES & SUSPENSION

ENGINE

FUEL/AIR SYSTEMS

INDIAN

EXHAUST

WINDSHIELDS

FAIRINGS & BODY

SEATS & Sissy BARS

HANDLEBARS & HAND CONTROLS

FOOTPEGS & FOOT CONTROLS

LIGHTING

ELECTRICAL

WHEELS & BRAKES

SUSPENSION

ENGINE

FUEL/AIR SYSTEMS



HIGH PERFORMANCE BATTERIES

- Specifically designed for high-performance engines that need extra cranking power
- Superior engineering features include an AGM (Absorbed glass-matt) radial grid design for maximum cranking amps
- High vibration resistance
- Spill-proof, pre-filled, pre-charged, maintenance-free sealed design
- Batteries include brass spacers, stainless steel nuts, bolts and star washers
- Made in the U.S.A.

NOTE: Factory-activated batteries should be charged once a month when not in service.

SUG. RETAIL **\$116.95**



YUASA REFERENCE #
YTX20HL

PART #
2113-0012



AGM MAINTENANCE-FREE BATTERIES

- Parts Unlimited is proud to offer a premium-quality maintenance-free battery and a great low price
- Special absorbed-glass mat battery eliminates water loss, permitting the battery to be permanently sealed once it is filled with acid
- Acid pak included
- Truly the world's finest "install it and forget it" motorcycle battery
- Battery seals to prevent water loss
- Holds charge three times longer than conventional batteries

SUG. RETAIL **\$78.95**



YUASA REFERENCE #
YTX20HL-BS

PART #
2113-0022

PARTS UNLIMITED YUASA BATTERY
BATTERY APPLICATIONS CHART

FITS MODEL	YUASA HIGH-PERFORMANCE AGM MAINTENANCE-FREE	YUASA AGM MAINTENANCE-FREE	PARTS UNLIMITED AGM MAINTENANCE-FREE	DRAG SPECIALTIES HIGH PERFORMANCE BATTERIES
VICTORY				
All 106CI models 08-14	YTX20HL-BS ¹	YTX20L-BS	2113-0022	2113-0012
Hammer, Kingpin, Vegas 03-08	YTX20HL-BS ¹	YTX20L-BS	2113-0022	2113-0012
V92C/SC/TC 98-06 (all)	YTX20HL-BS ¹	YTX20L-BS	2113-0022	2113-0012

¹ Factory-Activated, High-Performance AGM Maintenance-Free battery also available, PART #2113-0104.

DISCLAIMER: NOT LEGAL FOR SALE OR USE IN CALIFORNIA ON ANY POLLUTION CONTROLLED MOTOR VEHICLES. SEE PAGE 3 FOR IMPORTANT EMISSION DEFINITIONS AND REGULATORY COMPLIANCE AND WARRANTY INFORMATION.

All part numbers in **BOLD MAGENTA** are new this year.

VICTORY

EXHAUST

LUGGAGE

SECURITY

WINDSHIELDS

FAIRINGS & BODY

SEATS & Sissy BARS

HANDLEBARS & HAND CONTROLS

FOOTPEGS & FOOT CONTROLS

LIGHTING

ELECTRICAL

WHEELS & ACCESSORIES

BRAKES & SUSPENSION

ENGINE

FUEL/AIR SYSTEMS

INDIAN

EXHAUST

WINDSHIELDS

FAIRINGS & BODY

SEATS & Sissy BARS

HANDLEBARS & HAND CONTROLS

FOOTPEGS & FOOT CONTROLS

LIGHTING

ELECTRICAL

WHEELS & BRAKES

SUSPENSION

ENGINE

FUEL/AIR SYSTEMS



2112-1150

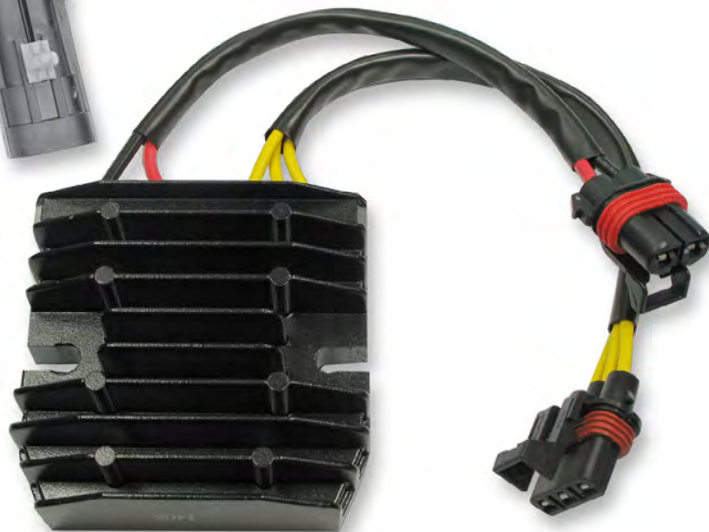

2112-1016



RECTIFIER/REGULATORS

- OEM-style rectifier/regulators (unless noted)
- Direct plug-in stators complete with all rubbers and OEM-style plug end
- High-performance, heavy-duty Hot Shot series version (as noted) is made with a special Mosfet technology for cooler running

SUG. RETAIL \$149.95

FITS MODEL	PART #
VICTORY	
Boardwalk 13-15	2112-1150
Cross Country 8-Ball 11, 14-16	2112-1149
Cross Country Ness 11-14	2112-1149
Cross Country Touring 12-16	2112-1149
Cross Country Touring Ness 13-14	2112-1149
Cross Roads 10	2112-1149
Cross Roads 8-Ball 14	2112-1149
Cross Roads Classic 13-14	2112-1149
Cross Roads Classic LE 12	2112-1149
Cross Roads Custom 11	2112-1149
Gunner 15-16	2112-1150
Hammer 05-07, Hammer Sport 07	2112-0935
Hammer 08-11	2112-1150
Hammer 8-Ball 10-15	2112-1150
Hammer LE 14	2112-1150
Hammer Sport (S) 08-15	2112-1150
Hard-Ball 12-13	2112-1149
Highball 12-16	2112-1150
Jackpot 08-15	2112-1150
Jackpot Ness 08-10	2112-1150
Judge 13-15	2112-1150
Kingpin 04-05	2112-1016
Kingpin 10-12	2112-1150
Kingpin 8-Ball 08-11	2112-1150
Kingpin/Kingpin Deluxe 06-07	2112-0935

FITS MODEL	PART #
VICTORY (CONT)	
Magnum 15-16	2112-1149
V92 Classic Cruiser/Touring Cruiser 03-06	2112-1016
V92 Deluxe Touring Cruiser 02	2112-1148
V92 Deluxe Cruiser 02	2112-1148
V92 Standard Cruiser 02	2112-1148
V92 Touring Cruiser 02	2112-1148
V92C/Dix/Sport Cruiser 99-01	2112-0868 ¹
Vegas 03-04	2112-1016
Vegas 06-07, Vegas 8-ball 07	2112-0935
Vegas 08-12, 16	2112-1150
Vegas 8-Ball 05	2112-1016
Vegas 8-Ball 08-16	2112-1150
Vegas Jackpot/Vegas Jackpot Ness 06-07	2112-0935
Vegas Low 08-10	2112-1150
Vegas Ness 04	2112-1016
Vegas Ness 11-12	2112-1150
Vision 08 09, 15-16	2112-1149
Vision 8-Ball 10-11	2112-1149
Vision Ness 09-12	2112-1149
Vision Street 09	2112-1149
Vision Tour 08-14	2112-1149
Vision Tour Ness 13	2112-1149
Vision Tour Premium 10-11	2112-1149

¹ Hot Shot series.



PLUG WIRES FOR VICTORY 08-15 (ALL)

- Constructed with silicone throughout the jacket, insulation and core to deliver high-temperature resistance
- Rated at SAE Class E J2031 with a continuous operating temperature of 450° F
- Made in the U.S.A.

SUG. RETAIL \$35.95 PART #

2104-0295



DISCLAIMER: NOT LEGAL FOR SALE OR USE IN CALIFORNIA ON ANY POLLUTION CONTROLLED MOTOR VEHICLES. SEE PAGE 3 FOR IMPORTANT EMISSION DEFINITIONS AND REGULATORY COMPLIANCE AND WARRANTY INFORMATION.

VICTORY

EXHAUST

LUGGAGE

SECURITY

WINDSHIELDS

FAIRINGS & BODY

SEATS & Sissy BARS

HANDLEBARS & HAND CONTROLS

FOOTPEGS & FOOT CONTROLS

LIGHTING

ELECTRICAL

WHEELS & ACCESSORIES

BRAKES & SUSPENSION

ENGINE

FUEL/AIR SYSTEMS

INDIAN

EXHAUST

WINDSHIELDS

FAIRINGS & BODY

SEATS & Sissy BARS

HANDLEBARS & HAND CONTROLS

FOOTPEGS & FOOT CONTROLS

LIGHTING

ELECTRICAL

WHEELS & BRAKES

SUSPENSION

ENGINE

FUEL/AIR SYSTEMS



2110-0720



2110-0721

PARTS UNLIMITED STARTERS

- Starters manufactured to meet or exceed OEM specifications
- Insulated armature for rust and corrosion protection
- Rubber seals on top and bottom side of unit - ensures dry operation for longer life
- 90/10 copper bushings - longer life
- One-year warranty

SUG. RETAIL **\$189.95**

FITS MODEL	BLACK	SILVER
VICTORY		
Arlen Ness Signature Jackpot 06-08	2110-0720	2110-0721
Arlen Ness Signature Kingpin 05	2110-0720	2110-0721
Arlen Ness Signature Vegas 05	2110-0720	2110-0721
Arlen Ness Signature Vision 09-10	2110-0720	2110-0721
Arlen Ness Signature Vision 11-13	2110-0720	-
Boardwalk 13-15	2110-0720	-
Classic Cruiser 03	2110-0720	2110-0721
Cory Ness Signature Jackpot 08-10	2110-0720	2110-0721
Cross Country 10-15	2110-0720	-
Cross Country 8-Ball 14-15	2110-0720	-
Cross Country Tour 14-15	2110-0720	-
Cross Country Roads 10-13	2110-0720	-
Cross Roads 8-Ball 14	2110-0720	-
Cross Roads Classic 14	2110-0720	-
Deluxe Cruiser 01-02	2110-0720	-
Deluxe Touring Cruiser 02	2110-0720	-
Gunner 14-15	2110-0720	-
Hammer 05-10	2110-0720	2110-0721
Hammer 11	2110-0720	-
Hammer S 07-10	2110-0720	2110-0721
Hammer S 11-13	2110-0720	-
Hammer 8-Ball 10-15	2110-0720	-
High-Ball 12-15	2110-0720	-
Jackpot 06-10	2110-0720	2110-0721
Jackpot 14	2110-0720	-
Judge 13-14	2110-0720	-
Kingpin 04-10	2110-0720	2110-0721
Kingpin 11-12	2110-0720	-
Kingpin 8-Ball 08-10	2110-0720	2110-0721
Kingpin 8-Ball 11	2110-0720	-

FITS MODEL	BLACK	SILVER
VICTORY (CONT)		
Kingpin Low 09	2110-0720	2110-0721
Kingpin Tour 04-09	2110-0720	2110-0721
Magnum/X-1 15	2110-0720	-
Ness Cross Country 14	2110-0720	-
Ness Magnum 15	2110-0720	-
V92C Special Edition 00	2110-0720	-
V92C Sport Cruiser 00-02	2110-0720	-
V92C Sport Cruiser 03	2110-0720	2110-0721
V92C Standard Cruiser 99-02	2110-0720	-
V92C Touring Cruiser 02	2110-0720	-
V92C Touring Cruiser 03	2110-0720	2110-0721
Touring Cruiser 04-06	2110-0720	2110-0721
Vegas 03-10	2110-0720	2110-0721
Vegas 11-13	2110-0720	-
Vegas 8-Ball 05-10	2110-0720	2110-0721
Vegas 8-Ball 11-15	2110-0720	-
Vegas Jackpot 06-09	2110-0720	2110-0721
Vegas Jackpot 11-13	2110-0720	-
Vegas Low 08-09	2110-0720	2110-0721
Vegas ZNSS 11-12	2110-0720	-
Vision 8-Ball 10	2110-0720	2110-0721
Vision 8-Ball 11	2110-0720	-
Vision Street 08-09	2110-0720	2110-0721
Vision Street Premium 08-09	2110-0720	2110-0721
Vision Tour 08-10	2110-0720	2110-0721
Vision Tour 11-15	2110-0720	-
Vision Tour 10th Anniversary 09	2110-0720	2110-0721
Vision Tour Comfort 08-10	2110-0720	2110-0721
Vision Tour Premium 08-10	2110-0720	2110-0721

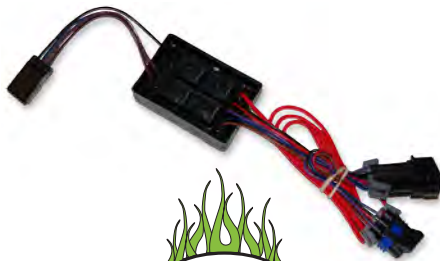

TRAILER ISOLATOR MODULE WITH 5 TO 4 WIRE CONVERTER

FOR VICTORY JUDGE, BOARDWALK, CROSS COUNTRY, MAGNUM 11-15

- Prevents overloading of factory lighting circuit
- For use with 4-wire trailers

SUG. RETAIL **\$119.95**

PART # **2050-0261**



2120-0866



24" HANDLEBAR EXTENSION HARNESSES

- All the items needed to successfully extend the wiring to a set of OEM handlebar switches
- Made in the U.S.A.

FITS MODEL	PART #	SUG. RETAIL
VICTORY		
All models 09-16 (except Touring models)	2120-0865	\$59.95
All Touring models 09-16 (w/ audio and cruise control)	2120-0866	74.95



ROCKER SWITCH

- Switch has 8A @ 12V load on one side and 10A @ 30V load on other
- Measures approximately 0.480" x 1.072"
- Available in black

SUG. RETAIL **\$2.95**

PART # **2106-0385**

DISCLAIMER: NOT LEGAL FOR SALE OR USE IN CALIFORNIA ON ANY POLLUTION CONTROLLED MOTOR VEHICLES. SEE PAGE 3 FOR IMPORTANT EMISSION DEFINITIONS AND REGULATORY COMPLIANCE AND WARRANTY INFORMATION.

All part numbers in **BOLD MAGENTA** are new this year.

VICTORY

EXHAUST

LUGGAGE

SECURITY

WINDSHIELDS

FAIRINGS & BODY

SEATS & SISSY BARS

HANDLEBARS & HAND CONTROLS

FOOTPEGS & FOOT CONTROLS

LIGHTING

ELECTRICAL

WHEELS & ACCESSORIES

BRAKES & SUSPENSION

ENGINE

FUEL/AIR SYSTEMS

INDIAN

EXHAUST

WINDSHIELDS

FAIRINGS & BODY

SEATS & SISSY BARS

HANDLEBARS & HAND CONTROLS

FOOTPEGS & FOOT CONTROLS

LIGHTING

ELECTRICAL

WHEELS & BRAKES

SUSPENSION

ENGINE

FUEL/AIR SYSTEMS

Savage Eclipse



Savage Chrome



Majestic Eclipse



Majestic Chrome



FORGED WHEELS

- Made from the highest-quality forged aluminum available to create a strong and durable wheel
- CNC machined and tested to ensure proper fitment and quality
- Available in chrome or an Eclipse Black finish
- Matching belt pulleys and brake rotors available when applicable; see page 65 & page 71
- RC pulley bolts required for some applications; see page 65
- Made in the U.S.A.

NOTE: Non-ABS front wheel applications require the purchase of RC 11.8" (5-hole) front brake rotors.

NOTE: ABS front wheel applications use OEM (6-hole) front brake rotors.

NOTE: 21" and 23" front wheel applications can not use factory front fender.

FRONT WHEELS

SIZE	SAVAGE ECLIPSE	SAVAGE CHROME	MAJESTIC ECLIPSE	MAJESTIC CHROME	SUG. RETAIL
VICTORY CROSS ROADS/CROSS COUNTRY 10-14 (NON-ABS)					
18 x 3.50	0201-1955 ¹	0201-1963 ¹	0201-1971 ¹	0201-1979 ¹	\$1,249.95
19 x 3.00	0201-1956 ¹	0201-1964 ¹	0201-1972 ¹	0201-1980 ¹	1,249.95
21 x 3.50	0201-1957 ^{1,2}	0201-1965 ^{1,2}	0201-1973 ^{1,2}	0201-1981 ^{1,2}	1,299.95
23 x 3.75	0201-1958 ^{1,3}	0201-1966 ^{1,3}	0201-1974 ^{1,3}	0201-1982 ^{1,3}	1,645.95
VICTORY CROSS ROADS/CROSS COUNTRY 10-14 (ABS)					
18 x 3.50	0201-1959 ⁴	0201-1967 ⁴	0201-1975 ⁴	0201-1983 ⁴	1,249.95
19 x 3.00	0201-1960 ⁴	0201-1968 ⁴	0201-1976 ⁴	0201-1984 ⁴	1,249.95
21 x 3.50	0201-1961 ^{2,4}	0201-1969 ^{2,4}	0201-1977 ^{2,4}	0201-1985 ^{2,4}	1,299.95
23 x 3.75	0201-1962 ^{3,4}	0201-1970 ^{3,4}	0201-1978 ^{3,4}	0201-1986 ^{3,4}	1,645.95

¹ Requires purchase of RC Components 11.8" front rotors (5 hole).

² Requires custom 21" front fender.

³ Requires custom 23" front fender.

⁴ Uses factory OEM brake rotors (6 hole).

REAR WHEELS

SIZE	SAVAGE ECLIPSE	SAVAGE CHROME	MAJESTIC ECLIPSE	MAJESTIC CHROME	SUG. RETAIL
VICTORY CROSS ROADS/CROSS COUNTRY 10-14 (NON-ABS)					
(FOR USE W/ RC MATCHING REAR ROTOR AND PULLEY)					
16 x 5.50	0202-1965 ¹	0202-1969 ¹	0202-1973 ¹	0202-1977 ¹	\$1,249.95
17 x 6.25	0202-1966 ¹	0202-1970 ¹	0202-1974 ¹	0202-1978 ¹	1,299.95
VICTORY CROSS ROADS/CROSS COUNTRY 10-14 (ABS/NON-ABS)					
16 x 5.50	0202-1967 ²	0202-1971 ²	0202-1975 ²	0202-1979 ²	1,249.95
17 x 6.25	0202-1968 ²	0202-1972 ²	0202-1976 ²	0202-1980 ²	1,299.95

¹ Requires purchase of RC Components rear brake rotor and drive pulley (5 hole).

² Uses factory OEM rear brake rotor and drive pulley.

SAFETY WARNING: WHEN SELECTING CUSTOM WHEELS, THE TIRES USED FOR YOUR APPLICATION MUST HAVE A LOAD INDEX AND SPEED RATING EQUAL TO OR GREATER THAN THE TIRES FITTED AS ORIGINAL EQUIPMENT. CONSULT MANUFACTURER'S PUBLICATION(S) AND/OR WEBSITE(S) FOR COMPLETE TIRE INFORMATION.

Savage Eclipse



Savage Chrome



Majestic Eclipse



Majestic Chrome



PULLEYS

- Billet aluminum pulleys are CNC-machined and quality tested
- Savage and Majestic designs are available in chrome or an Eclipse Black finish
- Pulley bolts are required to mount
- Made in the U.S.A.

NOTE: For RC Components wheels only.

DESCRIPTION	PART #	SUG. RETAIL	DESCRIPTION	PART #	SUG. RETAIL
VICTORY CROSSROADS/CROSS COUNTRY 10-14 (NON-ABS)					
Savage Eclipse	1201-0794	\$549.95	Majestic Eclipse	1201-0796	\$549.95
Savage Chrome	1201-0795	549.95	Majestic Chrome	1201-0797	549.95



PULLEY BOLTS

DESCRIPTION	PART #	SUG. RETAIL
7/16"-14 X 1 1/4"	2401-0312	\$15.95

WHEEL BEARING AND SEAL KITS

- Exact OEM replacement bearing and seal kits bring back the steering and braking control lost due to worn or rusted wheel bearings
- Each kit includes necessary bearings and seals to completely rebuild each hub
- Double-sealed ball bearings keep moisture and contamination from entering bearing
- Seals ensure proper fitment
- Kits are available separately for front and rear wheels



0215-0818



FITS MODEL	FRONT	SUG. RETAIL	REAR	SUG. RETAIL	FITS MODEL	FRONT	SUG. RETAIL	REAR	SUG. RETAIL					
VICTORY														
Cruiser 99-06	0215-0815	\$19.95	-	-	VICTORY (CONT)									
8 Ball 05-11	-	-	0215-0818	\$24.95	Hardball 12-14	-	-	0215-0818	\$24.95					
Arlen Ness 04-11	-	-	0215-0818	24.95	Highball 12-15	-	-	0215-0818	24.95					
Boardwalk 14-15	-	-	0215-0818	24.95	Jackpot 06-08, 13-15	-	-	0215-0818	24.95					
Cross Country 10-15	-	-	0215-0818	24.95	Judge 13-15	-	-	0215-0818	24.95					
Cross Roads 10-14	-	-	0215-0818	24.95	King Pin 05-11	-	-	0215-0818	24.95					
Gunner 15	-	-	0215-0818	24.95	Magnum 15	-	-	0215-0818	24.95					
Hammer 05-15	-	-	0215-0818	24.95	Vegas 03-15	-	-	0215-0818	24.95					
					Vision 08-15	-	-	0215-0818	24.95					



WHEEL BEARING AND SEAL KITS

- High-speed bearings are manufactured to ABEC 3 precision levels
- Triple-lip rubber seals keep the grease in and the water and dirt out
- Chevron SRI 2 grease contains rust and oxidation inhibitors (-20°-350°F)
- Double-lip type TC seals with stainless steel garter springs



FITS MODEL	POSITION	PART #	SUG. RETAIL	FITS MODEL	POSITION	PART #	SUG. RETAIL	FITS MODEL	POSITION	PART #	SUG. RETAIL				
VICTORY															
Boardwalk 13	Front	0215-0092	\$23.40	VICTORY (CONT)											
	Rear	0215-0092	23.40	Highball 12-13	Front	0215-0092	\$23.40	Standard Cruiser 99-02	Front	0215-0056	\$16.49				
Classic Cruiser 03	Front	0215-0056	16.49		Rear	0215-0092	23.40		Rear	0215-0056	16.49				
	Rear	0215-0056	16.49	Jackpot 06-13	Front	0215-0092	23.40	Touring Cruiser 02-06	Front	0215-0056	16.49				
Cross Country/ _Cross Roads 10-13	Front	0215-0092	23.40		Rear	0215-0092	23.40		Rear	0215-0056	16.49				
	Rear	0215-0092	23.40	Judge 13	Front	0215-0092	23.40	Vegas 03-05	Front	0215-0092	23.40				
Deluxe Cruiser 01	Front	0215-0056	16.49		Rear	0215-0092	23.40		Rear	0215-0092	23.40				
	Rear	0215-0056	16.49	Kingpin 04-12	Front	0215-0092	23.40	Vegas 8 Ball 06-13	Front	0215-0092	23.40				
Deluxe Touring Cruiser, _Deluxe Cruiser 02	Front	0215-0056	16.49		Rear	0215-0092	23.40		Rear	0215-0092	23.40				
	Rear	0215-0056	16.49	Special Edition 00	Front	0215-0056	16.49	Vision 08-13	Front	0215-0092	23.40				
Hammer 05-13	Front	0215-0092	23.40		Rear	0215-0056	16.49		Rear	0215-0092	23.40				
	Rear	0215-0092	23.40	Sport Cruiser 00-01	Front	0215-0056	16.49								
					Rear	0215-0056	16.49								

SAFETY WARNING: WHEN SELECTING CUSTOM WHEELS, THE TIRES USED FOR YOUR APPLICATION MUST HAVE A LOAD INDEX AND SPEED RATING EQUAL TO OR GREATER THAN THE TIRES FITTED AS ORIGINAL EQUIPMENT. CONSULT MANUFACTURER'S PUBLICATION(S) AND/OR WEBSITE(S) FOR COMPLETE TIRE INFORMATION.

All part numbers in **BOLD MAGENTA** are new this year.

partsnetweb.com / dragnetweb.com

VICTORY

EXHAUST

LUGGAGE

SECURITY

WINDSHIELDS

FAIRINGS & BODY

SEATS & SISSY BARS

HANDLEBARS & HAND CONTROLS

FOOTPEGS & FOOT CONTROLS

LIGHTING

ELECTRICAL

WHEELS & ACCESSORIES

BRAKES & SUSPENSION

ENGINE

FUEL/AIR SYSTEMS

INDIAN

EXHAUST

WINDSHIELDS

FAIRINGS & BODY

SEATS & SISSY BARS

HANDLEBARS & HAND CONTROLS

FOOTPEGS & FOOT CONTROLS

LIGHTING

ELECTRICAL

WHEELS & BRAKES

SUSPENSION

ENGINE

FUEL/AIR SYSTEMS

VICTORY BRAKE PAD APPLICATION CHART

- A complete brake pad application guide
- For optional brake pad compounds available, see pages 66-70

VICTORY BRAKE PAD APPLICATION CHART

FITS MODEL	DRAG SPECIALTIES FRONT PAD PART #	DRAG SPECIALTIES REAR PAD PART #	DP BRAKES FRONT PAD PART #	DP BRAKES REAR PAD PART #	EBC FRONT PAD PART #	EBC REAR PAD PART #	SBS FRONT PAD PART #	SBS REAR PAD PART #	BRAKING FRONT PAD PART #	BRAKING REAR PAD PART #
VICTORY										
V925C Victory 00-03	1721-1950	1721-1949	SDP-630HH	DP623	FA244HH	FA209/2HH	1721-1483	1721-1485	784CM55	780SM15
8-Ball 05-07	-	-	SDP-630HH	DP623	FA244HH	FA209/2HH	1722-0673	1721-1485	784CM55	780SM15
8-Ball 08	-	-	SDP-922HH	DP-118	FA347HH	FA196HH	1722-0674	1722-0672	-	1721-0098
Arlen Ness 04-07	-	-	SDP-630HH	DP623	FA244HH	FA209/2HH	1722-0673	1721-1485	784CM55	780SM15
Arlen Ness 08-09	-	-	SDP-922HH	DP-118	FA347HH	FA196HH	1722-0674	1722-0672	-	1721-0098
Arlen Ness Victory Vision 10-12	1721-1951	1721-1948	SDP-124HH	DP-118	FA261HH	FA196HH	1722-0671	1722-0672	-	1721-0098
Boardwalk 13-14	1721-1952	1721-1948	SDP-922HH	DP-118	FA347HH	FA196HH	1722-0674	1722-0672	-	1721-0098
Cross Country 10-16 (all)	1721-1952	1721-1948	SDP-922HH	DP-118	FA347HH	FA196HH	1722-0674	1722-0672	-	1721-0098
Cross Country Tour 12	1721-1952	1721-1948	SDP-922HH	DP-118	FA347HH	FA196HH	1722-0674	1722-0672	-	1721-0098
Crossroads 8-Ball/Classic 10-14	1721-1952	1721-1948	SDP-922HH	DP-118	FA347HH	FA196HH	1722-0674	1722-0672	-	1721-0098
Cross Touring 13-14	1721-1952	1721-1948	SDP-922HH	DP-118	FA347HH	FA196HH	1722-0674	1722-0672	-	1721-0098
Cory Ness Jackpot 08-10	1721-1952	1721-1948	SDP-922HH	DP-118	FA347HH	FA196HH	1722-0674	1722-0672	-	1721-0098
Ness Signature Series 05-07	1721-1950	1721-1949	SDP-630HH	DP623	FA244HH	FA209/2HH	1722-0673	1721-1485	784CM55	780SM15
Gunner 15-16	1721-1952	1721-1948	SDP-922HH	DP-118	FA347HH	FA196HH	1722-0674	1722-0672	-	-
Hammer 05-07	1721-1950	1721-1949	SDP-630HH	DP623	FA244HH	FA209/2HH	1722-0673	1721-1485	784CM55	780SM15
Hammer 08-10	1721-1950	1721-1948	SDP-922HH	DP-118	FA347HH	FA196HH	1722-0674	1722-0672	-	1721-0098
Hammer S 07	1721-1950	1721-1949	SDP-630HH	DP623	FA244HH	FA209/2HH	1722-0673	1721-1485	784CM55	780SM15
Hammer S 08-16	1721-1952	1721-1948	SDP-922HH	DP-118	FA347HH	FA196HH	1722-0674	1722-0672	-	1721-0098
Hammer 8-Ball 10-16	1721-1952	1721-1948	SDP-922HH	DP-118	FA347HH	FA196HH	1722-0674	1722-0672	-	1721-0098
Hard Ball 12-14	1721-1952	1721-1948	SDP-922HH	DP-118	FA347HH	FA196HH	1722-0674	1722-0672	-	1721-0098
High Ball 14-16 (cast or spoke wheel)	1721-1952	1721-1948	SDP-922HH	DP-118	FA347HH	FA196HH	1722-0674	1722-0672	-	-
Jackpot 06-07	1721-1950	1721-1949	SDP-630HH	DP623	FA244HH	FA209/2HH	1722-0673	1721-1485	784CM55	780SM15
Jackpot 08-14	1721-1952	1721-1948	SDP-922HH	DP-118	FA347HH	FA196HH	1722-0674	1722-0672	-	1721-0098
Judge 13-16	1721-1952	1721-1948	SDP-922HH	DP623	FA347HH	FA196HH	1722-0674	1722-0672	-	780SM15
Kingpin 04-07	1721-1950	1721-1949	SDP-630HH	DP623	FA244HH	FA209/2HH	1722-0673	1721-1485	784CM55	780SM15
Kingpin 08-12	1721-1952	1721-1948	SDP-922HH	DP-118	FA347HH	FA196HH	1722-0674	1722-0672	-	1721-0098
Kingpin Tour 07	1721-1950	1721-1949	SDP-630HH	DP623	FA244HH	FA209/2HH	1722-0673	1721-1485	784CM55	780SM15
Kingpin Tour 08-09	1721-1948	1721-1948	SDP-922HH	DP-118	FA347HH	FA196HH	1722-0674	1722-0672	-	1721-0098
Kingpin 8-Ball 08-11	1721-1952	1721-1948	SDP-922HH	DP-118	FA347HH	FA196HH	1722-0674	1722-0672	-	780SM15
Kingpin Low 09	1721-1952	1721-1948	SDP-922HH	DP-118	FA347HH	FA196HH	1722-0674	1722-0672	-	780SM15
Magnum/Magnum X-1 15-16	1721-1952	1721-1948	SDP-922HH	DP-118	FA347HH	FA196HH	1722-0674	1722-0672	-	780SM15
Vegas 03-07	1721-1950	1721-1949	SDP-630HH	DP623	FA244HH	FA209/2HH	1722-0673	1721-1485	784CM55	780SM15
Vegas 08-16	1721-1952	1721-1948	SDP-922HH	DP-118	FA347HH	FA196HH	1722-0674	1722-0672	-	1721-0098
Vegas 8-Ball 05-07	1721-1950	1721-1949	SDP-630HH	DP623	FA244HH	FA209/2HH	1722-0673	1721-1485	784CM55	780SM15
Vegas 8-Ball 08-16	1721-1952	1721-1948	SDP-922HH	DP-118	FA347HH	FA196HH	1722-0674	1722-0672	-	1721-0098
Vegas Jackpot 06-07	1721-1950	1721-1949	SDP-630HH	DP623	FA244HH	FA209/2HH	1722-0673	1721-1485	784CM55	780SM15
Vegas Jackpot 08-12	1721-1952	1721-1948	SDP-922HH	DP-118	FA347HH	FA196HH	1722-0674	1722-0672	-	1721-0098
Vegas Low 08-09	1721-1952	1721-1948	SDP-922HH	DP-118	FA347HH	FA196HH	1722-0674	1722-0672	-	1721-0098
Zach Ness Vegas 08-12	1721-1952	1721-1948	SDP-922HH	DP-118	FA347HH	FA196HH	1722-0674	1722-0672	-	1721-0098
Vegas Ness Signature 05-07	1721-1950	1721-1949	SDP-630HH	DP623	FA244HH	FA209/2HH	1722-0673	1722-0672	-	-
Vegas Ness Signature 10-11	1721-1952	1721-1948	SDP-922HH	DP-118	FA347HH	FA196HH	1722-0674	1722-0672	-	1721-0098
Touring Cruiser 03-05	1721-1950	1721-1949	SDP-630HH	DP623	FA244HH	FA209/2HH	1722-0673	1721-1485	784CM55	780SM15
Vision 8-Ball 10-11	1721-1951	1721-1948	SDP-124HH	DP-118	FA261HH	FA196HH	1722-0671	1722-0672	-	1721-0098
Vision Street/Tour 08-16 (all)	1721-1951	1721-1948	SDP-124HH	DP-118	FA261HH	FA196HH	1722-0671	1722-0672	-	1721-0098

BRAKE PADS



- Sintered metal brake pads are the OEM-type replacement pads for most bikes from the late 1970s to the present
- Sintered metal brake pads are proudly made in the U.S.A.; second-to-none in their stopping abilities and wear characteristics, while still providing excellent reduction in noise and dust
- Organic pads are OEM type replacement brake pads for 1970s and earlier models
- Organic pads with aramid high-performance fibers are the perfect choice for polished or chromed rotors and billet steel rotors
- Semi-metallic brake pads offer a pad in between both the sintered and organic brake pad compounds
- All compounds of Drag Specialties brake pads are asbestos-, nickel- and lead-free

NOTE: Pads are 8mm thick.

NOTE: If you are using aftermarket billet steel rotors, it is recommended you use our Organic pads with Aramid high-performance fiber brake pads to avoid damage to them. Sintered pads are not recommended for billet steel rotors as the pad material is too aggressive for those rotors.



FITS CALIPER	DESCRIPTION	PART #	FITS CALIPER	DESCRIPTION	PART #	FITS CALIPER	DESCRIPTION	PART #
PERFORMANCE MACHINE			PERFORMANCE MACHINE (CONT)			PERFORMANCE MACHINE (CONT)		
125 X 4R (0052-1602)	Sintered metal	1721-1360	137 X 4B (0052-1602)	Sintered metal	1721-1360	125 X 4RSPH (0052-1602)	Sintered metal	1721-1360
	Organic	1720-0209		Organic	1720-0209		Organic	1720-0209

BRAKE PAD CROSS-REFERENCE CHART

SINTERED METAL PAD PART #	SEMI-METALLIC PART #	ORGANIC PAD PART #	SINTERED METAL PAD PART #	SEMI-METALLIC PART #	ORGANIC PAD PART #
1721-1360	-	1720-0209	1721-1950	1721-2255	1720-0280
1721-1948	1721-2257	1720-0278	1721-1951	1721-2256	-
1721-1949	-	1720-0279	1721-1952	-	-

PRICE LIST

PART #	SUG. RETAIL	PART #	SUG. RETAIL	PART #	SUG. RETAIL	PART #	SUG. RETAIL	PART #	SUG. RETAIL
1720-0209	\$19.95	1720-0280	\$20.95	1721-1949	\$52.95	1721-1952	\$27.95	1721-2257	\$31.95
1720-0278	21.95	1721-1360	33.95	1721-1950	27.95	1721-2255	24.95		
1720-0279	21.95	1721-1948	29.95	1721-1951	34.95	1721-2256	49.95		



Standard Sintered metal brake pads



Sport HH+ Supersport pads



DP BRAKES

THE ORIGINAL SINTERED BRAKES

- DP Brakes brake pads are designed with sintered metal compounds to give your bike high-tech performance in all conditions
- Pads have a quick break-in period so you get maximum performance fast
- DP Brakes design and materials ensure consistent hard stops and fade-free performance
- Sintered metal compounds outlast more conventional organic or Kevlar® pads

STANDARD SINTERED METAL BRAKE PADS

- GG friction rated and made with DP Brakes' proven sintered metal material
- Gray-colored aluminum oxide-based ceramic material on rear of backing plate keeps heat away from caliper piston and fluid in extreme conditions for fade-free performance
- Pad compound gives equal performance in wet or dry conditions
- Ideal replacement for street and touring machines where durability is the prime requirement
- No brake fade

SPORT HH+ SUPERSPORT PADS

- Powerful, industry-high HH+ friction rating with no mileage penalty
- High-tech ceramic heat shield eliminates brake fade
- Dust-free compound design
- Quick break-in so you get maximum braking ability fast
- For front wheel use only

NOTE: For brake pad applications, see chart on page 66.

BRAKE PAD CROSS-REFERENCE CHART

DP BRAKES PAD #	STANDARD PAD PART #	SPORT HH+ PAD PART #
118	DP-118	-
124	-	SDP-124HH
623	DP623	-
630	-	SDP-630HH
922	-	SDP-922HH

PRICE LIST

PART #	SUG. RETAIL	PART #	SUG. RETAIL	PART #	SUG. RETAIL
DP-118	\$48.95	SDP-124HH	\$48.95	SDP-922HH	\$48.95
DP623	48.95	SDP-630HH	48.95		

All part numbers in **BOLD MAGENTA** are new this year.

partsnetweb.com / dragnetweb.com

VICTORY

EXHAUST

LUGGAGE

SECURITY

WINDSHIELDS

FAIRINGS & BODY

SEATS & Sissy BARS

HANDLEBARS & HAND CONTROLS

FOOTPEGS & FOOT CONTROLS

LIGHTING

ELECTRICAL

WHEELS & ACCESSORIES

BRAKES & SUSPENSION

ENGINE

FUEL/AIR SYSTEMS

INDIAN

EXHAUST

WINDSHIELDS

FAIRINGS & BODY

SEATS & Sissy BARS

HANDLEBARS & HAND CONTROLS

FOOTPEGS & FOOT CONTROLS

LIGHTING

ELECTRICAL

WHEELS & BRAKES

SUSPENSION

ENGINE

FUEL/AIR SYSTEMS

VICTORY

EXHAUST

LUGGAGE

SECURITY

WINDSHIELDS

FAIRINGS & BODY

SEATS & Sissy BARS

HANDLEBARS & HAND CONTROLS

FOOTPEGS & FOOT CONTROLS

LIGHTING

ELECTRICAL

WHEELS & ACCESSORIES

BRAKES & SUSPENSION

ENGINE

FUEL/AIR SYSTEMS

INDIAN

EXHAUST

WINDSHIELDS

FAIRINGS & BODY

SEATS & Sissy BARS

HANDLEBARS & HAND CONTROLS

FOOTPEGS & FOOT CONTROLS

LIGHTING

ELECTRICAL

WHEELS & BRAKES

SUSPENSION

ENGINE

FUEL/AIR SYSTEMS



Organic



Double-H Sintered Metal

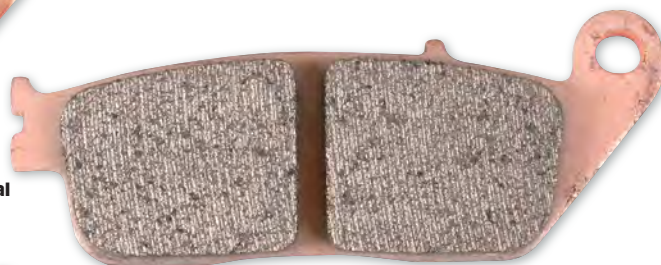

"V" Semi-Sintered



BRAKE PADS AND SHOES ORGANIC BRAKE PADS

- The world's #1 selling organic disc brake pads
- EBC Organic brake pads contain Aramid fibers; these are man-made high-performance fibers used widely for their light weight, high strength, abrasion resistance and thermal stability
- Aramid fibers have high strength-to-weight, thermal stability and abrasion resistance to provide advantages over cheaper steel fiber-based products
- Provide excellent stopping power without noise and rotor galling, even on polished rotors
- Fingertip control and strong, predictable brake response

DOUBLE-H SINTERED METAL PADS

- Feature the HH friction rating – the highest in the industry
- Provide maximum brake effect and last twice as long as organic pads
- Sintered pads are made in the U.S.A.

SEMI-SINTERED "V" PADS

- All-new semi-sintered construction containing 30% copper by weight within an organic matrix
- This design has the long life of a sintered pad with the great feel and are more rotor friendly than the more aggressive sintered pads
- Can be used to replace organic or sintered metal compound pads

NOTE: For brake pad applications see chart on page 66.

BRAKE PAD CROSS-REFERENCE CHART

EBC PAD #	ORGANIC PAD PART #	DOUBLE-H SINTERED METAL PAD PART #	"V" SEMI-SINTERED PAD PART #
196	1720-0021	FA196HH	1721-1411
209/2	FA209/2	FA209/2HH	1721-1415
244	FA244	FA244HH	1721-1453
261	-	FA261HH	-
347	-	FA347HH	-

PRICE LIST

PART #	SUG. RETAIL	PART #	SUG. RETAIL	PART #	SUG. RETAIL
FA196HH	\$38.95	FA244HH	\$38.95	1721-1411	\$34.95
FA209/2	34.95	FA261HH	45.95	1721-1415	56.95
FA209/2HH	45.95	FA347HH	38.95	1721-1453	35.95
FA244	34.95	1720-0021	31.95		



Ceramic



Sintered

SBS BRAKE PADS

- SBS brake pads feature asbestos-free brakes using patented Unified Composite Technology (UCT)
- UCT technology completely blends all brake pad materials into a balanced, unified pad
- This balance ensures no hot spots, glazing, premature fading or excessive rotor wear
- The result is powerful, fade-free braking performance, even in extreme conditions

STREET CERAMIC PADS

- Designed for flawless performance on all street bikes NOT factory-equipped with sintered metal pads
- Provide strong stopping power no matter what the conditions
- Street Ceramic pads can replace sintered pads; however, STREETExcel sintered pads are recommended for those applications

STREETEXCEL SINTERED METAL PADS

- The best in sintered replacement pads for high-performance front (HS) and rear (LS) street applications
- Use advanced sintering process technology; perfect for sport riding
- The highest coefficient of friction in the lineup to provide maximum stopping power
- Formulation also offers high fade-resistance and quick cool-down under severe braking
- When you need to replace your worn sintered metal pads, choose STREETExcel; the sinter compounds with the power to stop you

NOTE: For brake pad applications, see chart on page 66.

BRAKE PAD CROSS-REFERENCE CHART

SBS PAD #	STREET CERAMIC PART #	HS STREETEXCEL SINTERED METAL FRONT PAD PART #	LS STREETEXCEL SINTERED METAL REAR PAD PART #
630	-	-	1722-0672
674	-	-	1721-1485
706	1721-1483	1722-0673	-
735	-	1721-0671	-
782	-	1722-0674	-

PRICE LIST

PART #	SUG. RETAIL	PART #	SUG. RETAIL	PART #	SUG. RETAIL
1721-1483	\$33.95	1722-0671	\$44.95	1722-0673	\$41.95
1721-1485	46.95	1722-0672	41.95	1722-0674	41.95

All part numbers in **BOLD MAGENTA** are new this year.

partsnetweb.com / dragnetweb.com

VICTORY

EXHAUST

LUGGAGE

SECURITY

WINDSHIELDS

FAIRINGS & BODY

SEATS & SIGNS

HANDLEBARS & HAND CONTROLS

FOOTPEGS & FOOT CONTROLS

LIGHTING

ELECTRICAL

WHEELS & ACCESSORIES

BRAKES & SUSPENSION

ENGINE

FUEL/AIR SYSTEMS

INDIAN

EXHAUST

WINDSHIELDS

FAIRINGS & BODY

SEATS & SIGNS

HANDLEBARS & HAND CONTROLS

FOOTPEGS & FOOT CONTROLS

LIGHTING

ELECTRICAL

WHEELS & BRAKES

SUSPENSION

ENGINE

FUEL/AIR SYSTEMS

VICTORY

EXHAUST

LUGGAGE

SECURITY

WINDSHIELDS

FAIRINGS & BODY

SEATS & Sissy BARS

HANDLEBARS & HAND CONTROLS

FOOTPEGS & FOOT CONTROLS

LIGHTING

ELECTRICAL

WHEELS & ACCESSORIES

BRAKES & SUSPENSION

ENGINE

FUEL/AIR SYSTEMS

INDIAN

EXHAUST

WINDSHIELDS

FAIRINGS & BODY

SEATS & Sissy BARS

HANDLEBARS & HAND CONTROLS

FOOTPEGS & FOOT CONTROLS

LIGHTING

ELECTRICAL

WHEELS & BRAKES

SUSPENSION

ENGINE

FUEL/AIR SYSTEMS



HIGH-PERFORMANCE BRAKE PADS

- All Braking® brake pads are asbestos- and nickel-free
- Other brake companies stress friction over other performance factors – Braking uses an organic base material for outstanding friction along with a soft, non-aggressive metal that allows the pad to glide on the disc, providing better control
- All Braking brake pads are compatible with cast iron, stainless steel and Carbrion® materials and, when used with Braking rotors, provide the greatest control and braking power available

SM1 COMPOUND

- Semi-metallic compound – great OE replacement-type pad
- Best performance at lower temperatures
- Offers an aggressive response and is easily identified by the black backing plate

FRONT CM55 COMPOUND

- Universal, sintered metal compound that is a great OEM upgrade
- Offers a powerful initial bite and also a longer pad life
- Good pad choice for all types of street sport riding conditions

CM66 COMPOUND

- Unique Braking semi-metallic compound formulated for the most demanding street riding and/or racing conditions
- Provides a very aggressive initial bite combined with a positive lever feeling
- Best performance obtained in higher temperatures

NOTE: For brake pad applications, see chart on pages 66.

Front CM55 Compound



CM66 Compound



SM1 Compound

BRAKE PAD CROSS-REFERENCE CHART

PAD #	SM1 COMPOUND PART #	CM55 COMPOUND PART #	CM66 COMPOUND PART #
716	1721-0098	-	-
780	780SM15	1721-1790	-
784	-	784CM55	784CM66

PRICE LIST

PART #	SUG. RETAIL	PART #	SUG. RETAIL	PART #	SUG. RETAIL
1721-0098	\$26.95	780SM15	\$31.95	784CM66	\$83.95
1721-1790	42.95	784CM55	44.95		



GOLD-PLUS BRAKE PADS

- LRB's latest advancement in high-performance friction materials
- Racing formula offers extreme stopping power in both wet and dry conditions
- Dust and rotor wear are eliminated
- Proprietary blend of organics and trace iron requires no break-in
- Sold in pairs; order two pairs for dual-disc applications
- Made in the U.S.A.

Z-PLUS BRAKE PADS

- A matrix of carbon/Kevlar® and non-ferrous metal similar to LRB's Gold-Plus Pads in stopping performance, but softened slightly to provide longer service life in the lower temperature ranges found in common street use
- Dust-free, quiet and the best protection for polished rotors
- Ultra-long service life

XTREME BRAKE PADS

- Utilize the latest technology in high-performance aramids by DuPont®
- The first organic pads to achieve an H/H friction level
- X-treme Performance Brake Pads deliver predictable, repeatable performance in the most-demanding riding environments, mountains, canyons, even track days
- Ideal for high-performance motorcycles and/or heavy-duty touring
- High-torque stopping power
- Rotor friendly, won't scratch your disc
- Zero dust, zero noise
- 15,000 service miles
- Fit composite or steel rotors
- Work well hot or cold, wet or dry
- Made in the U.S.A.



1720-0061



1720-0062



1720-0044

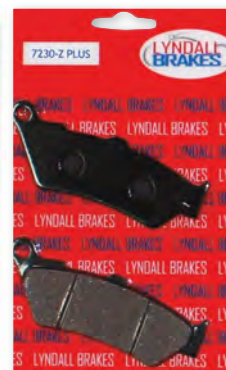

1720-0046



1720-0527



1720-0521

FITS MODEL	POSITION	GOLD-PLUS	SUG. RETAIL	Z-PLUS	SUG. RETAIL	XTREME	SUG. RETAIL	
VICTORY	All models 98-07	Front	1720-0061	\$66.95	1720-0044	\$51.95	1720-0519	\$79.95
		Rear	1720-0062	66.95	1720-0046	51.95	1720-0527	79.95
Hammer, Jackpot, Vegas 08-14	Front	-	-	-	-	1720-0520	79.95	
	Front	-	-	-	-	1720-0522	79.95	
Vision 08-14	Front	-	-	-	-	1720-0522	79.95	
	Rear	-	-	-	-	1720-0521	79.95	

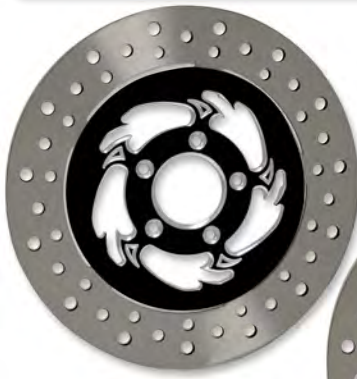

Savage Eclipse



Savage Chrome



Majestic Eclipse

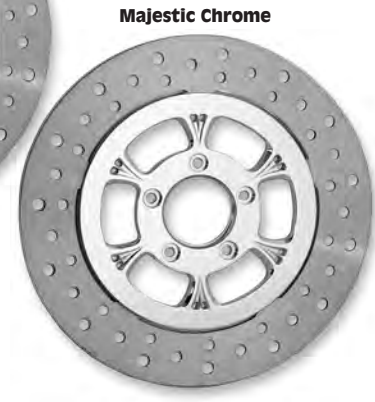

Majestic Chrome

FLOATING FRONT BRAKE ROTORS FOR VICTORY CROSS ROADS, CROSS COUNTRY 10-14 (NON-ABS)



- Two-piece high-quality billet aluminum rotors are wrapped with a stainless steel band
- CNC-machined and quality tested to ensure a superior product
- Provides improved feel and stronger braking
- Rotors match RC Components wheels
- Made in the U.S.A.

DESCRIPTION	SAVAGE ECLIPSE	SAVAGE CHROME	MAJESTIC ECLIPSE	MAJESTIC CHROME
11.8" Left front	1710-1323¹	1710-1321¹	1710-2399¹	1710-2401¹
11.8" Right front	1710-1324¹	1710-1322¹	1710-2400¹	1710-2402¹
11.5" Right rear	1710-2395²	1710-2396²	1710-2397²	1710-2398²

¹ Requires purchase of rotor bolts PART #2401-0313, SUG. RETAIL \$10.95.

² Requires purchase of rotor bolts PART #2401-0314, SUG. RETAIL \$10.95.

BRAKE ROTOR PRICE LIST

PART #	SUG. RETAIL	PART #	SUG. RETAIL	PART #	SUG. RETAIL	PART #	SUG. RETAIL
1710-1321	\$349.95	1710-1324	\$349.95	1710-2397	\$339.95	1710-2400	\$339.95
1710-1322	349.95	1710-2395	339.95	1710-2398	339.95	1710-2401	339.95
1710-1323	349.95	1710-2396	339.95	1710-2399	339.95	1710-2402	339.95



PRO-LITE BRAKE ROTORS

- Complete bolt-on and go rotor assemblies
 - Made with forged aluminum center hubs, high-friction billet steel rotor rings and sturdy riveted construction
 - Excellent choice when upgrading or replacing OEM brake rotors
 - Solid mount
 - Sold each
- SUG. RETAIL \$225.95**

FITS MODEL	FRONT LEFT ROTOR PART #	FRONT RIGHT ROTOR PART #	REAR ROTOR PART #
VICTORY			
V92C (All models single front rotor) 98-03	1710-1476	-	1710-1476
V925C 00-03	1710-1476	1710-1476	1710-1476
Cory Ness Victory Cross Country 11-12	-	-	1710-1475
Ness Signature Series 05-07	1710-1475	-	1710-1475
Cross Country 10-16	-	-	1710-1475
Cross Roads 10-12	-	-	1710-1475
Gunner 15-16	-	-	1710-1475
Hammer 05-07	1710-1475	1710-1475	1710-1475
Hammer 08-11	1710-1475	1710-1475	1710-1475
Hammer 8 Ball 10-16	1710-1475	1710-1475	1710-1475
Hammer S 07	1710-1475	1710-1475	1710-1475
Hammer S 08-16	1710-1475	1710-1475	1710-1475
Hard Ball 12-14	1710-1475	1710-1475	1710-1475
Jackpot 10-14	1710-1475	-	1710-1475
Cory Ness Jackpot 08-10	1710-1475	-	1710-1475
Judge 12-16	1710-1475	-	1710-1475
Kingpin 04-07	1710-1475	-	1710-1475
Kingpin 08-12	1710-1475	-	1710-1475



FITS MODEL	FRONT LEFT ROTOR PART #	FRONT RIGHT ROTOR PART #	REAR ROTOR PART #
VICTORY (CONT)			
Kingpin Tour 04-07	1710-1475	-	1710-1476
Kingpin Tour 08-09	1710-1475	-	1710-1475
Kingpin 8-Ball 08-11	1710-1475	-	1710-1475
Kingpin Low 09	1710-1475	-	1710-1475
Magnum 15-16	-	-	1710-1475
Vegas 03-07	1710-1475	-	1710-1475
Vegas 08-16	1710-1475	-	1710-1475
Vegas 8-Ball 05-07	1710-1475	-	1710-1475
Vegas 8-Ball 08-16	1710-1475	-	1710-1475
Vegas Jackpot 06-07	1710-1475	-	1710-1475
Vegas Jackpot 08-12	1710-1475	-	1710-1475
Zach Ness Vegas 11	1710-1475	-	1710-1475
Vegas Low 08-09	1710-1475	-	1710-1475
Vision 8 Ball 10-11	1710-1475	1710-1475	1710-1475
Vision Street 08-09	1710-1475	1710-1475	1710-1475
Vision Tour 08-16 (all)	1710-1475	1710-1475	1710-1475
Arlen Ness Victory Vision 10-12	1710-1475	1710-1475	1710-1475

All part numbers in **BOLD MAGENTA** are new this year.

VICTORY

EXHAUST

LUGGAGE

SECURITY

WINDSHIELDS

FAIRINGS & BODY

SEATS & Sissy BARS

HANDLEBARS & HAND CONTROLS

FOOTPEGS & FOOT CONTROLS

LIGHTING

ELECTRICAL

WHEELS & ACCESSORIES

BRAKES & SUSPENSION

ENGINE

FUEL/AIR SYSTEMS

INDIAN

EXHAUST

WINDSHIELDS

FAIRINGS & BODY

SEATS & Sissy BARS

HANDLEBARS & HAND CONTROLS

FOOTPEGS & FOOT CONTROLS

LIGHTING

ELECTRICAL

WHEELS & BRAKES

SUSPENSION

ENGINE

FUEL/AIR SYSTEMS

465 SERIES SHOCKS



- High-pressure gas monotube design for the ultimate performance
- Five-position rebound adjustment to tailor the suspension for changing conditions and riding styles
- Threaded shock body with a wide range of adjustment to fine-tune preload and sag
- Hard anodized aluminum body and components for excellent durability and corrosion resistance
- 46mm bore and defluctive disc piston provides precise damping
- 16mm hard chrome shaft rides on custom viton seals for low friction and leak-free reliability
- Each shock is custom tuned (damping and spring rate) for each fitment
- Made in the U.S.A.



1310-0611

NOTE: Before purchasing or attempting to install shocks that are different than the OEM length, confirm that your wheel travel can be altered without causing clearance issues such as swingarm/axle to exhaust contact as well as chain/belt guard or tire contact.

SUG. RETAIL **\$494.95**

FITS MODEL	LENGTH	PART #
VICTORY		
Boardwalk 13-14	Stock	1310-0610
	1" lower	1310-0611
Hammer 05-12	Stock	1310-0610
	1" lower	1310-0611
Hammer 8-Ball 13-14	Stock	1310-0610
	1" lower	1310-0611

FITS MODEL	LENGTH	PART #
VICTORY (CONT)		
Highball 12-14	Stock	1310-0610
	1" lower	1310-0611
Jackpot 06-14	Stock	1310-0610
	1" lower	1310-0611
Judge 13-14	Stock	1310-0610
	1" lower	1310-0611

FITS MODEL	LENGTH	PART #
VICTORY (CONT)		
Kingpin 04-12	Stock	1310-0610
	1" lower	1310-0611
Vegas 03-12	Stock	1310-0610
	1" lower	1310-0611
Vegas 8-Ball 13-14	Stock	1310-0610
	1" lower	1310-0611

BRAIDED FRONT BRAKE LINES



- The Industry's highest-quality braid available in two colors to complement your bike; Sterling Chromite II® and Black Pearl braided with black wire
- Braid color and weave match on all Magnum control cables and brake lines
- E-Z Align rotating caliper banjo feature for perfect no-kink fitments
- Dual-Disc Brake Kits consist of direct-fit lower assemblies used in conjunction with alternative-length upper lines
- Adapters and upper brake lines have -3AN connections for easy installations
- All fittings are polished and chrome or black chrome plated
- Crystal-clear outer jacket offers exceptional protection against scuffing paint or chrome and will never discolor
- Kevlar® braided inner PTFE tubing greatly reduces line expansion, providing the ultimate in high performance
- Exceeds all DOT FMVSS-106 Specifications
- Made in the U.S.A.

NOTE: Dual-disc upper and lower brake line kits are sold separately; lower brake line is optional.
NOTE: An adapter is required to connect the upper brake line to the lower. See chart.

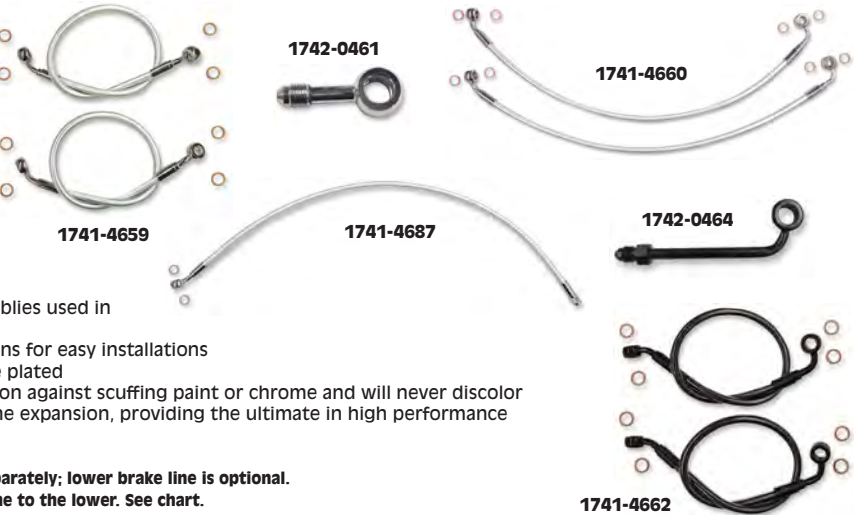

STERLING CHROMITE II

FITS MODEL	DESCRIPTION	OEM #	STOCK	+2"	+4"	+6"	+8"
VICTORY							
Cross Country 10-16 (non-ABS), Cross Roads 10-14 (non-ABS)	Lower Brake Lines	1911361+ 1911360	1741-4659	-	-	-	-
	Upper Brake Line (requires upper adapter)	1911364	1741-4689	1741-4691	1741-4693	1741-4695	1741-4696
	Upper Adapter	1911364	1742-0461	-	-	-	-
Boardwalk 13-14, Gunner 15-16, Hammer 10-16, Jackpot 08-16, Judge 14, Kingpin 08-12, Vegas 08-16	Single Disc Brake Line	1911192	1741-4665	1741-4666	1741-4667	1741-4668	1741-4669
Highball 12-16	Single Disc Brake Line	1911713	1741-4671	1741-4672	1741-4673	1741-4674	-
Judge 13	Single Disc Brake Line	1911871	1741-4663	1741-4664	1741-4665	1741-4666	1741-4667
Hammer S 08-16	Lower Brake Lines	1911088 + 1911089	1741-4660	-	-	-	-
	Upper Brake Line (requires upper adapter)	1911202	1741-4687	1741-4688	1741-4690	1741-4692	1741-4694
	Upper Adapter	1911202	1742-0462	-	-	-	-

BLACK PEARL

FITS MODEL	DESCRIPTION	OEM #	STOCK	+2"	+4"	+6"	+8"
VICTORY							
Cross Country 10-16 (non-ABS), Cross Roads 10-14 (non-ABS)	Lower Brake Lines	1911361+ 1911360	1741-4661	-	-	-	-
	Upper Brake Line (requires upper adapter)	1911364	1741-4699	1741-4701	1741-4703	1741-4705	1741-4706
	Upper Adapter	1911364	1742-0463	-	-	-	-
Boardwalk 13-14, Gunner 15-16, Hammer 10-16, Jackpot 08-16, Judge 14, Kingpin 08-12, Vegas 08-16	Single Disc Brake Line	1911192	1741-4677	1741-4678	1741-4679	1741-4680	1741-4681
Highball 12-16	Single Disc Brake Line	1911713	1741-4683	1741-4684	1741-4685	1741-4686	-
Judge 13	Single Disc Brake Line	1911871	1741-4675	1741-4676	1741-4677	1741-4678	1741-4679
Hammer S 08-16	Lower Brake Lines	1911088 + 1911089	1741-4662	-	-	-	-
	Upper Brake Line (requires upper adapter)	1911202	1741-4697	1741-4698	1741-4700	1741-4702	1741-4704
	Upper Adapter	1911202	1742-0464	-	-	-	-

PART #	SUG. RETAIL	PART #	SUG. RETAIL	PART #	SUG. RETAIL	PART #	SUG. RETAIL	PART #	SUG. RETAIL	PART #	SUG. RETAIL
1741-4659	\$79.95	1741-4668	\$73.95	1741-4678	\$71.95	1741-4688	\$56.95	1741-4697	\$55.95	1741-4706	\$61.95
1741-4660	99.95	1741-4669	74.95	1741-4679	72.95	1741-4689	57.95	1741-4698	56.95	1742-0461	14.95
1741-4661	79.95	1741-4671	72.95	1741-4680	73.95	1741-4690	58.95	1741-4699	57.95	1742-0462	22.95
1741-4662	99.95	1741-4672	73.95	1741-4681	74.95	1741-4691	58.95	1741-4700	58.95	1742-0463	14.95
1741-4663	68.95	1741-4673	75.95	1741-4683	72.95	1741-4692	59.95	1741-4701	58.95	1742-0464	22.95
1741-4664	69.95	1741-4674	75.95	1741-4684	73.95	1741-4693	59.95	1741-4702	59.95		
1741-4665	70.95	1741-4675	68.95	1741-4685	74.95	1741-4694	60.95	1741-4703	59.95		
1741-4666	71.95	1741-4676	69.95	1741-4686	75.95	1741-4695	60.95	1741-4704	60.95		
1741-4667	72.95	1741-4677	70.95	1741-4687	55.95	1741-4696	61.95	1741-4705	60.95		

All part numbers in **BOLD MAGENTA** are new this year.

KURYAKYN

CYLINDER BASE ACCENTS FOR VICTORY CRUISER MODELS 09-16 (EXCEPT 09-10 KINGPIN/VEGAS/ 8-BALL WITH 100" ENGINE) AND CROSS COUNTRY/CROSS COUNTRY TOUR/MAGNUM 10-16, CROSS ROADS 10-14, HARD-BALL 12-13 (EXCEPT VISION)



- Create a smooth transition from the cylinder to the engine case
- Die-cast construction with a brilliant chrome finish
- Easy to install
- Sold in pairs (right and left side accents)

SUG. RETAIL **\$169.99** PART # **0940-1334**



CHROME INNER PRIMARY COVER FOR ALL VICTORY MODELS 99-16 (EXCEPT OCTANE, VISION)

- Bolts directly to outer primary cover and adds the perfect amount of style
- Installs without having to remove outer cover

SUG. RETAIL **\$129.99** PART # **1107-0403**



REAR TRANSMISSION CENTER COVER FOR VICTORY CROSS COUNTRY/CROSS ROADS 10-16

- Covers those unsightly wiring and tubes while adding some style and shine
- Stamped metal construction
- Simple bolt-on installation

SUG. RETAIL	\$99.99
DESCRIPTION	PART #
Satin black	1105-0181
Chrome	1107-0404



SMOOTH V SIDE COVERS FOR VICTORY MODELS 04-16 (EXCEPT BOARDWALK, JUDGE, OCTANE, MAGNUM MODELS)

- Smooth chrome side covers accent the shape of your engine
- Install in minutes for a truly unique look
- Fit both left and right side of the engine
- Sold in pairs

SUG. RETAIL **\$59.99** PART # **0940-1321**

DISCLAIMER: NOT LEGAL FOR SALE OR USE IN CALIFORNIA ON ANY POLLUTION CONTROLLED MOTOR VEHICLES.
SEE PAGE 3 FOR IMPORTANT EMISSION DEFINITIONS AND REGULATORY COMPLIANCE AND WARRANTY INFORMATION.

All part numbers in **BOLD MAGENTA** are new this year.

VICTORY

EXHAUST

LUGGAGE

SECURITY

WINDSHIELDS

FAIRINGS & BODY

SEATS & Sissy BARS

HANDLEBARS & HAND CONTROLS

FOOTPEGS & FOOT CONTROLS

LIGHTING

ELECTRICAL

WHEELS & ACCESSORIES

BRAKES & SUSPENSION

ENGINE

FUEL/AIR SYSTEMS

INDIAN

EXHAUST

WINDSHIELDS

FAIRINGS & BODY

SEATS & Sissy BARS

HANDLEBARS & HAND CONTROLS

FOOTPEGS & FOOT CONTROLS

LIGHTING

ELECTRICAL

WHEELS & BRAKES

SUSPENSION

ENGINE

FUEL/AIR SYSTEMS

VICTORY

EXHAUST

LUGGAGE

SECURITY

WINDSHIELDS

FAIRINGS & BODY

SEATS & SISSY BARS

HANDLEBARS & HAND CONTROLS

FOOTPEGS & FOOT CONTROLS

LIGHTING

ELECTRICAL

WHEELS & ACCESSORIES

BRAKES & SUSPENSION

ENGINE

FUEL/AIR SYSTEMS

INDIAN

EXHAUST

WINDSHIELDS

FAIRINGS & BODY

SEATS & SISSY BARS

HANDLEBARS & HAND CONTROLS

FOOTPEGS & FOOT CONTROLS

LIGHTING

ELECTRICAL

WHEELS & BRAKES

SUSPENSION

ENGINE

FUEL/AIR SYSTEMS



CUSTOM OIL DIPSTICK FOR VICTORY 98-16 (ALL EXCEPT OCTANE)

- Dress up the right side of the Victory with this custom highly polished billet aluminum dipstick
- Easily replaces the unsightly stock one, using the stock O-ring for installation
- Made in the U.S.A.



SUG. RETAIL **\$54.95** PART # **0950-0453**

1130-0102



SCORPION BILLET CLUTCHES

- Feature a 100% or more increase in clutch surface area (compared to stock) and include a CNC-machined billet aluminum pressure plate, friction plates, steel plates, a steel inner hub and additional sets of coil springs to allow for clutch tuning
- Can also be run wet or dry in an open or enclosed primary
- Made in the U.S.A.



SUG. RETAIL **\$549.95**

FITS MODEL	PART #
VICTORY	
All 01-05 (except Hammer)	1130-0102
All 06-07, Hammer 05-07	1130-0103

FITS MODEL	PART #
VICTORY (CONT)	
All models 08-10	1130-0229
All models 11-16 (except Octane)	1130-0230



CARBON FIBER CLUTCH PLATE KIT

- Friction plates feature carbon fiber material for improved clutch feel and performance
- Includes ten frictions, nine steels and one damper spring
- Made in the U.S.A.



SUG. RETAIL **\$207.95**

FITS MODEL	PART #
VICTORY	
Boardwalk 14-15	1131-3026
CA Kingpin 06	1131-3026
Cross Country/Cross Roads (w/ cruise control) 10-12	1131-3026
Cross Country/Touring (w/ cruise control) 10-16	1131-3026
Cross Roads 11	1131-3026
Cross Roads (w/o cruise control) 10-14	1131-3026
Cross Roads (w/ cruise control) 10-16	1131-3026
Hammer 05-16	1131-3026



HEAVY DUTY SPRING AND BILLET PRESSURE PLATE

FOR ALL VICTORY 01-16 MODELS (EXCEPT OCTANE)

- Includes billet aluminum pressure plate and heavy-duty spring
- Direct bolt-on replacement for stock pressure plate and spring
- Ideal for high performance/heavy load applications requiring increased spring pressure
- Made in the U.S.A.



SUG. RETAIL **\$124.95** PART # **1131-3024**

DISCLAIMER: NOT LEGAL FOR SALE OR USE IN CALIFORNIA ON ANY POLLUTION CONTROLLED MOTOR VEHICLES. SEE PAGE 3 FOR IMPORTANT EMISSION DEFINITIONS AND REGULATORY COMPLIANCE AND WARRANTY INFORMATION.



OIL FILTER

- Parts Unlimited oil filters use the world's finest materials, literally: German paper, English glue, and Japanese zinc steel
- All necessary gaskets included
- See application chart on page 76

SUG. RETAIL\$11.95

PART # 0712-0175



OIL FILTER

- High-quality spin-on filter
- A dependable replacement for OEM #2540086
- Available in black
- See application chart on page 76

SUG. RETAIL\$8.95

PART # 0712-0481



FLO STAINLESS STEEL, REUSABLE "SPIN-ON" OIL FILTER

- Made from laser-cut, medical-grade, 304 stainless steel micronic filter cloth, this filter provides 200% more filter area in many cases
- Stainless filter catches items down to 35 microns, which is about three times better than most good paper or brass filters
- Unlike glued paper filters, the FLO Oil Filter pleat seam is welded and able to withstand up to 600° F
- Filter maintains consistent flow under all conditions including extreme heat, the presence of water, and cold start-ups where paper filters can flow so poorly that they often cause the bypass valve to open and allow unfiltered oil to enter your engine
- Should be the last filter an owner ever needs; this high tech filter technology is widely used in all types of auto racing including NASCAR, Indy type cars, Formula 1 and in the aerospace industry where filtration is of the utmost importance
- FLO reference # PCS1
- See application chart on page 76

SUG. RETAIL\$129.95

PART # 0712-0149



PERFORMANCE OIL FILTERS

- Designed to be compatible with modern synthetic and synthetic blended oils
- Synthetic Media allows for the higher-flow rates associated with synthetic and synthetic blended oils
- Large uniform pleated Synthetic Filter Media provides high-capacity and outstanding filtration
- Protected by a heavy-duty canister and base plate, with a double-rolled seal
- 17mm hex nut allows easy-on, easy wrench-off (where applicable)
- Pre-drilled for safety-wire security
- Pressure relief valve and anti-drain back valve (where applicable)
- Pre-lubed base gasket for easy, no-mess installation
- K&N reference #: KN-198
- See application chart on page 76

SUG. RETAIL\$14.95

PART # 0712-0122



DISCLAIMER: NOT LEGAL FOR SALE OR USE IN CALIFORNIA ON ANY POLLUTION CONTROLLED MOTOR VEHICLES. SEE PAGE 3 FOR IMPORTANT EMISSION DEFINITIONS AND REGULATORY COMPLIANCE AND WARRANTY INFORMATION.

All part numbers in **BOLD MAGENTA** are new this year.

- EXHAUST
- LUGGAGE
- SECURITY
- WINDSHIELDS
- FAIRINGS & BODY
- SEATS & SISSY BARS
- HANDLEBARS & HAND CONTROLS
- FOOTPEGS & FOOT CONTROLS
- LIGHTING
- ELECTRICAL
- WHEELS & ACCESSORIES
- BRAKES & SUSPENSION
- ENGINE
- FUEL/AIR SYSTEMS
- INDIAN
- EXHAUST
- WINDSHIELDS
- FAIRINGS & BODY
- SEATS & SISSY BARS
- HANDLEBARS & HAND CONTROLS
- FOOTPEGS & FOOT CONTROLS
- LIGHTING
- ELECTRICAL
- WHEELS & BRAKES
- SUSPENSION
- ENGINE
- FUEL/AIR SYSTEMS

VICTORY

EXHAUST

LUGGAGE

SECURITY

WINDSHIELDS

FAIRINGS & BODY

SEATS & SISSY BARS

HANDLEBARS & HAND CONTROLS

FOOTPEGS & FOOT CONTROLS

LIGHTING

ELECTRICAL

WHEELS & ACCESSORIES

BRAKES & SUSPENSION

ENGINE

FUEL/AIR SYSTEMS

INDIAN

EXHAUST

WINDSHIELDS

FAIRINGS & BODY

SEATS & SISSY BARS

HANDLEBARS & HAND CONTROLS

FOOTPEGS & FOOT CONTROLS

LIGHTING

ELECTRICAL

WHEELS & BRAKES

SUSPENSION

ENGINE

FUEL/AIR SYSTEMS



FRAM

MOTORCYCLE OIL FILTER

- Dependable Fram protection for your motorcycle engine
- Complete change kit; all gaskets included
- See application chart below

SUG. RETAIL\$10.95

PART # PH6017



HIFLOFILTRO

HIFLOFILTRO® OIL FILTER

- The original Hiflofiltro factory was founded in 1955 and has been manufacturing filters for the OEM motor industry since 1963
- With the experience of more than five decades, constant research and development and featuring a completely modern production facility Hiflofiltro offers some of the best quality filters in the world
- TUV approved and production monitored to ensure OEM or better quality
- Constructed using the best materials available
- One of the broadest ranges of aftermarket coverage
- Hiflofiltro reference #: HF198
- See application chart below

SUG. RETAIL\$8.65

PART # 0712-0114

OIL FILTER APPLICATION CHART

FITS MODEL	PARTS UNLIMITED PART #	DRAG SPECIALTIES PART #	K&N PART #	HIFLOFILTRO PART #	FRAM PART #	PC RACING FLO PART #
VICTORY						
Boardwalk 13-15	0712-0173	0712-0481	0712-0122	0712-0114	PH6017	0712-0149
Cruiser 95-05	0712-0173	0712-0481	0712-0122	0712-0114	PH6017	0712-0149
Classic Cruiser 03	0712-0173	0712-0481	0712-0122	0712-0114	PH6017	0712-0149
Cross Country/Cross Roads 12-16 (all)	0712-0173	0712-0481	0712-0122	0712-0114	PH6017	0712-0149
Deluxe Cruiser/Deluxe Touring Cruiser 02	0712-0173	0712-0481	0712-0122	0712-0114	PH6017	0712-0149
Gunner 15-16	0712-0173	0712-0481	0712-0122	0712-0114	PH6017	0712-0149
Hammer 06-16 (all)	0712-0173	0712-0481	0712-0122	0712-0114	PH6017	0712-0149
Hardball 13-14	0712-0173	0712-0481	0712-0122	0712-0114	PH6017	0712-0149
Highball 11-16	0712-0173	0712-0481	0712-0122	0712-0114	PH6017	0712-0149
Jackpot 09-16 (all)	0712-0173	0712-0481	0712-0122	0712-0114	PH6017	0712-0149
Judge 13-16	0712-0173	0712-0481	0712-0122	0712-0114	PH6017	0712-0149
Kingpin 03-13 (all)	0712-0173	0712-0481	0712-0122	0712-0114	PH6017	0712-0149
Magnum/Magnum Ness 15	0712-0173	0712-0481	0712-0122	0712-0114	PH6017	0712-0149
Magnum/Magnum X-1 16	0712-0173	0712-0481	0712-0122	0712-0114	PH6017	0712-0149
Standard Cruiser 02	0712-0173	0712-0481	0712-0122	0712-0114	PH6017	0712-0149
Touring Cruiser 02-07	0712-0173	0712-0481	0712-0122	0712-0114	PH6017	0712-0149
V92C 98-02	0712-0173	0712-0481	0712-0122	0712-0114	PH6017	0712-0149
Vegas 06-16 (all)	0712-0173	0712-0481	0712-0122	0712-0114	PH6017	0712-0149
Victory Vegas 03-06	0712-0173	0712-0481	0712-0122	0712-0114	PH6017	0712-0149
Vision 09-16 (all)	0712-0173	0712-0481	0712-0122	0712-0114	PH6017	0712-0149

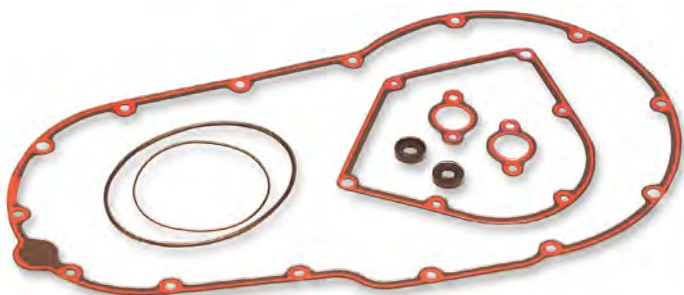

0934-4610



0934-4644

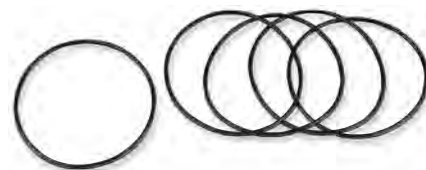

0934-4645

Genuine
JAMES GASKETS

GASKETS, SEALS AND O-RINGS

- Quality James Gaskets
- Made in the U.S.A.

FITS MODEL	DESCRIPTION	PART #	SUG. RETAIL
VICTORY			
99-16 models	Primary chain cover and cam chain service gasket and seal kit	0934-4610	\$41.95
03-16 models	O-ring, derby cover cap plate	0934-4644	1.95
99-02 models	O-ring, derby cover, 3-hole	0934-4645	2.95

DISCLAIMER: NOT LEGAL FOR SALE OR USE IN CALIFORNIA ON ANY POLLUTION CONTROLLED MOTOR VEHICLES. SEE PAGE 3 FOR IMPORTANT EMISSION DEFINITIONS AND REGULATORY COMPLIANCE AND WARRANTY INFORMATION.



POWER COMMANDER V

- Fuel control for each individual cylinder in a smaller enclosure
- "Warm-up" fuel adjustment (unit reads engine temp and allows fuel/timing adjustments based on the reading)
- All applications include ignition adjustment feature; allows full ignition timing control of each cylinder
- Reduced size from the PCIII USB
- Easy to install
- USB powered from computer; 9 volt adapter is no longer needed
- Two-position map-switching function built in
- Can add any Single Pole Single Throw (SPST) switch and toggle between two different fuel maps
- Gear/speed input allows for map adjustment based on gear
- Analog input allows user to install any 0-5 volt sensor
- Build an adjustment table based on analog input such as boost or temperature
- Power Commander V is capable of allowing each cylinder to be mapped individually and for each gear with the gear position input connected
- More tuning ranges than PCIII USB
- Enhanced "accel pump" utility
- Made in the U.S.A.



FITS MODEL	PART #
VICTORY	
All 100" models 08-11	1020-1015
All 106" models 09-15	1020-1014

FITS MODEL	PART #
VICTORY (CONT)	
All 106" models 16	1020-2598
Crossroads/Cross Country 11-15	1020-1537

SUG. RETAIL **\$399.95**

FITS MODEL	PART #
VICTORY (CONT)	
Vision 09-15	1020-1016
Crossroads/Cross Country 16	1020-2616

POWER COMMANDER III USB

- USB (Universal Serial Bus) port provides an instant and automatic connection to the Power Commander Control Center software; simply power up the unit and connect the PCIII USB to the computer with the supplied cable
- Provides precise information for fine-tuning a fuel-injected motorcycle when changing an air filter, installing a new exhaust system or doing additional engine performance modifications
- Each unit includes a built-in microprocessor and a specific map designed to improve engine performance over stock; Dynojet continuously maps new calibrations for each bike for downloading at their web site (www.powercommander.com)
- If you do not have a computer, you can change the settings with three touch buttons on the faceplate
- OEM-style wiring connectors with improved harness protection are supplied; no wiring modifications required
- Includes easy-to-follow instructions
- Direct injector control technology manages the fuel curve on models that do not have the sensors to monitor fuel adjustment
- Features an expansion port for future add-on modules from Dynojet
- Software is compatible with Windows 2000/XP/Vista and Windows 7
- USB special cable and 9V battery power adapter are included
- Made in the U.S.A.



FITS MODEL	PART #
VICTORY	
Hammer 05-07	1020-0237

FITS MODEL	PART #
VICTORY (CONT)	
V92C 99-01	1020-0128

FITS MODEL	PART #
VICTORY (CONT)	
V92SC 00-01	1020-0129

SUG. RETAIL **\$369.99**

FITS MODEL	PART #
VICTORY (CONT)	
Vegas/Kingpin 03-07	1020-0130



POD-300 DIGITAL DISPLAY

- Real time fuel adjustment
- Display channels real-time: RPM, TP, map position (when using map switch), duty cycle, fuel exchange, ignition change and wideband air/fuel ratio (w/ WB2 or auto-tune connected)
- Weather resistant for use in all conditions
- Log channels saved to internal memory and can be viewed/analyzed with Dynojet's powercore software
- High contrast display, viewable in sunlight
- Includes CAN cable for attachment to Power Commander V, Auto Tune and Wide Band Power Commander

NOTE: Not for use with Power Commander III USB.

SUG. RETAIL **\$249.95**

PART #	PART #
1020-2371	



POWER COMMANDER V MAP SELECT SWITCH

- Switches between two different maps that have been pre-loaded in a Power Commander V
- Comes with a switch, wiring and instructions
- Universal mount

SUG. RETAIL **\$49.95**

PART #	PART #
1020-2082	

DISCLAIMER: NOT LEGAL FOR SALE OR USE IN CALIFORNIA ON ANY POLLUTION CONTROLLED MOTOR VEHICLES. SEE PAGE 3 FOR IMPORTANT EMISSION DEFINITIONS AND REGULATORY COMPLIANCE AND WARRANTY INFORMATION.

All part numbers in **BOLD MAGENTA** are new this year.

VICTORY

EXHAUST

LUGGAGE

SECURITY

WINDSHIELDS

FAIRINGS & BODY

SEATS & Sissy BARS

HANDLEBARS & HAND CONTROLS

FOOTPEGS & FOOT CONTROLS

LIGHTING

ELECTRICAL

WHEELS & ACCESSORIES

BRAKES & SUSPENSION

ENGINE

FUEL/AIR SYSTEMS

INDIAN

EXHAUST

WINDSHIELDS

FAIRINGS & BODY

SEATS & Sissy BARS

HANDLEBARS & HAND CONTROLS

FOOTPEGS & FOOT CONTROLS

LIGHTING

ELECTRICAL

WHEELS & BRAKES

SUSPENSION

ENGINE

FUEL/AIR SYSTEMS

TECHNORESEARCH



CENTURION SUPER PRO PLUS PROFESSIONAL DIAGNOSTIC TOOL SYSTEM

- The industry's only complete professional diagnostic tool system designed for independent professional repair facilities
- Communicates with all 08-17 Victory, 03-17 Indian, 97-15 Harley-Davidson® and Buell models using the proprietary VCM-TR3 Communication Module with included cables
- Re-flash blank ECU, program VIN and Key Fobs on Harley models
- Easily perform speedometer calibration on all Harley models through 2015
- ABS bleeding and ABS solenoid-pump testing on Harley models
- Read and clear Diagnostic Trouble Codes (DTC)
- Reset air/fuel values and adjust idle rpm on Harley models
- Perform active tests on tachometer, speedometer, fuel pump, idle rpm, system relays, cooling fans, IAC, ACR compression, injectors, indicator lights, coils, coolant pump, left or right turn signals and more on Harley models
- LED indicator tests for 6th gear, ABS service, battery, check engine, cruise control, high and low beam, neutral, oil, security and coolant temp on Harley models
- View real-time data in strip chart or digital dashboard formats
- Requires use of a Windows laptop, PC or tablet; connect using either included cable or Bluetooth® wireless connection
- Fast data acquisition and many hours of data storage provides accuracy and saves time
- Can easily update software online through Technoresearch to stay current on all features, years and model types
- Included VCM-TR3 Communication Module is fully compatible with Direct Link & Tune Builder keys (sold separately)
- Includes Mobile Dyno with Android app
- Durable metal housing and easy adapter system allowing for fast switches between motorcycles
- Made in the U.S.A.



SUG. RETAIL \$2,126.95

PART #

3807-0314

TECHNORESEARCH

MAXIMUS

MAXIMUS VICTORY TUNER

- Most advanced, easy-to-operate flash tuning tool for all Victory 08-17 with Visteon ECU/ECM
- Utilizes advanced hardware and software specifications to combine the most commonly used features from the Centurion Super Pro Plus professional diagnostics tool as well as the Direct Link professional flash tuning tool
- Tuning features include the ability to modify front and rear cylinder fuel/spark tables separately, air/fuel ratio, rev limiter and more
- Diagnostic features include read and clear diagnostic trouble codes (DTC)
- Utilizes Bluetooth communication via a Windows-based PC laptop, smart phone or tablet and includes easy to use Android app
- Made in the U.S.A.



SUG. RETAIL \$448.95

PART #

1020-2650

DISCLAIMER: NOT LEGAL FOR SALE OR USE IN CALIFORNIA ON ANY POLLUTION CONTROLLED MOTOR VEHICLES. SEE PAGE 3 FOR IMPORTANT EMISSION DEFINITIONS AND REGULATORY COMPLIANCE AND WARRANTY INFORMATION.

TECHNO RESEARCH



TUNE BUILDER

- Tune Builder is an easy-to-use, professional tuning aid that saves up to 50% of the time needed to create mapping
- Quickly combines current map information with using its powerful data collection and sophisticated algorithms to automatically create tables that allows users to copy/paste completed maps into flash tuning software
- After data is collected from a motorcycle ECU, Tune Builder's Auto Mapping feature automatically generates fuel tables to create the most efficient map possible
- Can be used with all flash tuning software regardless of brand, including OE and aftermarket products
- Effortlessly tune Volumetric Efficiency (VE) tables, detect and remove spark knock and evaluate engine usage areas
- Log up to 16 channels simultaneously and at high frequency
- Record and seamlessly integrate any O₂ sensor device into data collection
- Can utilize the motorcycle's stock narrow band O₂ sensors (if equipped)
- View 3D plots in a grid or in color and view statistics on collected data
- View and adjust tables simply
- Easy to apply manual corrections of VE and spark tables
- Can apply changes to front and rear tables simultaneously
- Keys are available with either 5 or 10 licenses; one license used per motorcycle
- Made in the U.S.A.

NOTE: PART #1020-2409 includes VCM-TR3 communication hardware and cables. License keys need to be purchased separately.

NOTE: If you have a Centurion Super Pro or Centurion Super Pro Plus, PART #1020-2409 is NOT needed.

DESCRIPTION	PART #	SUG. RETAIL	DESCRIPTION	PART #	SUG. RETAIL
Tune Builder VCM (does not include keys)	1020-2409	\$713.95	Tune Builder License key w/ ten licenses	1020-2414	\$85.95 (ea.)
Tune Builder License Key w/ five licenses	1020-2413	85.95 (ea.)			

1020-2409



1020-2413

TECHNO RESEARCH

TRO₂ WIDEBAND AIR/FUEL RATIO SYSTEM

- Essential tuning assistant designed to be used with data logging systems such as a dyno or the Mobile Dyno feature from TechnoResearch found in Centurion Pro, Centurion Pro Plus and Tune Builder
- Includes two Bosch LSU 4.2 O₂ sensors with 7 foot long cables for easy and versatile usage
- Interfaces directly with any TechnoResearch VCM-TR3 communication module found with products such as Tune Builder, Centurion Pro, Centurion Pro Plus
- No calibration required with digital precision
- 12 volt DC power input required
- Made in the U.S.A.

SUG. RETAIL **\$569.95** PART # **3807-0343**



TECHNO RESEARCH

VICTORY/INDIAN CENTURION PRO UPGRADE KIT

- Kit includes all cables and hardware needed to upgrade a Centurion Pro kit (PART # 3807-0313) to include Victory and Indian features
- Activation code included inside package to easily unlock features
- Made in the U.S.A.

SUG. RETAIL **\$428.95** PART # **3807-0344**



DISCLAIMER: NOT LEGAL FOR SALE OR USE IN CALIFORNIA ON ANY POLLUTION CONTROLLED MOTOR VEHICLES. SEE PAGE 3 FOR IMPORTANT EMISSION DEFINITIONS AND REGULATORY COMPLIANCE AND WARRANTY INFORMATION.

All part numbers in **BOLD MAGENTA** are new this year.

partsnetweb.com / dragnetweb.com

VICTORY

EXHAUST

LUGGAGE

SECURITY

WINDSHIELDS

FAIRINGS & BODY

SEATS & SISSY BARS

HANDLEBARS & HAND CONTROLS

FOOTPEGS & FOOT CONTROLS

LIGHTING

ELECTRICAL

WHEELS & ACCESSORIES

BRAKES & SUSPENSION

ENGINE

FUEL/AIR SYSTEMS

INDIAN

EXHAUST

WINDSHIELDS

FAIRINGS & BODY

SEATS & SISSY BARS

HANDLEBARS & HAND CONTROLS

FOOTPEGS & FOOT CONTROLS

LIGHTING

ELECTRICAL

WHEELS & BRAKES

SUSPENSION

ENGINE

FUEL/AIR SYSTEMS

VICTORY

EXHAUST

LUGGAGE

SECURITY

WINDSHIELDS

FAIRINGS & BODY

SEATS & Sissy BARS

HANDLEBARS & HAND CONTROLS

FOOTPEGS & FOOT CONTROLS

LIGHTING

ELECTRICAL

WHEELS & ACCESSORIES

BRAKES & SUSPENSION

ENGINE

FUEL/AIR SYSTEMS

INDIAN

EXHAUST

WINDSHIELDS

FAIRINGS & BODY

SEATS & Sissy BARS

HANDLEBARS & HAND CONTROLS

FOOTPEGS & FOOT CONTROLS

LIGHTING

ELECTRICAL

WHEELS & BRAKES

SUSPENSION

ENGINE

FUEL/AIR SYSTEMS



Fi2000

Fi2000 POWRPRO BLACK

- Requires no dyno tuning – plug it in and ride
- PowrPro Black analyzes, tunes and adjusts your air/fuel ratio for peak performance instantaneously
- Tunes acceleration fuel delivery in every gear for peak performance
- Works with stock or modified engines, air cleaners and exhaust systems
- Can fine-tune the non-acceleration air/fuel curves using the Bluetooth® app
- Can tune engine fuel delivery in specific ranges, check rpm, read fuel injector pulse width and duty cycle, and add or remove fuel in low- or mid-range rpm

SUG. RETAIL **\$499.95**

FITS MODEL	PART #	FITS MODEL	PART #
VICTORY		VICTORY (CONT)	
All models 08-14 (except Cross Country/Cross Roads)	1020-2578	Cruisers 16	1020-2651
Cross Country/Cross Roads 10-16 (all)	1020-2579	Cross Bikes 16	1020-2652



FUEL MANAGEMENT CONTROLLERS

- Simple to use and understand system provides easy air/fuel ratio adjustment
- No computer or dyno required
- Tuning capabilities superior to Alpha N type controllers
- Easily adjusts for modifications – intake, exhaust, cams, etc.
- Easy push-button operation
- Load-based operation
- Three basic zones of operation, similar to a carburetor – one zone sets the “pilot jet” for idle and cruise, another sets the “needle jet” for acceleration and a third zone sets the “main jet” for heavy loading and wide-open throttle
- Plug-and-play installation
- Uses OEM base codes; does not scramble base codes
- Made in the U.S.A.

SUG. RETAIL **\$224.95**

FITS MODEL	PART #	FITS MODEL	PART #
VICTORY		VICTORY (CONT)	
All models 00-07	1020-1099	All models 08-15	1020-1100

DISCLAIMER: NOT LEGAL FOR SALE OR USE IN CALIFORNIA ON ANY POLLUTION CONTROLLED MOTOR VEHICLES. SEE PAGE 3 FOR IMPORTANT EMISSION DEFINITIONS AND REGULATORY COMPLIANCE AND WARRANTY INFORMATION.

All part numbers in **BOLD MAGENTA** are new this year.



OEM-STYLE REPLACEMENT AIR FILTER ELEMENTS

- High-quality paper filter medium
- Meets or exceeds OEM specifications
- For use with OEM stock air filter housings



1011-3520



1011-3521



APPLICATIONS

FITS MODEL	PART #
VICTORY	
Cross Country 11-17	1011-3520
Cross Country 8-Ball 15-16	1011-3520
Cross Roads Custom 11	1011-3520

FITS MODEL	PART #
VICTORY (CONT)	
Cross Roads 12	1011-3520
Cross Roads Classic/Hard Ball 13	1011-3520
Cross Roads Classic/8-Ball 14	1011-3520

FITS MODEL	PART #
VICTORY (CONT)	
Magnum 15-16	1011-3520
Vision 08-17	1011-3521

PRICE LIST

PART #	REPLACES OEM #	SUG. RETAIL	PART #	REPLACES OEM #	SUG. RETAIL
1011-3520	7081648	\$26.95	1011-3521	7081395	\$19.95



STEALTH TWO AIR CLEANER KIT FOR VICTORY OCTANE 17

- One-piece, black molded filter body with blue element
- Element constructed of pleated cotton
- Optional high-flow (1" taller) filter and pre-filter/rain sock also available
- Made in the U.S.A.

NOTE: Exempt per CARB EXECUTIVE ORDER (E.O) No. D-355-16.



SUG. RETAIL **\$149.95** PART # 1010-2009



1011-2306



PL-1500



PL-1598



HIGH-FLOW OEM REPLACEMENT AIR FILTERS

- Designed to increase horsepower and torque
- Pleated design provides increased air-flow and high filtration
- Original K&N High-Flow Technology
- Application specific sealing bead ensures an air-tight fit
- Epoxy-coated aluminum backfire screen protects filter element
- Made in the U.S.A. for over 45 years

FITS MODEL	PART #	SUG. RETAIL	FITS MODEL	PART #	SUG. RETAIL
VICTORY			VICTORY (CONT)		
Boardwalk 13-14	1011-2306	\$73.95	Kingpin 06-07	PL-1500	\$73.95
Gunner 15-16	1011-2306	73.95	Kingpin 08-12	1011-2306	73.95
Hammer 05-07	PL-1500	73.95	V92C 98-99	PL-1598	84.95
Hammer 08-16 (all)	1011-2306	73.95	V92C 00-01	PL-1500	73.95
Highball 11-16	1011-2306	73.95	Vegas 03-07	PL-1500	73.95
Jackpot 14	1011-2306	73.95	Vegas 08-16	1011-2306	73.95
Judge 13-15	1011-2306	73.95			

DISCLAIMER: NOT LEGAL FOR SALE OR USE IN CALIFORNIA ON ANY POLLUTION CONTROLLED MOTOR VEHICLES. SEE PAGE 3 FOR IMPORTANT EMISSION DEFINITIONS AND REGULATORY COMPLIANCE AND WARRANTY INFORMATION.

All part numbers in **BOLD MAGENTA** are new this year.



PARTS & ACCESSORIES FOR INDIAN MOTORCYCLES

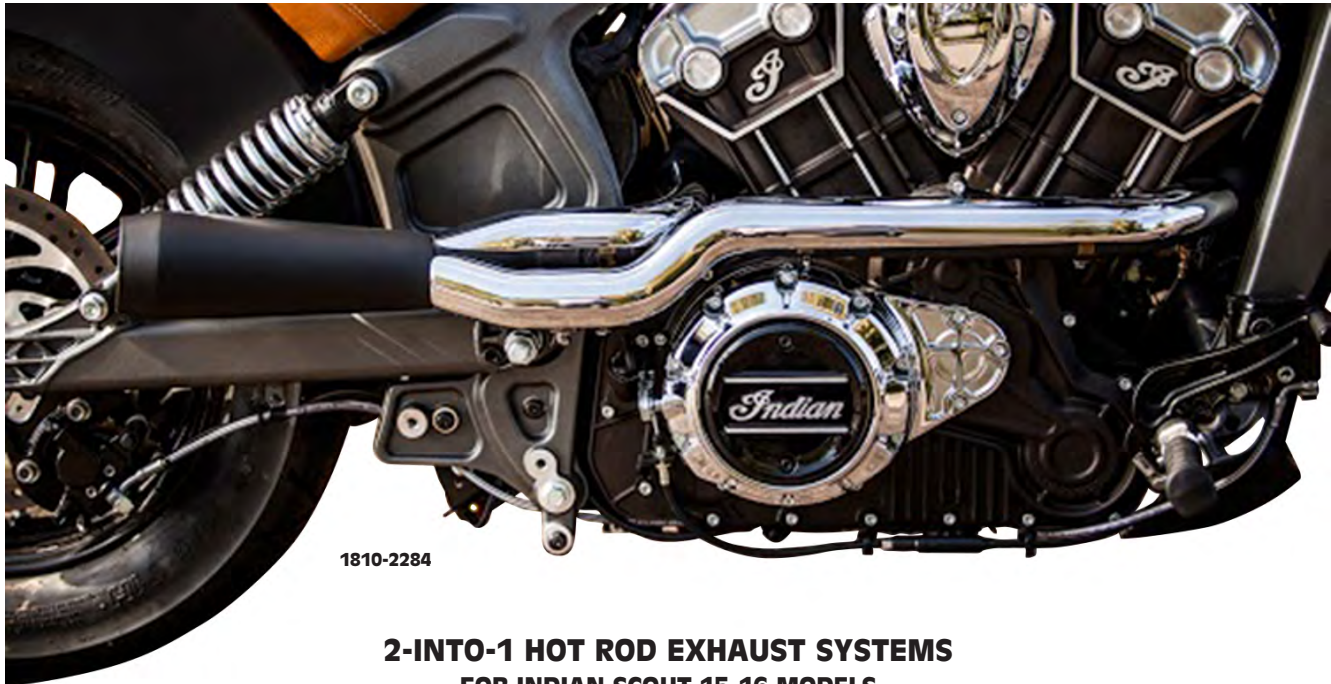

1810-2284

2-INTO-1 HOT ROD EXHAUST SYSTEMS FOR INDIAN SCOUT 15-16 MODELS

- Made from high-quality seamless, mandrel-bent stainless steel
- Dyno developed and tested
- Offer a sleek look, aggressive sound and all-around performance throughout the entire powerband
- Feature full heat-shield coverage and built-in O₂ bungs
- Available in high-quality chrome or black ceramic coated finish
- Made in the U.S.A.

SUG. RETAIL **\$799.95**

DESCRIPTION	PART #	DESCRIPTION	PART #	DESCRIPTION	PART #
Black	1810-2282	Chrome	1810-2283	Black/chrome	1810-2284

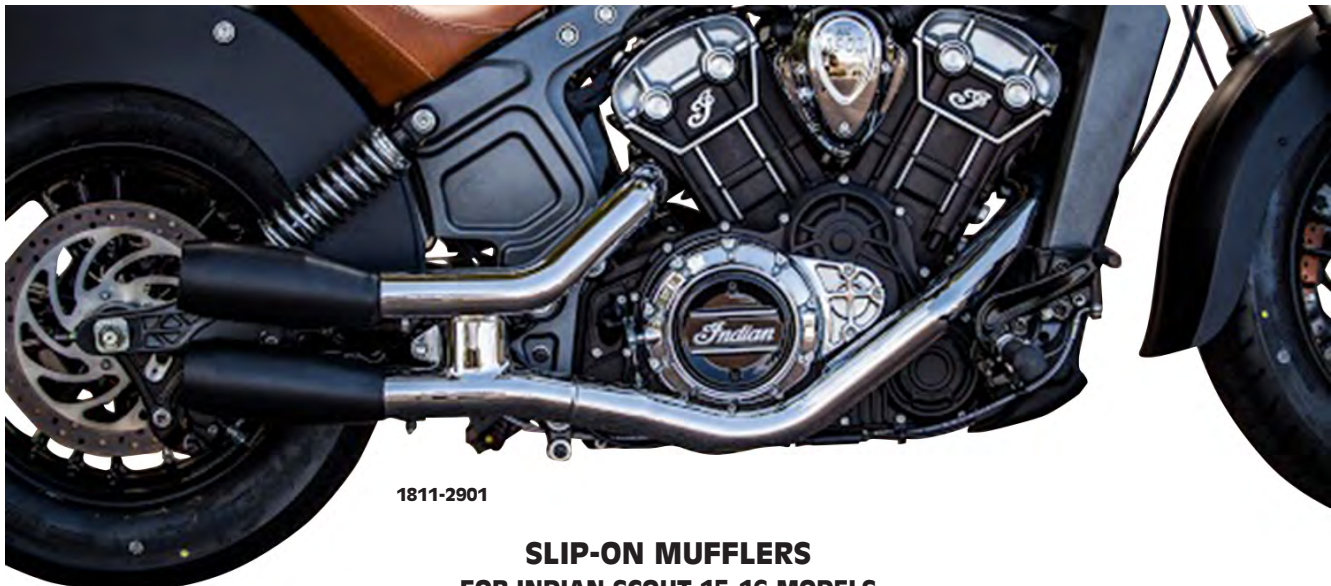

1811-2901

SLIP-ON MUFFLERS FOR INDIAN SCOUT 15-16 MODELS

- Provide improved performance and sound throughout the entire powerband
- Dyno developed and tested
- Made from high-quality steel pipe
- Tapered tip
- Available in high-quality chrome or black ceramic coated finish
- Sold in pairs

SUG. RETAIL **\$599.95**

DESCRIPTION	PART #	DESCRIPTION	PART #
Black	1811-2901	Chrome	1811-2902

DISCLAIMER: NOT LEGAL FOR SALE OR USE IN CALIFORNIA ON ANY POLLUTION CONTROLLED MOTOR VEHICLES.
SEE PAGE 3 FOR IMPORTANT EMISSION DEFINITIONS AND REGULATORY COMPLIANCE AND WARRANTY INFORMATION.

All part numbers in **BOLD MAGENTA** are new this year.

VICTORY

EXHAUST

LUGGAGE

SECURITY

WINDSHIELDS

FAIRINGS & BODY

SEATS & Sissy BARS

HANDLEBARS & HAND CONTROLS

FOOTPEGS & FOOT CONTROLS

LIGHTING

ELECTRICAL

WHEELS & ACCESSORIES

BRAKES & SUSPENSION

ENGINE

FUEL/AIR SYSTEMS

INDIAN

EXHAUST

WINDSHIELDS

FAIRINGS & BODY

SEATS & Sissy BARS

HANDLEBARS & HAND CONTROLS

FOOTPEGS & FOOT CONTROLS

LIGHTING

ELECTRICAL

WHEELS & BRAKES

SUSPENSION

ENGINE

FUEL/AIR SYSTEMS

VICTORY

EXHAUST

LUGGAGE

SECURITY

WINDSHIELD

FAIRINGS & BODY

SEATS & SISSY BARS

HANDLEBARS & HAND CONTROLS

FOOTPEGS & FOOT CONTROLS

LIGHTING

ELECTRICAL

WHEELS & ACCESSORIES

BRAKES & SUSPENSION

ENGINE

FUEL/AIR SYSTEMS

INDIAN

EXHAUST

WINDSHIELDS

FAIRINGS & BODY

SEATS & SISSY BARS

HANDLEBARS & HAND CONTROLS

FOOTPEGS & FOOT CONTROLS

LIGHTING

ELECTRICAL

WHEELS & BRAKES

SUSPENSION

ENGINE

FUEL/AIR SYSTEMS



1810-2352



1810-2355

ROAD RAGE 2-INTO-1 EXHAUST SYSTEMS FOR INDIAN SCOUT 15-16

- Uses 2-into-1 equal-length 1³/₄" to 1⁷/₈" header pipes
- Advanced inner collector maximizes performance gains
- Includes heat shields and all necessary installation hardware
- Available with long or short megaphone-style muffler
- Show chrome or black ceramic finish available
- Made in the U.S.A.

DESCRIPTION	PART #	SUG. RETAIL	DESCRIPTION	PART #	SUG. RETAIL
WITH SHORT MEGAPHONE MUFFLER			WITH LONG MEGAPHONE MUFFLER		
Chrome	1810-2352	\$799.95	Chrome	1810-2354	\$799.95
Black ceramic	1810-2353	859.95	Black ceramic	1810-2355	859.95



1811-2689



4" PERFORMANCE SLIP-ON MUFFLERS FOR INDIAN

- Chromed 4" slip-on mufflers mount to stock headpipes and fit under hard bags
- Gives your bike a unique style, performance and sound
- Comes with a 4" slash-cut polished end cap
- Constructed from 16-gauge stainless steel with a chrome finish
- Optional 4" end caps available separately
- Necessary hardware included
- Made in the U.S.A.



Slash

FITS MODEL	PART #	SUG. RETAIL
INDIAN		
Chieftain 14-16 w/ hard bags, Roadmaster 14-16	1811-2689	\$699.95
Chief Vintage 14-16, Chief Classic 14-16, Chieftain 14-16 w/o bags or w/ soft bags, Darkhorse 14-16	1811-2690	649.95

DESCRIPTION	PART #	SUG. RETAIL	DESCRIPTION	PART #	SUG. RETAIL
OPTIONAL QUICK-CHANGE END CAPS			OPTIONAL QUICK-CHANGE END CAPS (CONT)		
Polish, slash	1861-0748 ¹	\$139.95	Black, fluted +2	1861-1000	\$69.95
Black, slash	1861-0749 ¹	139.95	Black, slash +1	1861-1001	69.95
Black, fluted +1	1861-0999	69.95	Black, slash +2	1861-1002	69.95

¹ Can be rotated to change direction of slash.

DISCLAIMER: NOT LEGAL FOR SALE OR USE IN CALIFORNIA ON ANY POLLUTION CONTROLLED MOTOR VEHICLES. SEE PAGE 3 FOR IMPORTANT EMISSION DEFINITIONS AND REGULATORY COMPLIANCE AND WARRANTY INFORMATION.



1811-2905



1811-2906

**CLASSIC 3" SLIP-ON MUFFLERS WITH TIP
FOR INDIAN SCOUT 15-16**

- 16-gauge steel construction with chrome or black finish
- Includes mounting hardware
- Includes chrome or black billet end cap
- 50% lighter than stock mufflers
- Increases power and performance
- Made in the U.S.A.

SUG. RETAIL **\$499.95**

DESCRIPTION	PART #	DESCRIPTION	PART #
Chrome	1811-2905	Black	1811-2906



**2 1/4" CHROME MUFFLERS WITH BAFFLE AND FISHTAIL END CAPS
FOR INDIAN SCOUT 15-16**

- 16-gauge steel construction with chrome finish and fishtail tips
- Includes mounting hardware
- Baffles are not removable
- Made in the U.S.A.

SUG. RETAIL **\$499.95** PART # 1811-2907

DISCLAIMER: NOT LEGAL FOR SALE OR USE IN CALIFORNIA ON ANY POLLUTION CONTROLLED MOTOR VEHICLES.
SEE PAGE 3 FOR IMPORTANT EMISSION DEFINITIONS AND REGULATORY COMPLIANCE AND WARRANTY INFORMATION.

All part numbers in **BOLD MAGENTA** are new this year.

VICTORY

EXHAUST

LUGGAGE

SECURITY

WINDSHIELDS

FAIRINGS & BODY

SEATS & SISSY BARS

HANDLEBARS & HAND CONTROLS

FOOTPEGS & FOOT CONTROLS

LIGHTING

ELECTRICAL

WHEELS & ACCESSORIES

BRAKES & SUSPENSION

ENGINE

FUEL/AIR SYSTEMS

INDIAN

EXHAUST

WINDSHIELDS

FAIRINGS & BODY

SEATS & SISSY BARS

HANDLEBARS & HAND CONTROLS

FOOTPEGS & FOOT CONTROLS

LIGHTING

ELECTRICAL

WHEELS & BRAKES

SUSPENSION

ENGINE

FUEL/AIR SYSTEMS

VANCE HINES

VICTORY

EXHAUST

LUGGAGE

SECURITY

WINDSHIELDS

FAIRINGS
& BODY

SEATS
& Sissy BARS

HANDLEBARS
& HAND CONTROLS

FOOTPEGS
& FOOT CONTROLS

LIGHTING

ELECTRICAL

WHEELS &
ACCESSORIES

BRAKES &
SUSPENSION

ENGINE

FUEL/AIR
SYSTEMS

INDIAN

EXHAUST

WINDSHIELDS

FAIRINGS
& BODY

SEATS
& Sissy BARS

HANDLEBARS &
HAND CONTROLS

FOOTPEGS &
FOOT CONTROLS

LIGHTING

ELECTRICAL

WHEELS &
BRAKES

SUSPENSION

ENGINE

FUEL/AIR
SYSTEMS



1800-1916



1800-1917

HI-OUTPUT GRENADES 2-INTO-2 EXHAUST SYSTEMS FOR INDIAN SCOUT 15-16



1861-1077

- Features an innovative three-step muffler shape with CNC-machined billet end caps
- Discreet crossover section maintains the aggressive 2-into-2 look
- Aggressive, pulse-quickening exhaust note
- Optional quiet baffle sold separately
- Made in the U.S.A.

DESCRIPTION	PART #	SUG. RETAIL	DESCRIPTION	PART #	SUG. RETAIL	DESCRIPTION	PART #	SUG. RETAIL
Chrome	1800-1916	\$899.99	Matte black	1800-1917	\$899.99	Opt. quiet baffle (ea.)	1861-1077	\$24.95

TWIN SLASH 4" ROUND SLIP-ON MUFFLERS FOR INDIAN SCOUT 15-16



1801-0857

- Give your bike a clean, classic look and an aggressive exhaust note
- Feature 45° slash-cut ends
- Brilliant chrome finish
- Optional quiet baffle sold separately
- Sold in pairs
- Made in the U.S.A.



1861-1075

DESCRIPTION	PART #	SUG. RETAIL	DESCRIPTION	PART #	SUG. RETAIL
Slip-on mufflers	1801-0857	\$499.95	Opt. quiet baffle (ea.)	1861-1075	\$59.99

DISCLAIMER: NOT LEGAL FOR SALE OR USE IN CALIFORNIA ON ANY POLLUTION CONTROLLED MOTOR VEHICLES.
SEE PAGE 3 FOR IMPORTANT EMISSION DEFINITIONS AND REGULATORY COMPLIANCE AND WARRANTY INFORMATION.

VANCE HINES



4" TURN DOWN SLIP-ON MUFFLERS

- Gorgeous nostalgic styling
- Deep rich tone
- 2.5" fiberglass wrapped perforated core baffle
- Beautiful chrome finish with scalloped end caps
- Sold in pairs
- Made in the U.S.A.

SUG. RETAIL **\$749.99**

FITS MODEL	PART #	FITS MODEL	PART #
INDIAN		INDIAN (CONT)	
Chieftain/Roadmaster 14-15	1801-0728	Chief Vintage/Classic/Dark Horse 14-15	1801-0734



4" CLASSIC SLIP-ON MUFFLERS

- Large 4" diameter mufflers finished with beautifully embellished CNC-machined billet end caps add that extra touch of style
- Fiberglass insulated acoustic baffles provide a deep rich rumble to the powerful Thunder Stroke 111 engine
- Include all necessary hardware and mounting instructions for a hassle-free, perfect fit every time
- Optional quiet baffle sold separately
- Sold in pairs
- Made in the U.S.A.



1861-1076

FITS MODEL	FINISH	PART #	SUG. RETAIL	FITS MODEL	FINISH	PART #	SUG. RETAIL
INDIAN				INDIAN (CONT)			
Chief Vintage/Classic/Dark Horse 14-15	Chrome	1801-0828	\$749.99	Chief Vintage/Classic/Dark Horse 14-16	Black	1801-0903	\$749.99
Chieftain/Roadmaster 14-15	Chrome	1801-0829	749.99	Opt. quiet baffle (ea.)	-	1861-1076	99.99

DISCLAIMER: NOT LEGAL FOR SALE OR USE IN CALIFORNIA ON ANY POLLUTION CONTROLLED MOTOR VEHICLES. SEE PAGE 3 FOR IMPORTANT EMISSION DEFINITIONS AND REGULATORY COMPLIANCE AND WARRANTY INFORMATION.

All part numbers in **BOLD MAGENTA** are new this year.

partsnetweb.com / dragnetweb.com

- VICTORY
- EXHAUST
- LUGGAGE
- SECURITY
- WINDSHIELDS
- FAIRINGS & BODY
- SEATS & Sissy BARS
- HANDLEBARS & HAND CONTROLS
- FOOTPEGS & FOOT CONTROLS
- LIGHTING
- ELECTRICAL
- WHEELS & ACCESSORIES
- BRAKES & SUSPENSION
- ENGINE
- FUEL/AIR SYSTEMS
- INDIAN**
- EXHAUST**
- WINDSHIELDS
- FAIRINGS & BODY
- SEATS & Sissy BARS
- HANDLEBARS & HAND CONTROLS
- FOOTPEGS & FOOT CONTROLS
- LIGHTING
- ELECTRICAL
- WHEELS & BRAKES
- SUSPENSION
- ENGINE
- FUEL/AIR SYSTEMS

VICTORY

EXHAUST

LUGGAGE

SECURITY

WINDSHIELDS

FAIRINGS & BODY

SEATS & SISSY BARS

HANDLEBARS & HAND CONTROLS

FOOTPEGS & FOOT CONTROLS

LIGHTING

ELECTRICAL

WHEELS & ACCESSORIES

BRAKES & SUSPENSION

ENGINE

FUEL/AIR SYSTEMS

INDIAN

EXHAUST

WINDSHIELDS

FAIRINGS & BODY

SEATS & SISSY BARS

HANDLEBARS & HAND CONTROLS

FOOTPEGS & FOOT CONTROLS

LIGHTING

ELECTRICAL

WHEELS & BRAKES

SUSPENSION

ENGINE

FUEL/AIR SYSTEMS



1811-2698



KHROME WERKS

4" HP-PLUS® PERFORMANCE SLANT DOWN MUFFLERS

- Cat-back mufflers provide a deep, mellow exhaust tone
- Horsepower and torque gains over stock mufflers are achieved in part by an internal expansion chamber in the baffle core
- The steel baffle core is machine wrapped first with stainless steel wool, then with a high-temperature fiberglass blanket for acoustic longevity assurance
- Designed to enhance top end power while retaining good low end torque
- The one-piece, 16-gauge steel tubing muffler shell is finished in highly polished, duplex nickel chrome
- Install using factory mounting hardware, clamps and heat shields
- Sold in pairs
- Made in the U.S.A.



1811-2699

FITS MODEL	PART #	SUG. RETAIL	FITS MODEL	PART #	SUG. RETAIL
INDIAN			INDIAN (CONT)		
Chief 14-16	1811-2698	\$649.95	Chieftain 14-16	1811-2699	\$669.95

CRUSHER

CRUSHER MAVERICK SLIP-ONS FOR INDIAN SCOUT 15-16

- Shed pounds and gain a 5-percent increase in horsepower without intake or header upgrades
- Slim 2.5" muffler diameter flaunts the Scout's smooth lines and matches the stock headers to preserve the lean profile of traditional staggered dual exhausts
- Aggressively-styled billet aluminum tips with high-temp black ceramic coating and brushed stainless steel banding with the Crusher emblem
- Premium, chrome-plated steel
- High-flow baffles produce a throaty exhaust note when cracking the throttle
- 5% horsepower gain without intake, header or fuel mapping modifications
- Simple, bolt-on installation with included bracket and hardware
- Approximately 14 lb. lighter than stock mufflers
- Made in the U.S.A.



SUG. RETAIL **\$479.99** PART # **1811-3024**

COBRA

4" SLIP-ON MUFFLERS FOR INDIAN CHIEF/CHIEFTAIN/ROADMASTER 14-16

- 4" muffler body
- 2.5" perforated core, with 2" steps
- Proprietary Cobra pillow insulation
- 4" billet aluminum scalloped tip

SUG. RETAIL **\$689.95** PART # **1811-2851**



DISCLAIMER: NOT LEGAL FOR SALE OR USE IN CALIFORNIA ON ANY POLLUTION CONTROLLED MOTOR VEHICLES. SEE PAGE 3 FOR IMPORTANT EMISSION DEFINITIONS AND REGULATORY COMPLIANCE AND WARRANTY INFORMATION.



RIO GRANDE

- The most coverage of any windshield in the Sportshield family
- Made of Lucite® for excellent optics and durability
- Available in four gradient colors and solar (a light tint with 72% visible light transmission)
- Measures approximately 21" W x 19" H above headlight
- Fits most round headlights
- Optional Lower available for additional windshield coverage; see page 23
- No-Tool detachable Trigger-Lock mounting hardware must be ordered separately, available in polished or "Night Shades" black, see page 21
- Made in the U.S.A.

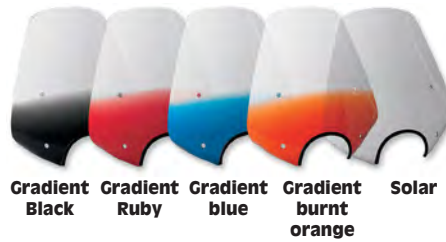

DESCRIPTION	PART #	SUG. RETAIL	DESCRIPTION	PART #	SUG. RETAIL
Gradient black	MEP5311	\$96.95	Gradient blue	MEP5316	\$96.95
Gradient ruby	MEP5312	96.95	Gradient burnt orange	2311-0003	95.95



DESCRIPTION	PART #	SUG. RETAIL
Solar	MEP5319	\$96.95

EL PASO

- Headlight cutout sized for 5³/₄ - 7" headlight
- Smooth design complements the lines of your machine
- Tapered windshield lower is ideal for handlebar-mounted turn signals
- Made of Lucite® for excellent optics and durability
- Available in gradient black and solar (a light tint with 72% visible light transmission)
- Measures approximately 20" W; available in 17" or 19" H above headlight
- Fits most round headlights
- Optional Lower available for additional windshield coverage; see page 23
- No-Tool detachable Trigger-Lock mounting hardware must be ordered separately; available in polished or "Night Shades" black, see page 21
- Made in the U.S.A.

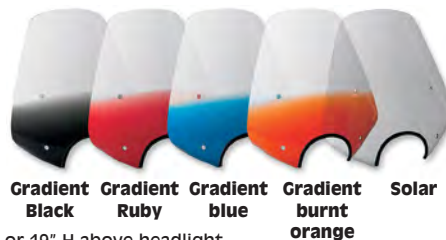

DESCRIPTION	PART #	SUG. RETAIL	DESCRIPTION	PART #	SUG. RETAIL
17" TALL			19" TALL		
Gradient black	MEP5211	\$96.95	Gradient black	MEP5221	\$96.95
Gradient ruby	MEP5212	96.95	Gradient ruby	MEP5222	96.95
Gradient blue	MEP5216	96.95	Gradient blue	MEP5226	96.95
Gradient burnt orange	2311-0004	95.95	Gradient burnt orange	2311-0005	95.95
Solar	MEP5219	96.95	Solar	MEP5229	96.95



DEL RIO

- Good torso protection in a sleek windshield design
- Made of Lucite® for excellent optics and durability
- Available in seven gradient colors and solar (a light tint with 72% visible light transmission)
- Measures approximately 19" W x 15" H above headlight
- Fits most round headlights
- Optional Lower available for additional windshield coverage; see page 23
- No-Tool detachable Trigger-Lock mounting hardware must be ordered separately; available in polished or "Night Shades" black, see page 21
- Made in the U.S.A.

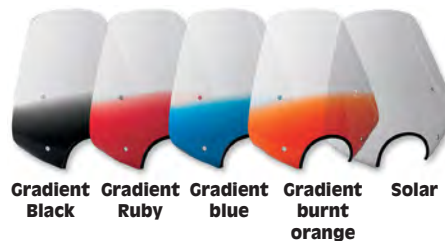

DESCRIPTION	PART #	SUG. RETAIL	DESCRIPTION	PART #	SUG. RETAIL
Gradient black	MEP5111	\$86.95	Gradient blue	MEP5116	\$86.95
Gradient ruby	MEP5112	86.95	Gradient burnt orange	2311-0002	86.95



DESCRIPTION	PART #	SUG. RETAIL
Solar	MEP5119	\$86.95

DEL REY

- Small, sleek design that offers good protection in a minimalist package
- Made of Lucite® for excellent optics and durability
- Available in seven gradient colors and solar (a light tint with 72% visible light transmission)
- Measures approximately 15" W x 13" H above headlight
- Fits most round headlights
- Optional Lower available for additional windshield coverage; see page 23
- No-Tool detachable Trigger-Lock mounting hardware must be ordered separately; available in polished or "Night Shades" black, see page 21
- Made in the U.S.A.

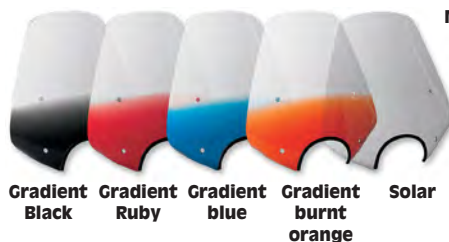

DESCRIPTION	PART #	SUG. RETAIL	DESCRIPTION	PART #	SUG. RETAIL
Gradient black	MEP5011	\$75.95	Gradient burnt orange	2311-0001	\$75.95
Gradient ruby	MEP5012	75.95	Solar	MEP5019	75.95
Gradient blue	MEP5016	75.95			



All part numbers in **BOLD MAGENTA** are new this year.



VICTORY

EXHAUST

LUGGAGE

SECURITY

WINDSHIELDS

FAIRINGS & BODY

SEATS & Sissy BARS

HANDLEBARS & HAND CONTROLS

FOOTPEGS & FOOT CONTROLS

LIGHTING

ELECTRICAL

WHEELS & ACCESSORIES

BRAKES & SUSPENSION

ENGINE

FUEL/AIR SYSTEMS

INDIAN

EXHAUST

WINDSHIELDS

FAIRINGS & BODY

SEATS & Sissy BARS

HANDLEBARS & HAND CONTROLS

FOOTPEGS & FOOT CONTROLS

LIGHTING

ELECTRICAL

WHEELS & BRAKES

SUSPENSION

ENGINE

FUEL/AIR SYSTEMS



QUICK-CHANGE MOUNT KITS FOR FATS/SLIM AND SPORTSHIELDS

- Memphis Shades Fats/Slim hardware kits feature Quick-Change mounting, which allows you to remove or swap out your Memphis Fats or Slim windshields in about one minute
- Hardware is custom-fit to each style of bike for no-hassle installation
- Hardware includes stainless steel bolts and CNC-machined aluminum mounting plates and anchors
- For additional coverage, Memphis Shades Lower (page 23) and custom mounting kits (below) are also available



PLATE-ONLY HARDWARE KITS

- Allow changing from Fats/Slim to Sportshield or from Sportshield to Fats/Slim without purchasing the entire mounting hardware

QUICK-CHANGE MOUNT KITS

PLATE-ONLY HARDWARE KITS

SUG. RETAIL **\$149.95**

SUG. RETAIL **\$65.95**

FATS/SLIM QUICK-CHANGE MOUNT KITS

FITS MODEL	FATS/SLIM QUICK-CHANGE MOUNT KITS POLISHED	FATS/SLIM QUICK-CHANGE MOUNT KITS BLACK	PLATE-ONLY KITS POLISHED	PLATE-ONLY KITS BLACK
Scout 15-16	2321-0370	2321-0372	2321-0371	2321-0373
Scout Sixty 16	2321-0370	2321-0372	2321-0371	2321-0373

¹ Must use windshield with 9" headlight cutout.

QUICK-CHANGE KITS SPORTSHIELD MOUNTING KITS

FITS MODEL	SPORTSHIELD QUICK-CHANGE MOUNT KITS POLISHED	SPORTSHIELD QUICK-CHANGE MOUNT KITS BLACK	PLATE-ONLY KITS POLISHED	PLATE-ONLY KITS BLACK
Scout 15-16	2321-0366	2321-0368	2321-0367	2321-0369
Scout Sixty 16	2321-0366	2321-0368	2321-0367	2321-0369

¹ Must use windshield with 9" headlight cutout.

TURN SIGNAL RELOCATION KIT BLACK

DESCRIPTION	PART#	SUG. RETAIL
Scout 15-16	2321-0374	\$19.95
Scout Sixty 16	2321-0374	19.95



2312-0261



2312-0262



2312-0263

FLARE™ WINDSHIELDS

FOR INDIAN CHIEFTAIN 14-17/ROADMASTER 15-17



- Installs easily using stock mounting hardware
- Maintains stock windshield height adjustability
- Looks great and performs even better
- Innovative design features "hips" at the outer edge of the shield that re-routes the air to add downforce and aid stability
- "Flip" at the top sends clean, less turbulent air to rider and passenger
- Manufactured from dual-side hard-coated polycarbonate material for outstanding impact strength
- Available in Tall and Short heights
- Choose from tint, dark smoke, and black color options
- Made in the U.S.A.

SUG. RETAIL **\$209.95**

COLOR	HEIGHT	PART #	COLOR	HEIGHT	PART #
TALL			SHORT		
Tint	12"	2312-0259	Tint	10"	2312-0261
Dark smoke	12"	2312-0260	Dark smoke	10"	2312-0262
			Black	10"	2312-0263



ARLEN NESS FAIRING

FOR INDIAN SCOUT 15-16, SCOUT SIXTY 16

- Sturdy ABS plastic construction
- Included Plexiglass windscreen has a smoke tint
- Available with a gloss black finish or raw (unpainted) finish that is ready for prep and paint
- All necessary mounting hardware included
- Requires relocation of front turn signals for installation
- Made in the U.S.A.



2331-0121

DESCRIPTION	PART #	SUG. RETAIL	DESCRIPTION	PART #	SUG. RETAIL
Gloss black	2331-0121	\$379.95	Raw	2331-0122	\$329.95



ACCUTRONIX SIDE-MOUNT LICENSE PLATES FOR INDIAN SCOUT

- Billet 6061-T6 construction
- Includes a bright LED license plate light
- Mounts horizontally or vertically
- Mounts on the left side of the swingarm in place of the oval axle adjuster plate
- Window size: 6" x 3 1/4"
- Outside dimensions: 7 1/2" x 4 1/2"
- Mounting holes: 5 3/4" x 2 3/4"
- Available in chrome and black finishes
- Made in the U.S.A.



2030-0905



2030-0906

SUG. RETAIL\$179.95

DESCRIPTION	PART #	DESCRIPTION	PART #
Black	2030-0905	Chrome	2030-0906



KURYAKYN LED CURVED LICENSE PLATE FRAME WITH MOUNT FOR ALL MODELS 14-16 (EXCEPT SCOUT)

- Die-cast aluminum frame is a direct replacement that hugs the rear fender and complements surrounding OEM chrome accents
- Built-in LEDs illuminate the license plate



SUG. RETAIL\$119.99 PART # 2030-0974



MUSTANG FENDER BIBS FOR INDIAN CHIEF 14-16, CHIEF DARK HORSE 16, CHIEF VINTAGE 14-16, CHIEFTAIN 14-16

- Adds style to your ride
- Made with waterproof black synthetic leather that will look good for years to come
- Felt-backed to protect your bike's paint
- Uses stock mounts and fits snug to edge of fender without any gaps
- Made in the U.S.A.



1405-0197



1405-0198

STYLE	PART #	SUG. RETAIL	STYLE	PART #	SUG. RETAIL
Studded	1405-0197	\$39.00	Vintage	1405-0198	\$34.00

All part numbers in **BOLD MAGENTA** are new this year.

- VICTORY
- EXHAUST
- LUGGAGE
- SECURITY
- WINDSHIELDS
- FAIRINGS & BODY
- SEATS & SISSY BARS
- HANDLEBARS & HAND CONTROLS
- FOOTPEGS & FOOT CONTROLS
- LIGHTING
- ELECTRICAL
- WHEELS & ACCESSORIES
- BRAKES & SUSPENSION
- ENGINE
- FUEL/AIR SYSTEMS
- INDIAN
- EXHAUST
- WINDSHIELDS
- FAIRINGS & BODY
- SEATS & SISSY BARS
- HANDLEBARS & HAND CONTROLS
- FOOTPEGS & FOOT CONTROLS
- LIGHTING
- ELECTRICAL
- WHEELS & BRAKES
- SUSPENSION
- ENGINE
- FUEL/AIR SYSTEMS

VICTORY

EXHAUST

LUGGAGE

SECURITY

WINDSHIELDS

FAIRINGS & BODY

SEATS & SISSY BARS

HANDLEBARS & HAND CONTROLS

FOOTPEGS & FOOT CONTROLS

LIGHTING

ELECTRICAL

WHEELS & ACCESSORIES

BRAKES & SUSPENSION

ENGINE

FUEL/AIR SYSTEMS

INDIAN

EXHAUST

WINDSHIELDS

FAIRINGS & BODY

SEATS & SISSY BARS

HANDLEBARS & HAND CONTROLS

FOOTPEGS & FOOT CONTROLS

LIGHTING

ELECTRICAL

WHEELS & BRAKES

SUSPENSION

ENGINE

FUEL/AIR SYSTEMS



1402-0364

1402-0362



1402-0363

FRONT FENDERS FOR INDIAN SCOUT 15

- All fenders come predrilled and E-coated and are stamped, not spun, for the ultimate smooth long-lasting fender
- Steel fenders are thick enough to add rigidity to the front end by acting like a fork brace but can still be cut or shaped enough for an even more Kustom appearance
- 16", 17" and 18" fenders for Indian Scout models
- Benchmark is a more slammed, lower profile look
- Klassic is a timeless style, representing the design lines of the Scouts of the 20's and 30's
- Outrider is a tire hugging style
- All are direct bolt-on replacement front fenders that use stock mounting hardware
- Made in the U.S.A.

SUG. RETAIL\$279.95

16"/17"/18"/19" FRONT WHEEL					
DESCRIPTION	PART #	DESCRIPTION	PART #	DESCRIPTION	PART #
Benchmark	1402-0364	Klassic	1402-0362	Outrider	1402-0363



OUTRIDER REAR FENDER FOR INDIAN SCOUT 15-16

- Direct bolt-on replacement fender offers an instant bobber style, using stock mounting locations and hardware
- Complete with bolt-in taillight/license plate mount (included)
- Stamped from 14 gauge steel using precision deep-draw stamping technology that ensures a consistently smooth and flawless finish that minimizes bodywork
- E-coated to prevent rust and corrosion from manufacture to paint booth, and beyond as it continues to resist rust after paint
- Precision laser cut technology ensures accurate fitment
- Works with stock 150/80-16 rear and up to a 180 rear tire
- Made in the U.S.A.

SUG. RETAIL\$479.95

PART # 1402-0365



NUMBER PLATE KIT FOR INDIAN SCOUT 15-17, SCOUT 60 16-17

- Personalize, identify, and get that hot competition look for an Indian Scout with aluminum number plates
- Easy to install because they are pre-drilled to use the stock rear fender mounting locations
- Precision cut from heavy gauge aluminum
- The hardware is even included
- Sold in pairs
- Made in the U.S.A.



SUG. RETAIL\$99.95 PART # 1405-0218



OUTRIDER RAD GUARD FOR INDIAN SCOUT 15-16

- Guards the radiator against road debris
- Easy-to-install laser cut honeycomb aluminum mesh screen
- Includes installation instructions and mounting adhesive
- Made in the U.S.A.

SUG. RETAIL\$74.95

PART # 1904-0092

KURYAKYN 



WINDSHIELD TRIM

FOR INDIAN CHIEFTAIN, ROADMASTER 14-16

- Classes up the top edge of the fairing
- Chrome ABS construction
- Easy to install

SUG. RETAIL\$79.99 **PART #** 2350-0276

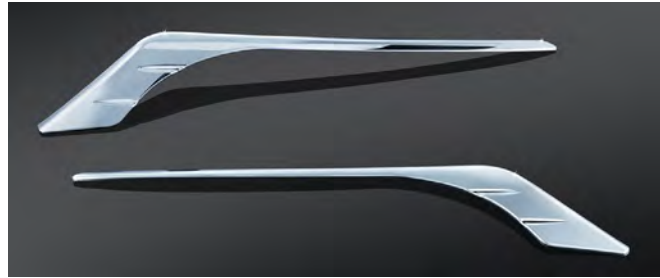

FRONT FAIRING TURN SIGNAL TRIM

FOR INDIAN CHIEFTAIN/ROADMASTER 14-16

- Continue the design lines from the OEM chrome fairing panel to the front turn signals
- Quick, simple peel-and-stick installation
- Sold in pairs

SUG. RETAIL\$59.99 **PART #** 0521-1254

TOP DASH ACCENT

FOR CHIEFTAIN/ROADMASTER 14-16

- Injection-molded chrome-plated ABS accent complements OEM gauge bezels
- Design incorporates the same raised center and grooved scallop feature found above the OEM headlight housing
- Simple, peel-and-stick application

SUG. RETAIL\$59.99



PART # 2202-0222



SPEAKER GRILLES

FOR INDIAN CHIEFTAIN/ROADMASTER 14-16

- Add just the right amount of chrome to the inner fairing
- Easy to install

SUG. RETAIL\$89.99

PART # 4405-0374



CHROME OIL COOLER COVER

FOR ALL INDIAN 14-16 MODELS (EXCEPT SCOUT 15-16)

- Mounts directly over the oil cooler
- Does not restrict airflow
- Simple to install

SUG. RETAIL\$59.99



PART # 0713-0130

VICTORY

EXHAUST

LUGGAGE

SECURITY

WINDSHIELDS

FAIRINGS & BODY

SEATS & SISSY BARS

HANDLEBARS & HAND CONTROLS

FOOTPEGS & FOOT CONTROLS

LIGHTING

ELECTRICAL

WHEELS & ACCESSORIES

BRAKES & SUSPENSION

ENGINE

FUEL/AIR SYSTEMS

INDIAN

EXHAUST

WINDSHIELDS

FAIRINGS & BODY

SEATS & SISSY BARS

HANDLEBARS & HAND CONTROLS

FOOTPEGS & FOOT CONTROLS

LIGHTING

ELECTRICAL

WHEELS & BRAKES

SUSPENSION

ENGINE

FUEL/AIR SYSTEMS

All part numbers in **BOLD MAGENTA** are new this year.

VICTORY

EXHAUST

LUGGAGE

SECURITY

WINDSHIELDS

FAIRINGS & BODY

SEATS & Sissy BARS

HANDLEBARS & HAND CONTROLS

FOOTPEGS & FOOT CONTROLS

LIGHTING

ELECTRICAL

WHEELS & ACCESSORIES

BRAKES & SUSPENSION

ENGINE

FUEL/AIR SYSTEMS

INDIAN

EXHAUST

WINDSHIELDS

FAIRINGS & BODY

SEATS & Sissy BARS

HANDLEBARS & HAND CONTROLS

FOOTPEGS & FOOT CONTROLS

LIGHTING

ELECTRICAL

WHEELS & BRAKES

SUSPENSION

ENGINE

FUEL/AIR SYSTEMS



KURYAKYN

STARTER COVER FOR INDIAN 14-16 (ALL EXCEPT SCOUT)

- Chrome-plated die-cast aluminum construction
- Simple bolt-on installation
- All necessary hardware included

SUG. RETAIL \$69.99

PART # 2110-0582



KURYAKYN

TAILLIGHT TOP TRIM FOR INDIAN CHIEF CLASSIC/VINTAGE, CHIEFTAIN, ROADMASTER 14-16

- Matches the stock chrome around the lower part of taillight
- Peel-and-stick installation

SUG. RETAIL \$29.99

PART # 2010-1232



HIDDEN TRAILER HITCH FOR 14-16 ALL INDIAN MODELS EXCEPT SCOUT

- Hitch is hidden when tongue is removed
- Bolt on installation
- Made from high-tensile steel
- Chrome plated tongue
- Includes mounting instructions and hardware
- Made in the U.S.A.

SUG. RETAIL \$299.95

PART # 3902-0190



LAYDOWN LICENSE PLATE AND DOUBLE FLAG HOLDER FOR INDIAN CHIEF, CHIEFTAIN, ROADMASTER 14-16

- Designed for a custom "laydown" look; replaces plastic OEM part
- Made of high-quality stainless steel that is hand polished to a brilliant finish
- Flag poles are topped with chrome finials and include clips to keep flags in place at pole tops
- Mounts easily and will remain sturdy, even at highway speeds
- Accommodates 6" x 9" flags (not included)
- Made in the U.S.A.

SUG. RETAIL \$79.95

PART #

2030-1017



0521-1469



0521-1470



0521-1471



FLAG MOUNTS WITH USA FLAG

- Extends flag pole app. 1.25" from rack
- High quality stainless steel
- Includes allen keys for easy installation
- Made in the U.S.A.

DESCRIPTION	PART #	SUG. RETAIL
FITS .51" HORIZONTAL ROUND BAR		
9" Pole, 6" x 9" Flag	0521-1469	\$59.95
13" Pole, 10" x 15" Flag	0521-1472	74.95

DESCRIPTION	PART #	SUG. RETAIL
FITS .765" HORIZONTAL ROUND BAR		
9" Pole, 6" x 9" Flag	0521-1470	\$59.95
13" Pole, 10" x 15" Flag	0521-1473	74.95

DESCRIPTION	PART #	SUG. RETAIL
FITS .765" VERTICAL ROUND BAR FOR CHIEF CLASSIC AND CHIEF VINTAGE QUICK RELEASE (PASSENGER Sissy BAR)		
9" Pole, 6" x 9" Flag	0521-1471	\$59.95
13" Pole, 10" x 15" Flag	0521-1474	74.95



DELUXE SOLO RACK BAG

- Constructed of heavy-duty, water-resistant polyester
- Expandable, contoured bag fits most solo racks and sissy bar racks
- Expandable side pockets for extra carrying capacity
- 1617 cu. in. of lined storage space
- Quick-release side lock buckle anchoring system with belly strap
- Rain cover and shoulder strap included
- Expanded dimensions: 14" L x 16 1/2" W x 7" H

SUG. RETAIL\$99.95

PART # 3515-0170



VICTORY

EXHAUST

LUGGAGE

SECURITY

WINDSHIELDS

FAIRINGS & BODY

SEATS & SISSY BARS

HANDLEBARS & HAND CONTROLS

FOOTPEGS & FOOT CONTROLS

LIGHTING

ELECTRICAL

WHEELS & ACCESSORIES

BRAKES & SUSPENSION

ENGINE

FUEL/AIR SYSTEMS

INDIAN

EXHAUST

WINDSHIELDS

FAIRINGS & BODY

SEATS & SISSY BARS

HANDLEBARS & HAND CONTROLS

FOOTPEGS & FOOT CONTROLS

LIGHTING

ELECTRICAL

WHEELS & BRAKES

SUSPENSION

ENGINE

FUEL/AIR SYSTEMS



HIDE A KEY POUCH

- Made from weather-resistant, marine-grade vinyl
- Hides an extra key on your bike to keep it clean and ready to use should the need arise
- 6" hook-and-loop strap provides a secure fit that will not give way, even under the harshest conditions
- Measures 3 1/2" L x 2 1/4" W to fit even the largest keys
- Available in black
- Made in the U.S.A.

SUG. RETAIL\$8.95

PART #

3550-0273



KURYAKYN

PASSENGER DRINK HOLDER FOR CHIEFTAIN 14-16, ROADMASTER 15-16 WITH TOUR TRUNK

- Mount to the right side of the factory Tour Trunk
- Quick-detach design leaves only a small satin black bracket visible when holder is removed
- Mesh basket has rubber "fingers" that grip to hold a variety of cup or bottle shapes/sizes securely in place

SUG. RETAIL\$69.99 **PART # 0603-0739**

All part numbers in **BOLD MAGENTA** are new this year.



KURYAKYN

SADDLEBAG TOP TRIM FOR INDIAN CHIEFTAIN/ROADMASTER/ SPRINGFIELD 14-16

- Four-piece accent set (two pieces per saddlebag)
- Accentuate classic curves on hard saddlebags
- Chrome-plated ABS with easy, peel-and-stick installation

SUG. RETAIL\$79.99 **PART # 3501-1125**



VICTORY

EXHAUST

LUGGAGE

SECURITY

WINDSHIELDS

FAIRINGS & BODY

SEATS & SISSY BARS

HANDLEBARS & HAND CONTROLS

FOOTPEGS & FOOT CONTROLS

LIGHTING

ELECTRICAL

WHEELS & ACCESSORIES

BRAKES & SUSPENSION

ENGINE

FUEL/AIR SYSTEMS

INDIAN

EXHAUST

WINDSHIELDS

FAIRINGS & BODY

SEATS & SISSY BARS

HANDLEBARS & HAND CONTROLS

FOOTPEGS & FOOT CONTROLS

LIGHTING

ELECTRICAL

WHEELS & BRAKES

SUSPENSION

ENGINE

FUEL/AIR SYSTEMS



0810-1828



0810-1826



0810-1827

VINTAGE SOLO SEATS WITH DRIVER BACKREST FOR INDIAN SCOUT 15-16

- Provides quality comfort and design
- Features a precisely molded proprietary foam that contours to the shapes and angles needed for optimal cruising comfort
- 13" W solo seat provides ample room for comfort without compromising the look of the bike
- Constructed of marine-grade fiberglass for a secure install and long-term durability
- Features a fully adjustable driver backrest and a clean vintage look
- Available in brown or black vinyl, with or without leather inserts and nickel-plated studs
- Made in the U.S.A.



0810-1825

DESCRIPTION	PART #	SUG. RETAIL	DESCRIPTION	PART #	SUG. RETAIL	DESCRIPTION	PART #	SUG. RETAIL	DESCRIPTION	PART #	SUG. RETAIL
STUDDED			STUDDED W/ LEATHER INSERTS			VINTAGE			VINTAGE W/ LEATHER INSERTS		
Black	0810-1828	\$519.00	Black	0810-1830	\$539.00	Black	0810-1827	\$509.00	Black	0810-1829	\$529.00
Brown	0810-1824	519.00	Brown	0810-1826	539.00	Brown	0810-1823	509.00	Brown	0810-1825	529.00



0810-1836



0810-1834



0810-1835



0810-1845

VINTAGE SOLO SEATS FOR INDIAN SCOUT 15-16

- Provides quality comfort and vintage design
- Features a precisely molded proprietary foam that contours to the shapes and angles needed for optimal cruising comfort
- 13" W driver and 8.5" W passenger solo seat provides ample room for comfort without compromising the look of the bike
- Constructed of marine-grade fiberglass for a secure install and long-term durability
- Available in brown or black vinyl, with or without leather inserts and nickel-plated studs
- Made in the U.S.A.



0810-1833



0810-1843

DESCRIPTION	PART #	SUG. RETAIL	DESCRIPTION	PART #	SUG. RETAIL	DESCRIPTION	PART #	SUG. RETAIL	DESCRIPTION	PART #	SUG. RETAIL
STUDDED			STUDDED W/ LEATHER INSERTS			VINTAGE			VINTAGE W/ LEATHER INSERTS		
Driver, black	0810-1836	\$319.00	Driver, black	0810-1838	\$339.00	Driver, black	0810-1835	\$309.00	Driver, black	0810-1837	\$329.00
Driver, brown	0810-1832	319.00	Driver, brown	0810-1834	339.00	Driver, brown	0810-1831	309.00	Driver, brown	0810-1833	329.00
Passenger, black	0810-1846	199.00	Passenger, black	0810-1848	199.00	Passenger, black	0810-1845	189.00	Passenger, black	0810-1847	189.00
Passenger, brown	0810-1842	199.00	Passenger, brown	0810-1844	199.00	Passenger, brown	0810-1841	189.00	Passenger, brown	0810-1843	189.00

SOLO TOURING SEATS AND PASSENGER SEATS



- Seat positions the rider 1.5" back from stock
- Driver and passenger seats use controlled-density foam for ample support and all-day riding comfort
- Premium-quality expanded vinyl cover
- Studded style features a studded skirt with conchos and braid that extends below the edge of the seat
- Vintage style has no conchos or studs for a clean look
- Driver's seats available with or without built-in backrest
- Passenger seats available with or without receiver for optional backrest (sold separately)
- Made in the U.S.A.



SOLO TOURING SEATS

FITS MODEL	SEAT WIDTH	STYLE	PART #	SUG. RETAIL
INDIAN				
Chief 14-16, Chief Dark	16.5"	Studded	0810-1631	\$342.00
Horse 16, Chief Vintage	16.5"	Studded w/ backrest	0810-1632	\$46.00
14-16, Chieftain 14-16	16.5"	Vintage	0810-1633	\$321.00
	16.5"	Vintage w/ backrest	0810-1634	\$25.00

PASSENGER SEATS

FITS MODEL	SEAT WIDTH	STYLE	PART #	SUG. RETAIL
INDIAN				
Chief 14-16, Chief	13"	Studded	0810-1635	\$219.00
Dark Horse 16,	13"	Studded w/ backrest receiver	0810-1636	\$260.00
Chief Vintage 14-16,	13"	Vintage	0810-1638	\$209.00
Chieftain 14-16	13"	Vintage w/ backrest receiver	0810-1637	\$250.00

PASSENGER BACKRESTS

DESCRIPTION	PART #	SUG. RETAIL	DESCRIPTION	PART #	SUG. RETAIL
Vintage	0822-0218	\$204.00	Studded	0822-0221	\$214.00

RUNAROUND™ SOLO SEATS

FOR INDIAN SCOUT 15-16, SCOUT SIXTY 16



- Provides quality comfort and distinctive styling
- Features a precisely molded proprietary foam that contours to the shapes and angles needed for optimal cruising comfort
- Engineered low, this 9.5" W solo seat provides a cool and classy look
- Constructed of marine-grade fiberglass for a secure install and long-term durability
- Available in brown or black vinyl
- Made in the U.S.A.



NOTE: Not intended for use with a passenger seat. SUG. RETAIL \$264.00

DESCRIPTION	PART #	DESCRIPTION	PART #
Black	0810-1839	Brown	0810-1840

SOLO SEATS FOR INDIAN SCOUT 15-16



- Seats are designed to fit seamlessly with the stock rear fender
- Extra padding for maximum comfort during the ride
- Ergonomic shape keeps the rider seated firmly and comfortably
- Marine-grade fiberglass base plate
- Controlled-density polyurethane foam
- RSD metal logo
- Boss seat features triple-stitched, hand-sewn lines and a raised, perforated diamond pattern and black distressed vinyl material
- Enzo seat is a rich brown with a high level of detail
- Bolt-on installation
- Made in the U.S.A.



DESCRIPTION	PART #	SUG. RETAIL	DESCRIPTION	PART #	SUG. RETAIL
Boss	0802-0880	\$399.95	Enzo	0802-0881	\$419.95

2-UP SEATS FOR INDIAN SCOUT 15-16



- Carefully designed to flow with rather than disrupt the lines of the motorcycle
- Ergonomic shape keeps the rider seated firmly and comfortably
- Marine-grade fiberglass base plate
- Controlled-density polyurethane foam
- RSD metal logo
- Boss seat features triple-stitched, hand-sewn lines and a raised, perforated diamond pattern and black distressed vinyl material
- Enzo seat is a rich brown with a high level of detail
- Bolt-on installation
- Made in the U.S.A.



DESCRIPTION	PART #	SUG. RETAIL	DESCRIPTION	PART #	SUG. RETAIL
Boss	0802-0882	\$439.95	Enzo	0802-0883	\$459.95

All part numbers in **BOLD MAGENTA** are new this year.

- VICTORY
- EXHAUST
- LUGGAGE
- SECURITY
- WINDSHIELDS
- FAIRINGS & BODY
- SEATS & SISSY BARS
- HANDLEBARS & HAND CONTROLS
- FOOTPEGS & FOOT CONTROLS
- LIGHTING
- ELECTRICAL
- WHEELS & ACCESSORIES
- BRAKES & SUSPENSION
- ENGINE
- FUEL/AIR SYSTEMS
- INDIAN**
- EXHAUST
- WINDSHIELDS
- FAIRINGS & BODY
- SEATS & SISSY BARS**
- HANDLEBARS & HAND CONTROLS
- FOOTPEGS & FOOT CONTROLS
- LIGHTING
- ELECTRICAL
- WHEELS & BRAKES
- SUSPENSION
- ENGINE
- FUEL/AIR SYSTEMS

SEATS & SISSY BARS

VICTORY

EXHAUST

LUGGAGE

SECURITY

WINDSHIELDS

FAIRINGS & BODY

SEATS & SISSY BARS

HANDLEBARS & HAND CONTROLS

FOOTPEGS & FOOT CONTROLS

LIGHTING

ELECTRICAL

WHEELS & ACCESSORIES

BRAKES & SUSPENSION

ENGINE

FUEL/AIR SYSTEMS

INDIAN

EXHAUST

WINDSHIELDS

FAIRINGS & BODY

SEATS & SISSY BARS

HANDLEBARS & HAND CONTROLS

FOOTPEGS & FOOT CONTROLS

LIGHTING

ELECTRICAL

WHEELS & BRAKES

SUSPENSION

ENGINE

FUEL/AIR SYSTEMS



0810-1871



0810-1872



SEAT PAN KITS

FOR INDIAN SCOUT 15-17, SCOUT 60 16-17

- Great seat pan options for the Indian Scout
- Outrider seat pan kit comes with a smaller, sportier, black leather seat
- Klassic comes with a more traditional, larger, brown seat
- Kits include everything needed to convert
- Metal pan and all brackets are black powder-coated
- Made in the U.S.A.



DESCRIPTION	PART #	SUG. RETAIL	DESCRIPTION	PART #	SUG. RETAIL
Klassic	0810-1871	\$324.95	Outrider	0810-1872	\$274.95

KURYAKYN

SADDLE SHIELDS

FOR INDIAN 14-16 MODELS (EXCEPT SCOUT)

- Beat the heat produced by the potent Thunder Stroke™ 111 powerplant
- Redirects heat from motor and headpipes away from rider to increase comfort
- A classic high-temp reflective smoke finish provides a refined, aesthetically pleasing appearance
- Made from durable polycarbonate
- Bolts directly to the rear tank mount using existing hardware
- Sold in pairs



SUG. RETAIL\$79.99 PART # 0504-0284



VINTAGE SISSY BAR PADS

- Provides quality comfort and vintage design
- Mounts directly to stock scout bar
- 9" tall x 7.5" wide
- Available in brown or black vinyl, with or without nickel-plated studs
- Made in the U.S.A.



0822-0256



0822-0253

DESCRIPTION	PART #	SUG. RETAIL	DESCRIPTION	PART #	SUG. RETAIL
STUDED			VINTAGE		
Black	0822-0256	\$91.00	Black	0822-0255	\$81.00
Brown	0822-0254	91.00	Brown	0822-0253	81.00

SISSY BAR PADS

FOR INDIAN CHIEF 14-16, CHIEF DARK HORSE 16, CHIEF VINTAGE 14-16, CHIEFTAIN 14-16

- Fits OEM sissy bar
- Premium-quality expanded vinyl cover
- Foam is contoured to follow natural curvature of the back
- Available in Vintage or Studded styles to match Mustang seats
- Measures 12" W x 9" H
- Sold each
- Made in the U.S.A.



0822-0219

DESCRIPTION	PART #	SUG. RETAIL	DESCRIPTION	PART #	SUG. RETAIL
Studded	0822-0219	\$111.00	Vintage	0822-0220	\$101.00

VICTORY

EXHAUST

LUGGAGE

SECURITY

WINDSHIELDS

FAIRINGS & BODY

SEATS & Sissy BARS

HANDLEBARS & HAND CONTROLS

FOOTPEGS & FOOT CONTROLS

LIGHTING

ELECTRICAL

WHEELS & ACCESSORIES

BRAKES & SUSPENSION

ENGINE

FUEL/AIR SYSTEMS

INDIAN

EXHAUST

WINDSHIELDS

FAIRINGS & BODY

SEATS & Sissy BARS

HANDLEBARS & HAND CONTROLS

FOOTPEGS & FOOT CONTROLS

LIGHTING

ELECTRICAL

WHEELS & BRAKES

SUSPENSION

ENGINE

FUEL/AIR SYSTEMS



Chrome/Chrome



Black/Chrome



Black/Black

KLIP HANGER HANDLEBAR KITS



- The ultimate in rider personal adjustment and fit
- Innovative "Klamps" allow the control/grip portions of the handlebar to be adjusted in several directions to allow the rider to find that perfect fit
- Included handlebars manufactured from DOM tubing, clamps machined from 6061 billet aluminum, chrome hardware, polished aluminum domed bar end plugs
- Bars are drilled and slotted for internal wiring and work with heated grips
- Bar ends are slotted for throttle-by-wire option
- Fully knurled center section (riser clamp area) for use with stock riser clamp set-up
- Made in the U.S.A.



0601-3255

DESCRIPTION	PART #	SUG. RETAIL	DESCRIPTION	PART #	SUG. RETAIL	DESCRIPTION	PART #	SUG. RETAIL
FOR INDIAN SCOUT 15-16, AND SCOUT 60 16			FOR INDIAN SCOUT 15-16, AND SCOUT 60 16 (CONT)			FOR INDIAN CHIEFTAIN 14-16/ROADMASTER 15-16 (ALL)		
5" Chrome/chrome	0601-3426	\$459.95	10" Chrome/chrome	0601-3423	\$459.95	12" Chrome/chrome	0601-3254	\$599.95
5" Black/chrome	0601-3427	459.95	10" Black/chrome	0601-3424	459.95	12" Black/chrome	0601-3255	599.95
5" Black/black	0601-3425	459.95	10" Black/black	0601-3422	459.95	12" Black/black	0601-3253	599.95



0601-3130

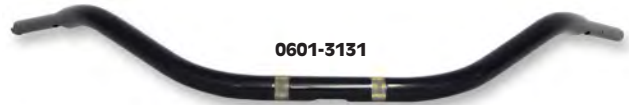

0601-3131



Black cable

PRAIRIE HANDLEBAR FIT KITS FOR INDIAN CHIEF CLASSIC AND CHIEF VINTAGE 15



- Combine traditional beach bar styling with a more comfortable, relaxed cruising position
- Wider and lower than the stock bars on your Indian Chief Classic or Vintage, with 3" more pullback for reduced reach to the handgrips and controls
- Easy to replace your stock bars by including necessary cables in the convenient Prairie Bar Fit Kit
- Available in chrome or black, cables are black in both kits
- Made in the U.S.A.

SUG. RETAIL**\$374.95**

DESCRIPTION	END RISE	WIDTH	CENTER WIDTH	PULLBACK	DIAMETER	PART #
Chrome	8"	37"	8"	14"	1.25"	0601-3130
Black	8"	37"	8"	14"	1.25"	0601-3131



0601-3592



0601-3592

KLASIC HANDLEBARS FOR INDIAN SCOUT 15-17, SCOUT 60 16-17



- A great choice for building a bobber, and/or just a vintage feel
- Low-profile bars give a more forward stance, and traditional flat track style
- More aggressive position than stock bars, and they position rider's wrists/arms outward when compared to stock
- Made in the U.S.A.

SUG. RETAIL**\$279.95**

DESCRIPTION	END RISE	WIDTH	CENTER WIDTH	PULLBACK	PART #
Chrome	3"	35"	8"	8"	0601-3593
Black	3"	35"	8"	8"	0601-3592

All part numbers in **BOLD MAGENTA** are new this year.

HANDLEBARS & HAND CONTROLS

VICTORY

EXHAUST

LUGGAGE

SECURITY

WINDSHIELDS

FAIRINGS & BODY

SEATS & Sissy BARS

HANDLEBARS & HAND CONTROLS

FOOTPEGS & FOOT CONTROLS

LIGHTING

ELECTRICAL

WHEELS & ACCESSORIES

BRAKES & SUSPENSION

ENGINE

FUEL/AIR SYSTEMS

INDIAN

EXHAUST

WINDSHIELDS

FAIRINGS & BODY

SEATS & Sissy BARS

HANDLEBARS & HAND CONTROLS

FOOTPEGS & FOOT CONTROLS

LIGHTING

ELECTRICAL

WHEELS & BRAKES

SUSPENSION

ENGINE

FUEL/AIR SYSTEMS



0601-3056



0601-3057

1 1/4" V-LINE HANDLEBARS

- Seamless DOM mild steel construction with black powder-coat or chrome finish
- All bars have a 1" grip area, are drilled for internal wiring and notched for TBW
- The 2+ bars offer 2" more rise than the standard V-line bar
- Made in the U.S.A.

NOTE: Will require the use of narrow control clamp halves, PART #s 0615-0273 or 0615-0274.

DESCRIPTION	PART #	DESCRIPTION	PART #
Black powder-coat	0601-3056	Chrome	0601-3057

SUG. RETAIL **\$309.95**



TRASK



TRASK

V-LINE GRIPS FOR INDIAN

- Contoured and feature rubber inserts for maximum comfort and superior grip
- Available in chrome or gloss black powder-coat finish w/ reverse cut
- Made in the U.S.A.

SUG. RETAIL **\$159.95**

DESCRIPTION	PART #	DESCRIPTION	PART #
Reverse Cut	0630-1602	Chrome	0630-1603



0630-1839

KURYAKYN



0630-1840

SPEAR GRIPS

- Grip housings are cast aluminum with a chrome-plated finish
- Embedded soft EPDM rubber inserts provide sure grip in all conditions, reduce vibration and allow airflow
- Sold in pairs

SUG. RETAIL **\$89.99**

FITS MODEL	PART #
INDIAN	
Chief/Chieftain/Dark Horse/Springfield 14-16	0630-1839
Scout 15-16	0630-1840



GLOSS BLACK KINETIC GRIPS FOR INDIAN SCOUT 15-16

- Designed to keep moving forward with the latest in styling and vibration-isolating technology
- Aluminum body and EPDM rubber to help ride with less fatigue and more control in a modern design
- Sold in pairs

SUG. RETAIL **\$89.99**

PART #	PART #
0630-1823	0630-1823

ISO®-GRIPS FOR ALL INDIAN MODELS 14-16 (EXCEPT SCOUT/ROADMASTER MODELS WITH OEM HEATED GRIPS)

- Combine style and comfort in a soft, nonslip surface that dampens handlebar vibrations
- Recessed area between ISO®-Pads allows cooling airflow in warm weather
- Knurled accent ring adds a touch of class
- Sold in pairs

NOTE: Not compatible with bar-end weights.

SUG. RETAIL **\$79.99** PART # 0630-1464





0630-1502



0630-1504



0630-1497



0630-1505



0630-1506



0630-1501

AIR CUSHIONED GRIPS

FOR INDIAN 14-17 MODELS WITH 1" HANDLEBARS (ALL EXCEPT SCOUT)



- Feature billet end caps and rings with ergonomic AVON seamless rubber grip technology
- Designed with a very soft, tacky and durable material
- Fit 1" handlebars
- Available in chrome or black anodized design with or without throttle boss
- Made in the U.S.A.

DESCRIPTION	PART #	SUG. RETAIL	DESCRIPTION	PART #	SUG. RETAIL
3-ring, chrome	0630-1496	\$59.95	Excalibur, chrome	0630-1499	\$89.95
3-ring, black-anodized	0630-1502	59.95	Excalibur, black-anodized	0630-1505	89.95
Spike, chrome	0630-1498	69.95	Gatin, chrome	0630-1500	94.95
Spike, black-anodized	0630-1504	69.95	Gatin, black-anodized	0630-1506	94.95
3-ring, chrome w/ throttle boss	0630-1497	79.95	Rival, chrome	0630-1501	89.95
3-ring, black-anodized w/ throttle boss	0630-1503	79.95	Rival, black-anodized	0630-1507	89.95



CUSTOM SPIKE END GRIPS

FOR INDIAN 14-17 MODELS WITH 1" HANDLEBARS (ALL EXCEPT SCOUT)

- Feature an ergonomic AVON seamless rubber grip technology
- Billet aluminum end caps and collars
- Available in chrome or black anodized
- Made in the U.S.A.



0630-1508



0630-1509

DESCRIPTION	PART #	SUG. RETAIL	DESCRIPTION	PART #	SUG. RETAIL
Chrome	0630-1508	\$69.95	Black-anodized	0630-1509	



0630-1510



0630-1511

GEL GRIPS
FOR INDIAN 14-17 MODELS WITH 1" HANDLEBARS (ALL EXCEPT SCOUT)

- Ergonomic grip
- Soft, GEL rubber
- Tacky, rubber feel
- Vibration dampening
- Billet aluminum ends
- Made in the U.S.A.

SUG. RETAIL\$59.95

DESCRIPTION	PART #	DESCRIPTION	PART #
Chrome	0630-1510	Black anodized	0630-1511



0630-1845



CROSS STYLE GRIPS
FOR INDIAN 14-17 MODELS WITH 1" HANDLEBARS

- Ergonomic seamless rubber grip technology
- Billet aluminum end caps and collars
- Available in black anodize with off-set cut or chrome
- Made in the U.S.A.

SUG. RETAIL\$88.95

COLOR	PART #	COLOR	PART #
Black	0630-1845	Chrome	0630-1846



KURYAKYN
RAISED MIRROR ADAPTERS

FOR ALL INDIAN MODELS 14-16

- Provide a raised mirror mount location essential for mounting Kuryakyn mirrors
- Raise mirror mounting position approximately 1 1/2"
- Allow clearance from brake master cylinder and greatly improve visibility
- Quality stainless steel with a polished finish for a stunning appearance
- Sold in pairs

SUG. RETAIL\$17.99

PART #	SUG. RETAIL
0641-0178	\$17.99

VICTORY

EXHAUST

LUGGAGE

SECURITY

WINDSHIELDS

FAIRINGS & BODY

SEATS & Sissy BARS

HANDLEBARS & HAND CONTROLS

FOOTPEGS & FOOT CONTROLS

LIGHTING

ELECTRICAL

WHEELS & ACCESSORIES

BRAKES & SUSPENSION

ENGINE

FUEL/AIR SYSTEMS

INDIAN

EXHAUST

WINDSHIELDS

FAIRINGS & BODY

SEATS & Sissy BARS

HANDLEBARS & HAND CONTROLS

FOOTPEGS & FOOT CONTROLS

LIGHTING

ELECTRICAL

WHEELS & BRAKES

SUSPENSION

ENGINE

FUEL/AIR SYSTEMS

All part numbers in **BOLD MAGENTA** are new this year.

HANDLEBARS & HAND CONTROLS

VICTORY

EXHAUST

LUGGAGE

SECURITY

WINDSHIELDS

FAIRINGS & BODY

SEATS & Sissy BARS

HANDLEBARS & HAND CONTROLS

FOOTPEGS & FOOT CONTROLS

LIGHTING

ELECTRICAL

WHEELS & ACCESSORIES

BRAKES & SUSPENSION

ENGINE

FUEL/AIR SYSTEMS

INDIAN

EXHAUST

WINDSHIELDS

FAIRINGS & BODY

SEATS & Sissy BARS

HANDLEBARS & HAND CONTROLS

FOOTPEGS & FOOT CONTROLS

LIGHTING

ELECTRICAL

WHEELS & BRAKES

SUSPENSION

ENGINE

FUEL/AIR SYSTEMS



Magnetic iOcore



0636-0045



0636-0049



0636-0050



0636-0055

iOmounts™ DEVICE MOUNTS FOR INDIAN VINTAGE, DARKHORSE, CLASSIC, CHIEFTAIN, ROADMASTER W/ STOCK CONTROLS 14-16



- Motorcycle model-specific mounts incorporate the iOmounts™ system; install the mount to bike with included hardware
 - Nomad Universal mount fits any handlebars that are .5" to 2" in diameter; includes Nomad, two iOadapts and two iOskins
 - Attach razor-thin iOadapt stainless steel adapter to your device and connect to the powerful iOcore magnetic carrier
 - Device is held in place by the strong iOcore magnet, and you can adjust the angle of your device
 - iOskin provides perfect surface to mount iOadapt, and protects device from iOadapt adhesive
- NOTE: Not for use with Samsung Galaxy S4 phones.**

DESCRIPTION	PART #	SUC. RETAIL
OPTIONAL MAGNETIC IOCORE		
Green iOcore	0636-0037	\$19.95
Black iOcore	0636-0038	19.95
Blue iOcore	0636-0039	19.95
Gray iOcore	0636-0040	19.95

DESCRIPTION	PART #	SUC. RETAIL
OPTIONAL MAGNETIC IOCORE (CONT)		
Orange iOcore	0636-0041	\$19.95
Pink iOcore	0636-0042	19.95
Red iOcore	0636-0043	19.95
Yellow iOcore	0636-0044	19.95

DESCRIPTION	PART #	SUC. RETAIL
REPLACEMENT COMPONENTS (EA.)		
iOskin	0636-0046	\$4.95
iOadapt disc	0636-0045	9.95

COLOR	PART #	SUC. RETAIL
MODEL-SPECIFIC PERCH MOUNTS		
Chrome	0636-0049	\$99.95

COLOR	PART #	SUC. RETAIL
MODEL-SPECIFIC PERCH MOUNTS (CONT)		
Black	0636-0050	\$99.95

COLOR	PART #	SUC. RETAIL
UNIVERSAL MOUNTS		
Nomad	0636-0055	\$59.95

BRAIDED HIGH EFFICIENCY CLUTCH CABLES



- The Industry's highest-quality braid available in two color choices to complement your bike; Sterling Chromite II® and Black Pearl braided with black wire
- Braid color and weave match on all Magnum control cables and brake lines
- Coated with a non-yellowing, crystal-clear outer jacket for exceptional protection against scuffing paint or chrome
- All fittings are polished and chrome or black-chrome plated
- Low effort, high-efficiency cable design
- All cables are factory lubricated for smooth, consistent, long lasting-operation
- Made in the U.S.A.



STERLING CHROMITE II

FITS MODEL	OEM #	STOCK	+2"	+4"	+6"	+8"
INDIAN						
Chief, Chieftain, Springfield 14-16	7082130	0652-2036	0652-2045	0652-2046	0652-2047	0652-2048
Scout, Scout Sixty 15-16	7082099	0652-2037	0652-2049	0652-2050	0652-2051	-

BLACK PEARL

FITS MODEL	OEM #	STOCK	+2"	+4"	+6"	+8"
INDIAN						
Chief, Chieftain, Springfield 14-16	7082130	0652-2039	0652-2056	0652-2057	0652-2058	0652-2059
Scout, Scout Sixty 15-16	7082099	0652-2040	0652-2060	0652-2061	0652-2062	-

PART #	SUC. RETAIL	PART #	SUC. RETAIL	PART #	SUC. RETAIL	PART #	SUC. RETAIL	PART #	SUC. RETAIL	PART #	SUC. RETAIL
0652-2036	\$104.95	0652-2040	\$85.95	0652-2047	\$104.95	0652-2050	\$85.95	0652-2057	\$104.95	0652-2060	\$85.95
0652-2037	85.95	0652-2045	104.95	0652-2048	104.95	0652-2051	85.95	0652-2058	104.95	0652-2061	85.95
0652-2039	104.95	0652-2046	104.95	0652-2049	85.95	0652-2056	104.95	0652-2059	104.95	0652-2062	85.95

STAINLESS STEEL CABLES



- Barnett cables are smooth-working, long-lasting and made with the finest components available, making them virtually indestructible
- Stainless steel cables with clear coating offer that custom look without the fear of damaging areas that the cables come in contact with
- Available with standard nylon-lined, PVC-coated casings in standard diameters
- Made in the U.S.A.



FITS MODEL	DESCRIPTION	STAINLESS STEEL PART #	SUC. RETAIL	BLACK VINYL PART #	SUC. RETAIL
INDIAN					
Chief/Chieftain 14-16	Clutch	0652-1971	\$102.95	0652-1969	\$85.95
	Clutch (+6")	0652-1972	102.95	0652-1970	85.95
Scout 14-16	Clutch	0652-1975	78.95	0652-1973	65.95
	Clutch (+6")	0652-1976	102.95	0652-1974	85.95

VICTORY

EXHAUST

LUGGAGE

SECURITY

WINDSHIELDS

FAIRINGS & BODY

SEATS & Sissy BARS

HANDLEBARS & HAND CONTROLS

FOOTPEGS & FOOT CONTROLS

LIGHTING

ELECTRICAL

WHEELS & ACCESSORIES

BRAKES & SUSPENSION

ENGINE

FUEL/AIR SYSTEMS

INDIAN

EXHAUST

WINDSHIELDS

FAIRINGS & BODY

SEATS & Sissy BARS

HANDLEBARS & HAND CONTROLS

FOOTPEGS & FOOT CONTROLS

LIGHTING

ELECTRICAL

WHEELS & BRAKES

SUSPENSION

ENGINE

FUEL/AIR SYSTEMS

103

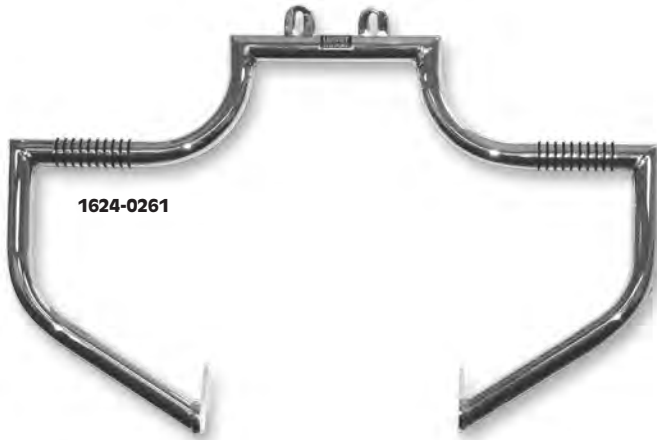

1624-0261

LINDBY CUSTOM, INC. *mobile* THE LINBAR®

LINBAR® FRONT HIGHWAY BARS

- Made from 1 1/4" high-strength steel that has a triple-chrome-plated finish for long-lasting durability
 - Precision bent and welded for a perfect fit every time
 - Neoprene O-rings provide traction in all climates
- U.S. Patent #D361311.

NOTE: Not recommended for use with extended forward controls or extended floorboards.

SUG. RETAIL\$369.95



1907-5010

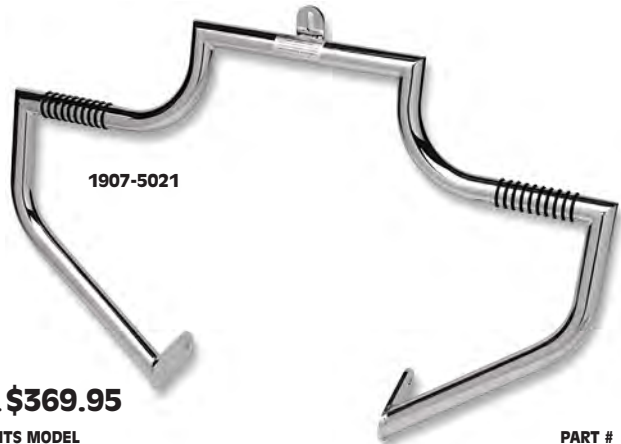

1907-5021

FITS MODEL	PART #
INDIAN	
Chief Classic 14-16, Chief Vintage 14-16	1624-0261
Chief 00-01	1907-5010

FITS MODEL	PART #
INDIAN (CONT)	
Chief 02-03	1907-5021
Spirit 02-03	7805-0030



HIGHWAY BAR RAIN GUARDS WITH ULTRA POCKETS

FOR INDIAN CHIEF/ CHIEFTAIN 14-15

- Designed to help keep rain and road debris off your boots and lower legs
- Produce minimal wind resistance and do not affect airflow to the motor
- Ultra Pockets provide extra storage
- Fit Cobra® Standard Freeway or Fatty bars
- Sold as a set
- Made in the U.S.A.



1624-0281



1624-0313

DESCRIPTION	PART #	SUG. RETAIL
Black	1624-0281	\$130.95

DESCRIPTION	PART #	SUG. RETAIL
Tan	1624-0313	\$160.95



ADJUSTABLE PASSENGER FLOORBOARDS

FOR INDIAN CLASSIC, VINTAGE, CHIEFTAIN 14-15, ROADMASTER 15

- Classic steel passenger floorboards measure 8" x 5" and replace stock fixed passenger pegs and mounts
- Machined from billet aluminum and feature triple chrome plating with soft anti-vibration neoprene rubber pads
- Install easily without modification to the bike
- Adjust in seconds to 12 positions through a 9" range of motion - no tools required
- Provide great passenger comfort
- Sold in pairs
- Made in the U.S.A.

SUG. RETAIL\$429.95

PART #

1621-0744



All part numbers in **BOLD MAGENTA** are new this year.

VICTORY

EXHAUST

LUGGAGE

SECURITY

WINDSHIELDS

FAIRINGS & BODY

SEATS & Sissy BARS

HANDLEBARS & HAND CONTROLS

FOOTPEGS & FOOT CONTROLS

LIGHTING

ELECTRICAL

WHEELS & ACCESSORIES

BRAKES & SUSPENSION

ENGINE

FUEL/AIR SYSTEMS

INDIAN

EXHAUST

WINDSHIELDS

FAIRINGS & BODY

SEATS & Sissy BARS

HANDLEBARS & HAND CONTROLS

FOOTPEGS & FOOT CONTROLS

LIGHTING

ELECTRICAL

WHEELS & BRAKES

SUSPENSION

ENGINE

FUEL/AIR SYSTEMS



CARL BROUHARD DESIGNS LLC.

ELITE DRIVER AND PASSENGER FLOORBOARDS FOR INDIAN CHIEFTAIN/ROADMASTER/CHIEF CLASSIC/CHIEF VINTAGE 14-16

- Driver's boards lower the foot 1" from the stock position
- Oversize floorboards measure 18" L x 5" W; that is 2" longer and .5" wider than the stock boards for a more comfortable riding position
- Passenger boards measure 11" L x 3.5" W
- All boards are made of 6061 billet aluminum and available in chrome or black anodize with off-set cut
- Made in the U.S.A.



DESCRIPTION	PART #	SUG. RETAIL
DRIVER FLOORBOARDS		
Black anodize w/ off-set cut	1621-0642	\$507.95
Chrome	1621-0643	507.95

DESCRIPTION	PART #	SUG. RETAIL
PASSENGER FLOORBOARDS		
Black anodize w/ off-set cut	1621-0706	\$432.95
Chrome	1621-0707	432.95



1610-0460

1610-0461

ELITE BRAKE ARMS FOR INDIAN CHIEFTAIN/ROADMASTER/CHIEF CLASSIC/CHIEF VINTAGE 14-16

- Create a more comfortable foot position
- Coordinate with CBD Elite floorboards and brake pedals for Indian models
- Made of 6061 billet aluminum and available in chrome or black anodize with off-set cut
- Easy to install; mounting hardware included
- Made in the U.S.A.

DESCRIPTION	PART #	DESCRIPTION	PART #
Black anodize w/ off-set cut	1610-0460	Chrome	1610-0461

SUG. RETAIL**\$189.95**



1610-0270

1610-0271

ELITE BRAKE PEDALS FOR INDIAN CHIEFTAIN/ROADMASTER/CHIEF CLASSIC/CHIEF VINTAGE 14-15

- Made of 6061 billet aluminum and available in chrome or black anodize with off-set cut
- Sleek design measures 5.75" L
- Coordinate with CBD Elite floorboards and brake arms for Indian models
- Mount directly to CBD brake arm PART #s 1610-0460 or 1610-0461; will not work with stock brake arm
- Made in the U.S.A.

DESCRIPTION	PART #	DESCRIPTION	PART #
Black anodize w/ off-set cut	1610-0270	Chrome	1610-0271

SUG. RETAIL**\$101.95**



1610-0469

1610-0470

1610-0453

1610-0454

BRAKE PEDALS FOR INDIAN CHIEFTAIN/ROADMASTER/CHIEF CLASSIC/CHIEF VINTAGE 14-16

- Made of 6061 billet aluminum and available in chrome or black anodize with off-set cut
- Coordinate with CBD Elite floorboards and brake arms for Indian models
- Easy to install; mounting hardware included
- Mount directly to CBD brake arm PART #s 1610-0460 or 1610-0461; will not work with stock brake arm
- Made in the U.S.A.

DESCRIPTION	PART #	DESCRIPTION	PART #
Black anodize w/ off-set cut	1610-0469	Chrome	1610-0470

SUG. RETAIL**\$112.95**

BRAKE PEDAL COVERS FOR INDIAN CHIEFTAIN/ROADMASTER/CHIEF CLASSIC/CHIEF VINTAGE 14-16

- Cover the stock brake pedal
- Coordinate with CBD Elite Floorboards for Indian models
- Made of 6061 billet aluminum and available in chrome or black anodize with off-set cut
- Made in the U.S.A.

DESCRIPTION	PART #	DESCRIPTION	PART #
Black anodize w/ off-set cut	1610-0453	Chrome	1610-0454

SUG. RETAIL**\$101.95**



CARL BROUHARD DESIGNS LLC.

ELITE HEEL TOE SHIFTERS FOR INDIAN CHIEFTAIN/ROADMASTER/ CHIEF CLASSIC/CHIEF VINTAGE 14-16

- Replace the stock single shifter
- Made of 6061 billet aluminum and available in chrome or black anodize with off-set cut
- Coordinate with CBD Elite floorboards and brake arms for Indian models
- Mounting hardware included
- Made in the U.S.A.

SUG. RETAIL \$298.95



DESCRIPTION	PART #	DESCRIPTION	PART #
Black anodize w/ off-set cut	1602-1026	Chrome	1602-1027



CARL BROUHARD DESIGNS LLC.

SHIFT ARM

FOR INDIAN CHIEF, CHIEF CLASSIC, CHIEF VINTAGE, ROADMASTER 14-16

- Replaces the stock arm
- Made of 6061 billet aluminum
- Chrome or black off-set cut finish available
- Shift peg sold separately
- Made in the U.S.A.

DESCRIPTION	PART #	DESCRIPTION	PART #
Black w/ off-set cut	1602-1028	Chrome	1602-1029



CARL BROUHARD DESIGNS LLC.

SHIFTER PEGS

- Constructed of 6061 T-6 billet aluminum
- Install using 5/16" -24 stud
- Pyramid rubber for added traction
- Available with chrome or black-anodized finish
- Matches CBD floorboards
- Easy to install
- Made in the U.S.A.

DESCRIPTION	PART #	DESCRIPTION	PART #
Black	1603-0134	Chrome	1603-0135



"INSTIGATOR" EXTENDED FRONT FLOORBOARDS FOR ALL INDIAN 14-16 MODELS (EXCEPT SCOUT)

- Give a custom look
- Floorboards machined from 6061 T-6 billet aluminum
- Boards extended 1" further forward and rear than stock boards; are 1 3/8" wider than stock
- Feature multi-directional non-slip black Pyramid Top rubber inserts
- Chrome or black anodized/raw aluminum finish available
- Install using stock mounts and hardware
- Made in the U.S.A.

DESCRIPTION	PART #	DESCRIPTION	PART #
Chrome	1621-0632	Black anodized/aluminum	1621-0633



precision crafted billet products



REAR FOLDING FOOTPEG ADAPTERS FOR INDIAN CHIEF 14-16, CHIEFTAIN 14-16

- CNC-machined 6061 T-6 billet aluminum with a brilliant chrome or black anodized finish
- 1 1/4" diameter, and attached with the stock footpeg pin and then attached with a 5/16" bolt to the adapters
- Allow the use of standard H-D® male-mount style footpegs to be used on Indian models
- Sold in pairs
- Made in the U.S.A.

SUG. RETAIL \$77.95

DESCRIPTION	PART #
Chrome	1620-1245
Black anodized	1620-1246

VICTORY

EXHAUST

LUGGAGE

SECURITY

WINDSHIELDS

FAIRINGS & BODY

SEATS & Sissy BARS

HANDLEBARS & HAND CONTROLS

FOOTPEGS & FOOT CONTROLS

LIGHTING

ELECTRICAL

WHEELS & ACCESSORIES

BRAKES & SUSPENSION

ENGINE

FUEL/AIR SYSTEMS

INDIAN

EXHAUST

WINDSHIELDS

FAIRINGS & BODY

SEATS & Sissy BARS

HANDLEBARS & HAND CONTROLS

FOOTPEGS & FOOT CONTROLS

LIGHTING

ELECTRICAL

WHEELS & BRAKES

SUSPENSION

ENGINE

FUEL/AIR SYSTEMS

All part numbers in **BOLD MAGENTA** are new this year.

KURYAKYN

VICTORY

EXHAUST

LUGGAGE

SECURITY

WINDSHIELDS

FAIRINGS & BODY

SEATS & Sissy BARS

HANDLEBARS & HAND CONTROLS

FOOTPEGS & FOOT CONTROLS

LIGHTING

ELECTRICAL

WHEELS & ACCESSORIES

BRAKES & SUSPENSION

ENGINE

FUEL/AIR SYSTEMS

INDIAN

EXHAUST

WINDSHIELDS

FAIRINGS & BODY

SEATS & Sissy BARS

HANDLEBARS & HAND CONTROLS

FOOTPEGS & FOOT CONTROLS

LIGHTING

ELECTRICAL

WHEELS & BRAKES

SUSPENSION

ENGINE

FUEL/AIR SYSTEMS



1620-0924



1620-1082

1620-1084

TRIDENT ISO®-PEGS

- An updated design of the original ISO®-Pegs
- Look great with stock or custom footrests
- Footpegs without male-mount ends require the use of Kuryakyn footpeg adapters, see page 107
- All styles sold in pairs

DESCRIPTION	PART #	SUG. RETAIL
CHROME		
Small Trident pegs (4 ⁵ / ₈ " x 1 ¹ / ₄ ") w/o male-mount ends	1620-0923	\$39.99
Large Trident pegs (4 ⁷ / ₈ " x 1 ¹ / ₂ ") w/o male-mount ends	1620-0924	\$39.99
Dually Trident pegs (4 ¹ / ₂ " x 1 ¹ / ₄ ") w/o male-mount ends	1620-0925	\$69.99
GLOSS BLACK		
Small Trident pegs w/o male-mount ends	1620-1082	\$39.99
Large Trident pegs w/o male-mount ends	1620-1083	\$39.99
Dually Trident pegs w/o male-mount ends	1620-1084	\$69.99



ISO®-SWEPTWING PEGS

- Simple, stylish design adds a sleek, streamlined look to your bike
- Feature the traditional ISO® design to reduce vibration and provide long-distance comfort
- Pegs without male-mount ends require Kuryakyn footpeg adapters, see page 107
- Sold in pairs

SUG. RETAIL\$69.99

PART #1620-0370



SWINGWING PEGS

- A convenient alternative to forward controls
- Our clever cruise peg features a fold-forward design
- Secondary fold-out peg extends 3" forward and locks into place for added legroom and comfort
- Pegs without male-mount ends require the use of Kuryakyn splined footpeg adapters, see page 107
- Sold in pairs

SUG. RETAIL\$159.99

PART #1620-0423

FLAMIN' SWITCHBLADE PEGS

- Flip-out heel rest adds comfort
- Heel rests have curb feeler tabs underneath
- Flip-out arm is designed only to be used as a heel rest
- Available without male-mount ends
- Pegs without male-mount ends require male-mount footpeg adapters

SUG. RETAIL\$159.99

PART #1620-1145



WIDOW PEGS

- Full custom footpeg design
- Ominous black widow design nestled in the rubber pads
- Footpegs without male-mount ends require the use of Kuryakyn footpeg adapters, see page 107
- Sold in pairs

SUG. RETAIL\$99.99

PART #1611-0016



TOE-REST CRUISE PEGS FOR INDIAN MODELS WITH 1¹/₄" ENGINE GUARDS

- Minimalist toe rest mounts attach directly to engine guard to allow heel to sit on floorboard with front of foot resting just behind engine guard
- Fit stock 1¹/₄" round engine guards
- Sold in pairs

SUG. RETAIL\$99.99

PART #1624-0309



KURYAKYN



SPEAR SHIFT/BRAKE PEG

- Made from quality die-cast aluminum
- Form-fitted proprietary EPDM premium rubber compound inserts
- Wide, no-slip surface area for excellent foot engagement
- Quick installation
- Can be used as shift and brake peg on all Scout models 15-16
- Can be used as shift peg only on Chief/Chieftain/Roadmaster models 14-16
- Sold each

SUG. RETAIL ... \$39.99

PART # 1603-0306



1602-1044



1602-1045

KINETIC SHIFT AND BRAKE PEG

- Shift through gears or stop on a dime in style
- Direct replacement and includes a 3/8" spacer to adjust the position during installation

SUG. RETAIL \$34.99

DESCRIPTION	PART #
CHIEF CLASSIC/VINTAGE, CHIEFTAIN, ROADMASTER, DARK HORSE 14-16 (SHIFT PEG ONLY) AND SCOUT 15-16 (SHIFT AND BRAKE PEG)	
Chrome	1602-1044
Gloss black	1602-1045



1620-1140



1620-1557



1620-1558



1620-0274

FOOTPEG ADAPTERS

- For use with Kuryakyn footpegs and floorboards that do not have male-mount ends
- Beautiful chrome finish
- Rider and passenger peg adapters available
- If additional mounting hardware is necessary, it is included with adapters
- Sold in pairs

SUG. RETAIL \$26.99

FITS MODEL	FRONT	REAR
INDIAN		
Chief Classic, Chief Vintage, Chieftain 14-16	-	1620-1140
Dark Horse 16	-	1620-1140 ¹
Scout 15-16	1620-1557	1620-1140 ¹

¹ Must use accessory peg mounts from Indian.

SPLINED ADAPTER MOUNTS

- Provide slip-free mounting of Kuryakyn ISO®-Boards™ and other Kuryakyn footpeg and foot control accessories that require splined peg adapter mounts
- Designed for use with the OEM footpeg mount
- Sold in pairs

SUG. RETAIL \$26.99

FITS MODEL	FRONT	REAR
INDIAN		
Chief Classic, Chief Vintage, Chieftain 14-16	-	1620-0724
Dark Horse 16	-	1620-0724 ¹
Scout 15-16	1620-1558	1620-0724 ¹

¹ Must use accessory peg mounts from Indian.



SPLINED PASSENGER BOARD MOUNT ADAPTER FOR ROADMASTER/SPRINGFIELD 15-16

- Designed to attach to OEM passenger board mounts on models with OEM passenger boards to allow installation of Kuryakyn floorboards or footpegs that accept splined adapters
- Sold in pairs

SUG. RETAIL \$34.99 **PART # 1621-0708**

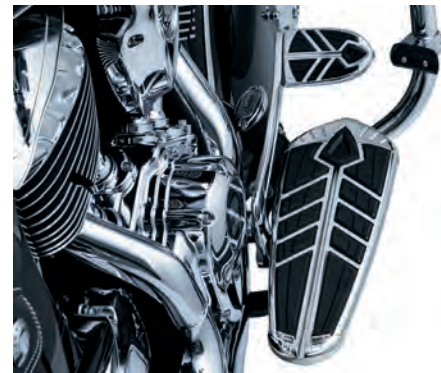

SPEAR DRIVER FLOORBOARD INSERTS FOR INDIAN 14-16 (ALL MODELS EXCEPT SCOUT)

- Have a slight larger profile than the stock inserts
- Use 1/4" spacers for improved foot positioning and better comfort
- Proprietary EPDM premium rubber compound for less vibration through the boards and better long-ride comfort
- Measure 15.5" L x 5.75" W (at widest point)
- Sold in pairs

SUG. RETAIL \$169.99 **PART # 1621-0742**

All part numbers in **BOLD MAGENTA** are new this year.

VICTORY

EXHAUST

LUGGAGE

SECURITY

WINDSHIELDS

FAIRINGS & BODY

SEATS & Sissy BARS

HANDLEBARS & HAND CONTROLS

FOOTPEGS & FOOT CONTROLS

LIGHTING

ELECTRICAL

WHEELS & ACCESSORIES

BRAKES & SUSPENSION

ENGINE

FUEL/AIR SYSTEMS

INDIAN

EXHAUST

WINDSHIELDS

FAIRINGS & BODY

SEATS & Sissy BARS

HANDLEBARS & HAND CONTROLS

FOOTPEGS & FOOT CONTROLS

LIGHTING

ELECTRICAL

WHEELS & BRAKES

SUSPENSION

ENGINE

FUEL/AIR SYSTEMS



V-LINE DRIVER FLOORBOARDS FOR INDIAN MODELS EXCLUDING SCOUT 12-17

- CNC-machined with a timeless clean design and knurled corners for added grip
- Longer length to provide any rider with additional foot placement and comfort
- Available in chrome or Reverse Cut gloss black powder-coat finish
- Made in the U.S.A.



1621-0655



1621-0656

SUG. RETAIL **\$519.95**

DESCRIPTION	PART #
Chrome	1621-0655

DESCRIPTION	PART #
Reverse Cut	1621-0656



V-LINE FOOTPEGS FOR INDIAN SCOUT 15-17, SCOUT 60 15-17

- Complement the rest of the V-line billet products
- Include mounting hardware
- Available in chrome or Reverse Cut gloss black powder-coat finish
- Made in the U.S.A.



1620-1646



1620-1645



1620-1331



1620-1644

DESCRIPTION	PART #	SUG. RETAIL
DRIVER FOOTPEGS		
Reverse Cut	1620-1646	\$139.95
Chrome	1620-1645	139.95

DESCRIPTION	PART #	SUG. RETAIL
PASSENGER FOOTPEGS		
Reverse Cut	1620-1330	\$139.95
Chrome	1620-1331	139.95

DESCRIPTION	PART #	SUG. RETAIL
PASSENGER FOOTPEGS (CONT)		
Passenger peg relocation kit	1620-1644	\$179.95



V-LINE SHIFT PEGS FOR ALL INDIAN MODELS EXCLUDING SCOUT 12-17

- Adds a subtle and clean finishing touch to the V-line series of billet parts
- Includes mounting hardware
- Available in chrome or Reverse Cut gloss black powder-coat finish
- Made in the U.S.A.



1603-0283



1603-0284

SUG. RETAIL **\$54.95**

DESCRIPTION	PART #
Reverse Cut	1603-0283

DESCRIPTION	PART #
Chrome	1603-0284



FLOORBOARD MOUNTING KIT FOR INDIAN SCOUT 15-17, SCOUT 60 16-17

- Replaces the stock forward control pegs with a more comfortable option
- Allows the rider to adjust their feet for comfort and preferred riding position
- Uses the stock mounting locations and is easy to install
- Utilizes OEM Indian floorboards
- Made in the U.S.A.



SUG. RETAIL **\$334.95**

PART #	FITS MODEL
1621-0734	INDIAN

PART #	FITS MODEL
1601-0470	INDIAN (CONT)
	Chief 14-17

SUG. RETAIL **\$1,155.95**

PART #	FITS MODEL
1601-0469	INDIAN (CONT)
	Scout 15-17



ELECTRIC EASY SHIFT SPEED SHIFTER KITS

- Easy shifting for rider comfort and convenience or for speed for the performance-oriented rider
- For performance, this is the best bang-for-your-buck product
- Gain a minimum of one bike length per shift
- Shift up at partial or full throttle and back down with the push of a button
- Eliminate the need to shift with your foot or clutch
- OEM shifting ability is retained after installation
- Clutch use is still required for starting and stopping when using these kits
- Use state-of-the-art control module to send a signal from the button control to the shift solenoid
- Kits include a stylish dual-button shift control for upshifts/downshifts, a chrome-plated electronic shift cylinder, ignition kill module, control modules and all necessary brackets
- Made in the U.S.A.



1601-0470



1601-0469

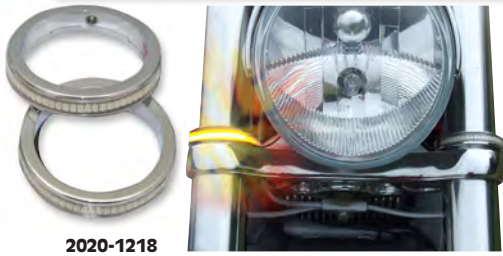

2020-1218

WRAP-AROUND LED MARKER LIGHTS

- Each light has 30 super-bright amber LEDs
- Clear or smoke lens available
- Housings are 6061 billet aluminum with a chrome or gloss black finish
- Order based on outside diameter of the fork tubes; see chart
- Sold in pairs
- Made in the U.S.A.

NOTE: Load equalizer may be required.

DESCRIPTION	LENS	PART #
43MM		
Chrome	Clear	2020-1218
	Smoke	2020-1219
Black	Clear	2020-1220
	Smoke	2020-1221



2020-1220



2020-1280



2020-1281



TURN SIGNALS WITH DAYTIME RUNNING LIGHTS (DRL)

- T 6061 billet aluminum housings in chrome or gloss black finish
- 15 super-bright White Daytime Running Light (DRL) LEDs per side
- 15 super-bright Amber Turn Signal LEDs per side
- Available with smoke lens
- Available for: 39mm, 41mm, 43mm, 49mm and 56mm forks

DESCRIPTION	CHROME	BLACK
39mm	2020-1281	2020-1280
41mm	2020-1283	2020-1282
43mm	2020-1285	2020-1284

SUG. RETAIL \$279.95

DESCRIPTION	CHROME	BLACK
49mm	2020-1287	2020-1286
56mm	2020-1289	2020-1288



2040-1907

TUBE CLAMPS FOR LED BILLET BULBETS

- Rubber inner sleeve protects tube finish
- Set screw for secure mounting (Allen wrench included)
- 5/16" mounting hole
- Sold in pairs

DESCRIPTION	CHROME	BLACK
1 5/16"	2040-1907	2040-1908
1.25"	2040-1909	2040-1910
1.5"	2040-1911	2040-1912



2040-1908



SUG. RETAIL \$44.95

DESCRIPTION	CHROME	BLACK
1.75"	2040-1913	2040-1914
2"	2040-1915	2040-1916

KURYAKYN CHROME DRIVING LIGHT BEZELS FOR INDIAN CHIEFTAIN/ROADMASTER 14-16

- Lightweight ABS plastic construction with a show-chrome finish
- Simple to install
- Sold in pairs



SUG. RETAIL \$59.99 PART # **2001-0945**



KURYAKYN

REAR FENDER STRIP LIGHTS

FOR ALL INDIAN MODELS 14-16 (EXCEPT SCOUT)

- Chrome housing has a gentle curve and contains a series of bright red dual-function LEDs
- Strips measure approximately 12" long
- Plug-and-play wiring installation
- Install quickly using high-strength 3M® VHB™ adhesive
- Sold in pairs

SUG. RETAIL \$169.99 PART # **2040-1823**

All part numbers in **BOLD MAGENTA** are new this year.



KURYAKYN

TRUNK LIGHT ACCENT

FOR INDIAN ROADMASTER 15-16, CHIEFTAIN 14-16 WITH TOUR TRUNK

- Injection-molded ABS accent matches the stock chrome housing
- Brilliant chrome finish
- Installs quickly with high-strength 3M® VHB™ adhesive

SUG. RETAIL \$49.99 PART # **2040-1863**

VICTORY

EXHAUST

LUGGAGE

SECURITY

WINDSHIELDS

FAIRINGS & BODY

SEATS & SISSY BARS

HANDLEBARS & HAND CONTROLS

FOOTPEGS & FOOT CONTROLS

LIGHTING

ELECTRICAL

WHEELS & ACCESSORIES

BRAKES & SUSPENSION

ENGINE

FUEL/AIR SYSTEMS

INDIAN

EXHAUST

WINDSHIELDS

FAIRINGS & BODY

SEATS & SISSY BARS

HANDLEBARS & HAND CONTROLS

FOOTPEGS & FOOT CONTROLS

LIGHTING

ELECTRICAL

WHEELS & BRAKES

SUSPENSION

ENGINE

FUEL/AIR SYSTEMS



2 3/8" LED DRIVING LIGHT KIT FOR INDIAN SCOUT 15-16

- MR16 high-output and high-intensity Litespan LED 2 3/8" driving light kit is available in a universal cruiser fitment
- Custom die-cast aluminum lights and fork mounts make an ideal fit on many cruisers
- The Litespan LED reflector bulbs produce 400 lumens each from 7 watt 6-LED output in bright white 4000K color
- Their concentrated 20° beam angle puts more light down the road in front of riders for a true driving light function
- The die-cast clamps fit cruisers with 38mm to 41mm forks and come with a wire harness, relay and switch



SUG. RETAIL \$189.95 PART # **2001-1325**



2001-1342



2001-1343



2001-1340



2001-1339



HIGHWAY BAR LED MINI DRIVING LIGHT KITS

- Available with 50W halogen or 7W/400 lumens/4000K LED lights
- Pair of die-cast 2 3/8" visored mini driving lights
- Includes pair of 1 1/4" highway bar clamps; additional clamps available separately
- Comes complete with wiring harness and isolation relay to protect your bike's circuit along with a choice of two styles of switches



1624-0318

DESCRIPTION	PART #	SUG. RETAIL
Halogen kit	2001-1342	\$119.95
LED kit	2001-1343	149.95
Pair of 1 1/4" clamps	1624-0318	22.95



MINI DRIVING LIGHTS

- Available in halogen or LED
- Die-cast body with smooth design comes in aluminum or black finish
- Visor integrated into bezel; setscrew allows visor to rotate to desired position for custom installation
- 3 3/4" L x 2 3/8" dia.; 8mm stem
- Halogen features 55W, 12V bulb
- LED features 7W, six 12V bulbs
- Sold each

DESCRIPTION	PART #	SUG. RETAIL
HALOGEN		
Aluminum	2040-0488	\$49.95
Black	2001-1340	49.95
LED		
Aluminum	2001-1339	65.95
Black	2001-1341	65.95

INDIAN

EXHAUST

WINDSHIELDS

FAIRINGS & BODY

SEATS & Sissy BARS

HANDLEBARS & HAND CONTROLS

FOOTPEGS & FOOT CONTROLS

LIGHTING

ELECTRICAL

WHEELS & BRAKES

SUSPENSION

ENGINE

FUEL/AIR SYSTEMS



REAR RED LED TURN SIGNALS FOR INDIAN MODELS 14-16 (EXCEPT SCOUT)

- Plug-n-play
- For use with Badlands Illuminator module PART #2050-0260; sold separately at right
- Sold in pairs

SUG. RETAIL \$119.95 PART # **2020-1279**



BADLANDS ILLUMINATOR MODULE FOR ALL INDIAN MODELS 14-16 (EXCEPT SCOUT)

- Designed to add running light, brake light and turn signal functions to each rear turn signal
- Features a built-in load equalizer that is perfect for switching out factory turn signals to halogen or LED versions
- Plug-n-play design for easy installation
- Made in the U.S.A.

SUG. RETAIL \$118.95 PART # **2050-0260**



EVO3 LIGHTWEIGHT LITHIUM-ION BATTERIES

- EVO3 is the latest evolution of lightweight Lithium-Ion batteries built to fit the OEM battery compartment, but with multiple power options
- The lightest, most powerful starter battery available, no matter what you ride
- State-of-the-art Lithium Ferrous Phosphate (LiFePO4) technology
- Extremely durable with an exceptional static self-charge rate of only 10% per year
- Up to 10 lb. lighter than the stock battery
- "Dry" technology that can be mounted in any direction
- Extensively tested by professional race teams
- Environmentally friendly, non-toxic and recyclable
- Designed, developed and assembled in the U.S.A.

NOTE: Operating environment: 0°F (-18°C) to 140°F (60°C)

NOTE: For applications used in cold environments or with high-performance modifications, we recommend using the EVO3 Upgrade. The EVO3 Upgrade is dimensionally the same, but has higher burst cranking amps.

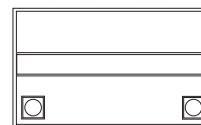

FITS MODEL	EVO3	EVO3 UPGRADE
INDIAN		
1638 Chief 02-03	2113-0354	2113-0355

PART #	DESCRIPTION	BURST CRANKING AMPS (5 SEC. AT 70°F)	AMP HOURS	DIMENSIONS	WEIGHT (LB.)	LEFT POST	RIGHT POST	SUG. RETAIL
2113-0354	EVO3 EVX20L-16	480	9.2	6.9" L X 3.4" W X 6.1" H	3.8	-	+	\$299.95
2113-0355	EVO3 EVX20L-24	720	13.8	6.9" L X 3.4" W X 6.1" H	4.8	-	+	419.95



YUASA BATTERY BATTERIES

• Yuasa is the world's largest manufacturer of motorcycle batteries and has over 50 years of expertise behind its product

HIGH-PERFORMANCE AGM MAINTENANCE-FREE BATTERY

- This new generation of maintenance-free batteries delivers higher cranking amps for vehicles that require extra starting power
- Additional cranking amps make these one of the most powerful batteries on the market
- Acid pack included, except where noted as Factory-activated

NOTE: Factory-activated batteries should be charged once a month when not in service.

AGM (MAINTENANCE-FREE) BATTERY

- Special absorbed-glass mat battery eliminates water loss, permitting the battery to be permanently sealed once it is filled with acid; Acid Pak included
- Truly the world's finest "install it and forget it" motorcycle battery

PART #	SUG. RETAIL	PART #	SUG. RETAIL
HIGH-PERFORMANCE AGM MAINTENANCE-FREE BATTERIES		AGM (MAINTENANCE-FREE) BATTERIES	
2113-0104¹	\$129.95	YTX-20BS	\$119.95
YTX20H-BS	127.95	YTX20L-BS	119.95
YTX24HL²	148.95		
YTX20HL-BS	127.95		
YTX24HL-BS	146.95		

¹ Factory-Activated; Yuasa reference #YTX20HL.
² Factory-Activated.

DISCLAIMER: NOT LEGAL FOR SALE OR USE IN CALIFORNIA ON ANY POLLUTION CONTROLLED MOTOR VEHICLES. SEE PAGE 3 FOR IMPORTANT EMISSION DEFINITIONS AND REGULATORY COMPLIANCE AND WARRANTY INFORMATION.

All part numbers in **BOLD MAGENTA** are new this year.

- VICTORY
- EXHAUST
- LUGGAGE
- SECURITY
- WINDSHIELDS
- FAIRINGS & BODY
- SEATS & SIGGY BARS
- HANDLEBARS & HAND CONTROLS
- FOOTPEGS & FOOT CONTROLS
- LIGHTING
- ELECTRICAL
- WHEELS & ACCESSORIES
- BRAKES & SUSPENSION
- ENGINE
- FUEL/AIR SYSTEMS
- INDIAN**
- EXHAUST
- WINDSHIELDS
- FAIRINGS & BODY
- SEATS & SIGGY BARS
- HANDLEBARS & HAND CONTROLS
- FOOTPEGS & FOOT CONTROLS
- LIGHTING
- ELECTRICAL**
- WHEELS & BRAKES
- SUSPENSION
- ENGINE
- FUEL/AIR SYSTEMS

VICTORY

EXHAUST

LUGGAGE

SECURITY

WINDSHIELDS

FAIRINGS & BODY

SEATS & Sissy BARS

HANDLEBARS & HAND CONTROLS

FOOTPEGS & FOOT CONTROLS

LIGHTING

ELECTRICAL

WHEELS & ACCESSORIES

BRAKES & SUSPENSION

ENGINE

FUEL/AIR SYSTEMS

INDIAN

EXHAUST

WINDSHIELDS

FAIRINGS & BODY

SEATS & Sissy BARS

HANDLEBARS & HAND CONTROLS

FOOTPEGS & FOOT CONTROLS

LIGHTING

ELECTRICAL

WHEELS & BRAKES

SUSPENSION

ENGINE

FUEL/AIR SYSTEMS



AGM MAINTENANCE-FREE BATTERIES

- Parts Unlimited is proud to offer a premium-quality maintenance-free battery and a great low price
- Special absorbed-glass mat battery eliminates water loss, permitting the battery to be permanently sealed once it is filled with acid
- Acid pak included
- Truly the world's finest "install it and forget it" motorcycle battery
- Battery seals to prevent water loss
- Holds charge three times longer than conventional batteries



YUASA REFERENCE #	PART #	SUG. RETAIL	YUASA REFERENCE #	PART #	SUG. RETAIL	YUASA REFERENCE #	PART #	SUG. RETAIL
YTX20H-BS	2113-0021	\$78.95	YTX20HL-BS	2113-0022	\$78.95	YTX24HL-BS	2113-0205	\$108.95



2113-0011



2113-0012



2113-0013



HIGH PERFORMANCE BATTERIES

- Specifically designed for high-performance engines that need extra cranking power
- Superior engineering features include an AGM (Absorbed glass-matt) radial grid design for maximum cranking amps
- High vibration resistance
- Spill-proof, pre-filled, pre-charged, maintenance-free sealed design
- Batteries include brass spacers, stainless steel nuts, bolts and star washers
- Made in the U.S.A.

NOTE: Factory-activated batteries should be charged once a month when not in service.

PART #	YUASA REFERENCE #	SUG. RETAIL
2113-0011	YTX20H	\$116.95
2113-0012	YTX20HL	116.95
2113-0013	YTX24HL	132.95

FACTORY-ACTIVATED PART #	YUASA REF. #	COLD CRANKING AMPS	LENGTH	WIDTH	HEIGHT	TERMINAL CONFIGURATION
2113-0011	YTX20H-BS	310	6 ⁷ / ₈ "	3 ⁷ / ₁₆ "	6 ¹ / ₈ "	+ -
2113-0012	YTX20HL-BS	310	6 ⁷ / ₈ "	3 ⁷ / ₁₆ "	6 ¹ / ₈ "	- +
2113-0013	YTX24HL-BS	350	8 ¹ / ₈ "	3 ⁷ / ₁₆ "	6 ⁵ / ₈ "	- +

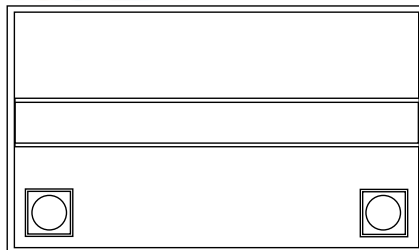

DISCLAIMER: NOT LEGAL FOR SALE OR USE IN CALIFORNIA ON ANY POLLUTION CONTROLLED MOTOR VEHICLES. SEE PAGE 3 FOR IMPORTANT EMISSION DEFINITIONS AND REGULATORY COMPLIANCE AND WARRANTY INFORMATION.



DS-325030



POWER MAX MAINTENANCE-FREE BATTERIES

- Completely sealed black case can be mounted in almost any position
- Advanced technology allows very high power discharge
- Accept a high rate of recharge without damage to the battery
- Can be recharged over 90% in less than one hour on a regulated charger
- Battery **MUST BE CHARGED** in the same manner as any lead acid battery
- When not in service, battery should be charged once a month

YUASA REFERENCE #	PART #	SUG. RETAIL	YUASA REFERENCE #	PART #	SUG. RETAIL	YUASA REFERENCE #	PART #	SUG. RETAIL
YTX20-BS	DS-325030	\$111.95	YTX20L-BS	DS-325024	\$111.95	YIX24HL-BS	2113-0223	\$119.95

YUASA BATTERY

BATTERY APPLICATIONS CHART

FITS MODEL	YUASA HIGH-PERFORMANCE AGM MAINTENANCE-FREE	YUASA AGM MAINTENANCE FREE	PARTS UNLIMITED AGM MAINTENANCE-FREE	DRAG SPECIALTIES HIGH-PERFORMANCE BATTERIES
INDIAN				
Chief Classic, Chief Vintage, Chieftain 14	2113-0104²	-	-	2113-0012
Chief Classic, Vintage, Dark Horse 12-13	YTX24HL-BS²	-	2113-0205	2113-0013
Chief 09-11 (all)	YTX20H-BS	YTX-20BS	2113-0021	2113-0011
1638 Chief 02-03	YTX20HL-BS	YTX20L-BS¹	2113-0022	2113-0012
1442 Scout, Spirit 02-03	YTX24HL-BS²	-	2113-0205	2113-0013
All models 99-01	YTX20H-BS	YTX-20BS	2113-0021	2113-0011

¹ Factory-Activated, High-Performance AGM Maintenance-Free battery also available, PART #2113-0104.

² Factory-Activated, High-Performance AGM Maintenance-Free battery also available, PART #YTX24HL.

³ Factory-Activated.



RECTIFIER/REGULATOR

- OEM-style rectifier/regulator
- Made in the U.S.A.

SUG. RETAIL **\$149.95**

FITS MODEL	PART #
INDIAN	
Chief Classic 14-15	2112-1151
Chief Vintage 14-15	2112-1151
Chieftain 14-15	2112-1151
Roadmaster 15	2112-1151



IGNITION COILS

- Increased spark energy
- Direct OE replacement
- Cost-effective replacement

SUG. RETAIL **\$179.95**

MODEL	PART #
INDIAN	
Chief classic 12-15	2102-0330
Chief vintage 12-15	2102-0330
Chieftain 14-15	2102-0330
Roadmaster 15	2102-0330
Dark Horse 12-13	2102-0330

DISCLAIMER: NOT LEGAL FOR SALE OR USE IN CALIFORNIA ON ANY POLLUTION CONTROLLED MOTOR VEHICLES. SEE PAGE 3 FOR IMPORTANT EMISSION DEFINITIONS AND REGULATORY COMPLIANCE AND WARRANTY INFORMATION.

All part numbers in **BOLD MAGENTA** are new this year.

partsnetweb.com / dragnetweb.com

VICTORY

EXHAUST

LUGGAGE

SECURITY

WINDSHIELDS

FAIRINGS & BODY

SEATS & SISSY BARS

HANDLEBARS & HAND CONTROLS

FOOTPEGS & FOOT CONTROLS

LIGHTING

ELECTRICAL

WHEELS & ACCESSORIES

BRAKES & SUSPENSION

ENGINE

FUEL/AIR SYSTEMS

INDIAN

EXHAUST

WINDSHIELDS

FAIRINGS & BODY

SEATS & SISSY BARS

HANDLEBARS & HAND CONTROLS

FOOTPEGS & FOOT CONTROLS

LIGHTING

ELECTRICAL

WHEELS & BRAKES

SUSPENSION

ENGINE

FUEL/AIR SYSTEMS

VICTORY

EXHAUST

LUGGAGE

SECURITY

WINDSHIELDS

FAIRINGS & BODY

SEATS & Sissy BARS

HANDLEBARS & HAND CONTROLS

FOOTPEGS & FOOT CONTROLS

LIGHTING

ELECTRICAL

WHEELS & ACCESSORIES

BRAKES & SUSPENSION

ENGINE

FUEL/AIR SYSTEMS

INDIAN

EXHAUST

WINDSHIELDS

FAIRINGS & BODY

SEATS & Sissy BARS

HANDLEBARS & HAND CONTROLS

FOOTPEGS & FOOT CONTROLS

LIGHTING

ELECTRICAL

WHEELS & BRAKES

SUSPENSION

ENGINE

FUEL/AIR SYSTEMS



PLUG WIRES FOR INDIAN 09-13 (ALL)

- Constructed with silicone throughout the jacket, insulation and core to deliver high-temperature resistance
- Rated at SAE Class E J2031 with a continuous operating temperature of 450° F
- Made in the U.S.A.

SUG. RETAIL\$35.95 PART # **2104-0296**



2120-0868



24" HANDLEBAR EXTENSION HARNESSES

- Complete plug-and-play kit includes throttle-by-wire and all the items needed to successfully extend the wiring to a set of OEM handlebar switches
- Made in the U.S.A.

FITS MODEL	PART #	SUG. RETAIL
INDIAN		
Chief, Springfield 14-16	2120-0867	\$89.95
Chieftain, Roadmaster 14-16	2120-0868	99.95



ROCKER SWITCH

- Switch has 8A @ 12V load on one side and 10A @ 30V load on other
- Measures approximately 0.480" x 1.072"
- Available in black



SUG. RETAIL\$2.95 PART # **2106-0385**



LACED WHEEL ASSEMBLIES

- Classic spoke design
- Available in 50 or 60 spoke styles
- Chrome billet aluminum hubs with polished stainless steel spokes and polished stainless steel nipples
- Chrome-plated steel rims
- Wheels come completely assembled and are trued to less than .005" runout
- DOT approved
- Accept CMV tubes (except 16"x3.5" wheels, which use an SMV tube)
- Sealed design allows tubeless tires to be used
- Stock pulleys and rotors can be used
- Front and rear applications for most popular models
- Sizes available for custom applications
- Made in the U.S.A. by RideWright Wheels

NOTE: 21" front wheel applications cannot use factory front fender. It is the installer's responsibility to determine the required changes.



0203-0603



0204-0502

SIZE	50-SPOKE	SUG. RETAIL	60-SPOKE	SUG. RETAIL
FRONT WHEELS				
ALL INDIAN MODELS 14-16 (EXCEPT SCOUT 15-16)				
16 x 3.50	0203-0603	\$1,199.95	0203-0604	\$1,099.95
18 x 3.50	0203-0605	1,239.95	0203-0606	1,149.95
21 x 3.50	0203-0607	1,289.95	0203-0608	1,199.95
INDIAN SCOUT 15-16				
16 x 3.50	0203-0609	1,199.95	0203-0610	1,099.95
REAR WHEELS				
ALL INDIAN MODELS 14-16 (EXCEPT SCOUT 15-16)				
16 x 5.50	0204-0502	\$1,579.95	0204-0503	\$1,479.95
18 x 5.50	0204-0504	1,579.95	0204-0505	1,559.95
INDIAN SCOUT 15-16				
16 x 5.50	0204-0506	1,579.95	0204-0507	1,479.95

DISCLAIMER: NOT LEGAL FOR SALE OR USE IN CALIFORNIA ON ANY POLLUTION CONTROLLED MOTOR VEHICLES. SEE PAGE 3 FOR IMPORTANT EMISSION DEFINITIONS AND REGULATORY COMPLIANCE AND WARRANTY INFORMATION.

BRAKE PAD APPLICATION CHART

- A complete brake pad application guide
- For optional brake pad compounds available, see pages 115-117

INDIAN BRAKE PAD APPLICATION CHART

FITS MODEL	DRAG SPECIALTIES		DP BRAKES FRONT		DP BRAKES REAR		EBC FRONT	EBC REAR	SBS FRONT	SBS REAR
	FRONT PAD PART #	REAR PAD PART #	PAD PART #	PAD PART #	PAD PART #	PAD PART #	PAD PART #	PAD PART #	PAD PART #	PAD PART #
INDIAN										
All models 02-08	1721-1360	1720-0209	SDP-911HH	SDP-911HH	1721-0139	1721-0139	1721-1817	1721-1818		
All models 09	1721-1947	1721-1946	SDP-614HH	DP-701	FA95HH	FA18HH	1721-1817	1721-1818		
Chief Blackhawk (Brembo calipers) 11	1721-1947	1721-1946	SDP-614HH	DP-701	FA95HH	FA18HH	1721-1817	1721-1818		
Chief Blackhawk Dark (Brembo calipers) 11	1721-1947	1721-1946	SDP-614HH	DP-701	FA95HH	FA18HH	1721-1817	1721-1818		
Chief Classic (Brembo calipers) 11-13	1721-1947	1721-1946	SDP-614HH	DP-701	FA95HH	FA18HH	1721-1817	1721-1818		
Chief Standard (Brembo calipers) 09-11	1721-1947	1721-1946	SDP-614HH	DP-701	FA95HH	FA18HH	1721-1817	1721-1818		
Chief Deluxe (Brembo calipers) 09	1721-1947	1721-1946	SDP-614HH	DP-701	FA95HH	FA18HH	1721-1817	1721-1818		
Chief Roadmaster (Brembo calipers) 09-11	1721-1947	1721-1946	SDP-614HH	DP-701	FA95HH	FA18HH	1721-1817	1721-1818		
Chief Vintage (Brembo calipers) 09-13	1721-1947	1721-1946	SDP-614HH	DP-701	FA95HH	FA18HH	1721-1817	1721-1818		
Chief Vintage FE/LE 13	1721-1947	1721-1946	SDP-614HH	DP-701	FA95HH	FA18HH	1721-1817	1721-1818		
Bomber (Brembo Calipers) 10-11	1721-1947	1721-1948	SDP-614HH	DP-701	FA95HH	FA18HH	1721-1817	1721-1818		
Dark Horse (Brembo calipers) 10-13	1721-1947	1721-1946	SDP-614HH	DP-701	FA95HH	FA18HH	1721-1817	1721-1818		
Chief Classic (Spoke Wheel/Nissin calipers) 14-16	1721-1952	1721-1948	SDP-922HH	DP-118	FA347HH	FA196HH	1722-0674	1722-0672		
Chief Vintage (Spoke Wheel/Nissin calipers) 14-16	1721-1952	1721-1948	SDP-922HH	DP-118	FA347HH	FA196HH	1722-0674	1722-0672		
Chief Dark Horse (Nissin calipers) 16	1721-1952	1721-1948	SDP-922HH	DP-118	FA347HH	FA196HH	1722-0674	1722-0672		
Chieftain (Cast Wheel/Nissin calipers) 14-16	1721-1952	1721-1948	SDP-922HH	DP-118	FA347HH	FA196HH	1722-0674	1722-0672		
Scout (Cast Wheel/Toso calipers) 16	1721-1948	-	-	-	FA196HH	-	-	-		
Roadmaster (Cast Wheel/Nissin calipers) 15-16	1721-1952	-	SDP-922HH	DP-118	FA347HH	FA196HH	1722-0674	1722-0672		



BRAKE PADS

- Sintered metal brake pads are the OEM-type replacement pads for most bikes from the late 1970s to the present
- Sintered metal brake pads are proudly made in the U.S.A.; second-to-none in their stopping abilities and wear characteristics, while still providing excellent reduction in noise and dust
- Organic pads are OEM type replacement brake pads for 1970s and earlier models
- Organic pads with aramid high-performance fibers are the perfect choice for polished or chromed rotors and billet steel rotors
- Both compounds of Drag Specialties brake pads are asbestos-, nickel- and lead-free

NOTE: All brake pad applications PART #s shown are sintered metal compound pads, unless noted in chart.

NOTE: Pads are 8mm thick.

NOTE: If you are using aftermarket billet steel rotors, it is recommended you use our Organic pads with aramid high-performance fiber brake pads to avoid damage to them. Sintered pads are not recommended for billet steel rotors as the pad material is too aggressive for those rotors.

FITS CALIPER	DESCRIPTION	PART #	FITS CALIPER	DESCRIPTION	PART #
PERFORMANCE MACHINE			PERFORMANCE MACHINE (CONT)		
125 X 4R (0052-1602)	Sintered metal	1721-1360	125 X 4RSPH (0052-1602)	Sintered metal	1721-1360
	Organic	1720-0209		Organic	1720-0209
137 X 4B (0052-1602)	Sintered metal	1721-1360			
	Organic	1720-0209			

BRAKE PAD CROSS-REFERENCE CHART

SINTERED METAL PAD PART #	SEMI-METALLIC PART #	ORGANIC PAD PART #	SINTERED METAL PAD PART #	SEMI-METALLIC PART #	ORGANIC PAD PART #
1721-1360	-	1720-0209	1721-1948	1721-2253	1720-0278
1721-1946	-	1720-0276	1721-1952	-	-
1721-1947	-	1720-0277	-	1721-2254	-

PRICE LIST

PART #	SUG. RETAIL	PART #	SUG. RETAIL	PART #	SUG. RETAIL	PART #	SUG. RETAIL
1720-0209	\$19.95	1720-0278	\$21.95	1721-1947	\$24.95	1721-2253	\$24.95
1720-0276	20.95	1721-1360	33.95	1721-1948	29.95	1721-2254	24.95
1720-0277	20.95	1721-1946	32.95	1721-1952	27.95		

All part numbers in **BOLD MAGENTA** are new this year.

VICTORY

EXHAUST

LUGGAGE

SECURITY

WINDSHIELDS

FAIRINGS & BODY

SEATS & Sissy BARS

HANDLEBARS & HAND CONTROLS

FOOTPEGS & FOOT CONTROLS

LIGHTING

ELECTRICAL

WHEELS & ACCESSORIES

BRAKES & SUSPENSION

ENGINE

FUEL/AIR SYSTEMS

INDIAN

EXHAUST

WINDSHIELDS

FAIRINGS & BODY

SEATS & Sissy BARS

HANDLEBARS & HAND CONTROLS

FOOTPEGS & FOOT CONTROLS

LIGHTING

ELECTRICAL

WHEELS & BRAKES

SUSPENSION

ENGINE

FUEL/AIR SYSTEMS

DP BRAKES THE ORIGINAL SINTERED BRAKES



- DP Brakes brake pads are designed with sintered metal compounds to give your bike high-tech performance in all conditions
- Pads have a quick break-in period so you get maximum performance fast
- DP Brakes design and materials ensure consistent hard stops and fade-free performance
- Sintered metal compounds outlast more conventional organic or Kevlar® pads

STANDARD SINTERED METAL BRAKE PADS

- GG friction rated and made with DP Brakes' proven sintered metal material
- Gray-colored aluminum oxide-based ceramic material on rear of backing plate keeps heat away from caliper piston and fluid in extreme conditions for fade-free performance
- Pad compound gives equal performance in wet or dry conditions
- Ideal replacement for street and touring machines where durability is the prime requirement
- No brake fade

SPORT HH+ SUPERSPORT PADS

- Powerful, industry-high HH+ friction rating with no mileage penalty
- High-tech ceramic heat shield eliminates brake fade
- Dust-free compound design
- Quick break-in so you get maximum braking ability fast
- For front wheel use only

NOTE: For brake pad applications, see chart on page 115.



BRAKE PAD CROSS-REFERENCE CHART

DP BRAKES PAD #	STANDARD PAD PART #	SPORT HH+ PAD PART #	DP BRAKES PAD #	STANDARD PAD PART #	SPORT HH+ PAD PART #
118	DP-118	-	911	-	SDP-911HH
614	-	SDP-614HH	922	-	SDP-922HH
701	DP-701	-			

PRICE LIST

PART #	SUG. RETAIL	PART #	SUG. RETAIL	PART #	SUG. RETAIL	PART #	SUG. RETAIL	PART #	SUG. RETAIL
DP-118	\$48.95	DP-701	\$43.95	SDP-614HH	\$48.95	SDP-911HH	\$42.95	SDP-922HH	\$48.95



BRAKE PADS

- SBS brake pads feature asbestos-free brakes using patented Unified Composite Technology (UCT)
- UCT technology completely blends all brake pad materials into a balanced, unified pad
- This balance ensures no hot spots, glazing, premature fading or excessive rotor wear
- The result is powerful, fade-free braking performance, even in extreme conditions



1722-0672

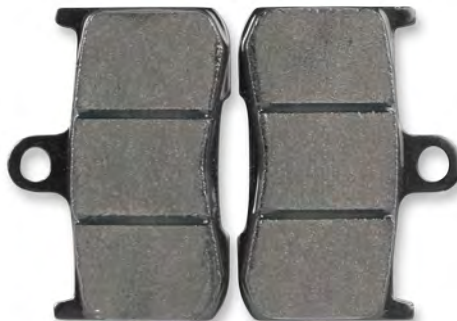

1722-0674



STREET EXCEL SINTERED METAL PADS

- The best in sintered replacement pads for high-performance front (HS) and rear (LS) street applications
- Use advanced sintering process technology; perfect for sport riding
- The highest coefficient of friction in the lineup to provide maximum stopping power
- Formulation also offers high fade-resistance and quick cool-down under severe braking
- When you need to replace your worn sintered metal pads, choose STREETExcel; the sinter compounds with the power to stop you

NOTE: For brake pad applications, see chart on page 115.

BRAKE PAD CROSS-REFERENCE CHART

SBS PAD #	HS STREET EXCEL SINTERED METAL FRONT PAD PART #	LS STREET EXCEL SINTERED METAL REAR PAD PART #
630	-	1722-0672
678	1721-1817	1721-1818
782	1722-0674	-

PRICE LIST

PART #	SUG. RETAIL	PART #	SUG. RETAIL	PART #	SUG. RETAIL	PART #	SUG. RETAIL
1721-1817	\$44.95	1721-1818	\$46.95	1722-0672	\$41.95	1722-0674	\$41.95

EBC BRAKES BRAKE PADS

ORGANIC BRAKE PADS

- The world's #1 selling organic disc brake pads
- EBC brake pads contain aramid fibers; these are man-made high-performance fibers used widely for their light weight, high strength, abrasion resistance and thermal stability
- Aramid fibers have high strength-to-weight, thermal stability and abrasion resistance to provide advantages over cheaper steel fiber-based products
- Provide excellent stopping power without noise and rotor galling, even on polished rotors
- Fingertip control and strong, predictable brake response



Organic pads

DOUBLE-H SINTERED METAL PADS

- Feature the HH friction rating – the highest in the industry
- Provide maximum brake effect and last twice as long as organic pads
- Sintered pads are manufactured in the U.S.A.



Double-H sintered pads



Semi-sintered "V" pads



SEMI-SINTERED "V" PADS

- All-new semi-sintered construction containing 30% copper by weight within an organic matrix
- This design combines the long life of a sintered pad with the great feel and lack of rotor damage common with sintered pads
- Can be used to replace organic or sintered metal compound pads

NOTE: For brake pad applications see chart on page 115.

BRAKE PAD CROSS-REFERENCE CHART

EBC PAD #	ORGANIC PAD PART #	DOUBLE-H SINTERED METAL PAD PART #	"V" SEMI-SINTERED PAD PART #	EBC PAD #	ORGANIC PAD PART #	DOUBLE-H SINTERED METAL PAD PART #	"V" SEMI-SINTERED PAD PART #
18	FA18	FA18HH	-	216/3	FA216/3	1721-0139	1721-1416
95	FA95	FA95HH	1721-1450	347	-	FA347HH	-
196	1720-0021	FA196HH	1721-1411				

PRICE LIST

PART #	SUG. RETAIL	PART #	SUG. RETAIL	PART #	SUG. RETAIL	PART #	SUG. RETAIL	PART #	SUG. RETAIL
FA18	\$29.95	FA95HH	\$38.95	FA244	\$34.95	1721-0139	\$38.95	1721-1450	\$35.95
FA18HH	38.95	FA196HH	38.95	FA347HH	38.95	1721-1411	34.95		
FA95	29.95	FA216/3	31.95	1720-0021	31.95	1721-1416	34.95		

EZ-ALIGN BRAIDED SINGLE DISC NON-ABS FRONT BRAKE LINES

- E-Z Align rotating caliper banjo feature for perfect no-kink fitments
- All fittings are polished and chrome or black chrome plated
- The industry's highest-quality braid available in two color choices to complement your bike; Sterling Chromite II® and Black Pearl braided with black wire
- Braid color and weave match on all Magnum control cables and brake lines
- Crystal-clear outer jacket offers exceptional protection against scuffing paint or chrome and will never discolor
- Inner PTFE tubing braided with Kevlar® greatly reduces line expansion and provides the ultimate in high performance
- Exceeds all DOT FMVSS-106 Specifications
- Made in the U.S.A.



FITS MODEL	COLOR	OEM #	STOCK	+2"	+4"	+6"	+8"
INDIAN							
Scout/Scout Sixty 15-16	Sterling Chromite II	1912416	1741-4663	1741-4664	1741-4665	1741-4666	1741-4667
	Black Pearl	1912416	1741-4675	1741-4676	1741-4677	1741-4678	1741-4679

PART #	SUG. RETAIL	PART #	SUG. RETAIL	PART #	SUG. RETAIL	PART #	SUG. RETAIL	PART #	SUG. RETAIL
1741-4663	\$68.95	1741-4665	\$70.95	1741-4667	\$72.95	1741-4676	\$69.95	1741-4678	\$71.95
1741-4664	69.95	1741-4666	71.95	1741-4675	68.95	1741-4677	70.95	1741-4679	72.95

All part numbers in **BOLD MAGENTA** are new this year.

VICTORY

EXHAUST

LUGGAGE

SECURITY

WINDSHIELDS

FAIRINGS & BODY

SEATS & Sissy BARS

HANDLEBARS & HAND CONTROLS

FOOTPEGS & FOOT CONTROLS

LIGHTING

ELECTRICAL

WHEELS & ACCESSORIES

BRAKES & SUSPENSION

ENGINE

FUEL/AIR SYSTEMS

INDIAN

EXHAUST

WINDSHIELDS

FAIRINGS & BODY

SEATS & Sissy BARS

HANDLEBARS & HAND CONTROLS

FOOTPEGS & FOOT CONTROLS

LIGHTING

ELECTRICAL

WHEELS & BRAKES

SUSPENSION

ENGINE

FUEL/AIR SYSTEMS



970 SERIES PIGGYBACK SHOCKS FOR INDIAN SCOUT 15-16

- Progressive Suspension does it once again!
- Designed for performance-oriented twin shock bikes
- Feature piggyback reservoirs, high-pressure gas charge and deflective disc-valving, all packaged in a mono-tube style body
- Include progressive rate springs
- The threaded preload adjustment and external compression adjustment knob allow for fine-tuning to provide optimum performance for rider weight or riding style
- 12" L



SUG. RETAIL \$1,199.00

PART #

1310-1320



FRONT FORK SPRINGS FOR INDIAN SCOUT 15-16 MODELS

- Progressive springs offer a soft initial spring rate for a plush ride
- Progressively wound design provides increased resistance to bottoming as spring compresses
- Improve handling while retaining OEM geometry
- Sold in pairs
- Made in the U.S.A.



SUG. RETAIL \$97.00

PART #

0405-0528



FORK LOWERING KITS FOR INDIAN SCOUT 15-16

- Give Cruiser bike front ends that custom lowered look by lowering the forks
- Your choice of 1" or 2" lowering height is available at time of installation
- To maintain proper balanced geometry, it is recommended lowering the rear of the bike the same amount as the front (Progressive Suspension Series shocks available for lowering the rear); see above
- Installing a lowering kit will decrease initial ground clearance; motorcycle will be lower to the ground, and care should be taken to avoid bottoming, especially over bumps or in turns



SUG. RETAIL \$124.95

PART #

0416-0095



ADJUSTABLE RIDE HEIGHT SHOCK ABSORBER FOR INDIAN CHIEF, CHIEF CLASSIC, CHIEF VINTAGE, CHIEF DARK HORSE AND CHIEFTAIN 14-16

- Shock absorber comes pre-set at 310mm length (approximately 1.5" lower than stock)
- Shock length can be adjusted using hand tools to any range from factory height to 1.5" lower than stock
- Spring rate is adjusted for a 200 lb. rider
- Adjustable spring pre-load



SUG. RETAIL \$329.95

PART #

1310-1261



V-LINE FORK TUBE COVERS FOR INDIAN CHIEF 15-16

- 3-D CNC-machined T6 aluminum
- Replaces the thin factory covers to give your Indian Chief a clean look
- Available in chrome or Reverse Cut gloss black powder-coat finish
- Made in the U.S.A.

SUG. RETAIL \$449.95

DESCRIPTION

PART #

Chrome

0411-0110



0411-0110



0411-0111

DESCRIPTION

Reverse Cut gloss black powder-coat

PART #

0411-0111

OIL FILTER APPLICATION CHART

FITS MODEL	DRAG SPECIALTIES BLACK PART #	DRAG SPECIALTIES CHROME PART #	HIFLOFILTRO PART #	PC RACING FLO PART #
INDIAN				
Chief Classic/Dark Horse/Vintage/Vintage LE 14-16	0712-0479	0712-0480	0712-0503	0712-0149
Chieftain 14-16	0712-0479	0712-0480	0712-0503	0712-0149
Roadmaster 15-16	0712-0479	0712-0480	0712-0503	0712-0149
Scout 15	-	-	0712-0301	-



- High-quality spin-on filter
- A dependable replacement for OEM
- Available in chrome or black

DESCRIPTION	PART #	SUG. RETAIL	DESCRIPTION	PART #	SUG. RETAIL
Black	0712-0479	\$7.95	Chrome	0712-0480	\$9.95



HIFLOFILTRO® OIL FILTER

- The original Hiflofiltro factory was founded in 1955 and has been manufacturing filters for the OEM motor industry since 1963
- With the experience of more than five decades, constant research and development and featuring a completely modern production facility Hiflofiltro offers some of the best quality filters in the world
- TÜV approved and production monitored to ensure OEM or better quality
- Constructed using the best materials available
- One of the broadest ranges of aftermarket coverage
- See application chart below

PART #	HIFLOFILTRO #	SUG. RETAIL	PART #	HIFLOFILTRO #	SUG. RETAIL	PART #	HIFLOFILTRO #	SUG. RETAIL
0712-0114	HF198	\$8.65	0712-0301	HF199	\$8.60	0712-0503	HF175	\$5.95



FLO STAINLESS STEEL, REUSABLE "SPIN-ON" OIL FILTER

- Made from laser-cut, medical-grade, 304 stainless steel micronic filter cloth, this filter provides 200% more filter area in many cases
- Stainless filter catches items down to 35 microns, which is about three times better than most good paper or brass filters
- Unlike glued paper filters, the FLO Oil Filter pleat seam is welded and able to withstand up to 600° F
- Filter maintains consistent flow under all conditions including extreme heat, the presence of water, and cold start-ups where paper filters can flow so poorly that they often cause the bypass valve to open and allow unfiltered oil to enter your engine
- Should be the last filter an owner ever needs; this high tech filter technology is widely used in all types of auto racing including NASCAR, Indy type cars, Formula 1 and in the aerospace industry where filtration is of the utmost importance
- FLO reference # PCS1
- See application chart above



SUG. RETAIL	\$129.95	PART #	0712-0149
--------------------------	-----------------	---------------------	------------------

DISCLAIMER: NOT LEGAL FOR SALE OR USE IN CALIFORNIA ON ANY POLLUTION CONTROLLED MOTOR VEHICLES. SEE PAGE 3 FOR IMPORTANT EMISSION DEFINITIONS AND REGULATORY COMPLIANCE AND WARRANTY INFORMATION.

All part numbers in **BOLD MAGENTA** are new this year.

VICTORY

EXHAUST

LUGGAGE

SECURITY

WINDSHIELDS

FAIRINGS & BODY

SEATS & Sissy BARS

HANDLEBARS & HAND CONTROLS

FOOTPEGS & FOOT CONTROLS

LIGHTING

ELECTRICAL

WHEELS & ACCESSORIES

BRAKES & SUSPENSION

ENGINE

FUEL/AIR SYSTEMS

INDIAN

EXHAUST

WINDSHIELDS

FAIRINGS & BODY

SEATS & Sissy BARS

HANDLEBARS & HAND CONTROLS

FOOTPEGS & FOOT CONTROLS

LIGHTING

ELECTRICAL

WHEELS & BRAKES

SUSPENSION

ENGINE

FUEL/AIR SYSTEMS



CARBON FIBER CLUTCH KIT FOR INDIAN CHIEF/CHIEFTAIN 14-16

- Carbon fiber
- Includes seven frictions, six steels and a set of five heavy-duty springs
- Made in the U.S.A.

SUG. RETAIL \$186.95



PART # 1131-3025



KURYAKYN INNER PRIMARY COVER FOR INDIAN 14-16 (ALL EXCEPT SCOUT)

- Die-cast aluminum construction with a chrome finish
- Quick installation using high-strength 3M® VHB™ adhesive

SUG. RETAIL \$119.99



PART # 1120-0363

KURYAKYN CHROME TAPPET BLOCK ACCENTS FOR INDIAN MODELS 14-16 (EXCEPT SCOUT)

- Finish off the OEM chrome look with this tappet block accent
- Create a unique transition from the cylinder head to the motor block
- Simple installation

SUG. RETAIL \$69.99



PART # 0940-1359



Fi2000 POWRPRO BLACK

- Requires no dyno tuning – plug it in and ride
- PowrPro Black analyzes, tunes and adjusts your air/fuel ratio for peak performance instantaneously
- Tunes acceleration fuel delivery in every gear for peak performance
- Works with stock or modified engines, air cleaners and exhaust systems
- Can fine-tune the non-acceleration air/fuel curves using the Bluetooth® app
- Can tune engine fuel delivery in specific ranges, check rpm, read fuel injector pulse width and duty cycle, and add or remove fuel in low- or mid-range rpm



SUG. RETAIL \$499.95

FITS MODEL	PART #
INDIAN Chief 14-16	1020-2653

FITS MODEL	PART #
INDIAN (CONT) Scout/Sixty 15-17	1020-2654

DISCLAIMER: NOT LEGAL FOR SALE OR USE IN CALIFORNIA ON ANY POLLUTION CONTROLLED MOTOR VEHICLES. SEE PAGE 3 FOR IMPORTANT EMISSION DEFINITIONS AND REGULATORY COMPLIANCE AND WARRANTY INFORMATION.

TECHNORESEARCH

CENTURION SUPER PRO PLUS PROFESSIONAL DIAGNOSTIC TOOL SYSTEM



- The industry's only complete professional diagnostic tool system designed for independent professional repair facilities
- Communicates with all 08-17 Victory, 03-17 Indian, 97-15 Harley-Davidson® and Buell models using the proprietary VCM-TR3 Communication Module with included cables
- Re-flash blank ECU, program VIN and Key Fobs on Harley models
- Easily perform speedometer calibration on all Harley models through 2015
- ABS bleeding and ABS solenoid-pump testing on Harley models
- Read and clear Diagnostic Trouble Codes (DTC)
- Reset air/fuel values and adjust idle rpm on Harley models
- Perform active tests on tachometer, speedometer, fuel pump, idle rpm, system relays, cooling fans, IAC, ACR compression, injectors, indicator lights, coils, coolant pump, left or right turn signals and more on Harley models
- LED indicator tests for 6th gear, ABS service, battery, check engine, cruise control, high and low beam, neutral, oil, security and coolant temp on Harley models
- View real-time data in strip chart or digital dashboard formats
- Requires use of a Windows laptop, PC or tablet; connect using either included cable or Bluetooth® wireless connection
- Fast data acquisition and many hours of data storage provides accuracy and saves time
- Can easily update software online through Technoresearch to stay current on all features, years and model types
- Included VCM-TR3 Communication Module is fully compatible with Direct Link & Tune Builder keys (sold separately)
- Includes Mobile Dyno with Android app
- Durable metal housing and easy adapter system allowing for fast switches between motorcycles
- Made in the U.S.A.

SUG. RETAIL **\$2,126.95** **PART #** **3807-0314**

VICTORY/INDIAN CENTURION PRO UPGRADE KIT

- Kit includes all cables and hardware needed to upgrade a Centurion Pro kit (PART #3807-0313) to include Victory and Indian features
- Activation code included inside package to easily unlock features
- Made in the U.S.A.



SUG. RETAIL **\$428.95** **PART #** **3807-0344**

TUNE BUILDER



1020-2409



1020-2413

- Tune Builder is an easy-to-use, professional tuning aid that saves up to 50% of the time needed to create mapping
- Quickly combines current map information with using its powerful data collection and sophisticated algorithms to automatically create tables that allows users to copy/paste completed maps into flash tuning software
- After data is collected from a motorcycle ECU, Tune Builder's Auto Mapping feature automatically generates fuel tables to create the most efficient map possible
- Can be used with all flash tuning software regardless of brand, including OE and aftermarket products
- Effortlessly tune Volumetric Efficiency (VE) tables, detect and remove spark knock and evaluate engine usage areas
- Log up to 16 channels simultaneously and at high frequency
- Record and seamlessly integrate any O₂ sensor device into data collection
- Can utilize the motorcycle's stock narrow band O₂ sensors (if equipped)
- View 3D plots in a grid or in color and view statistics on collected data
- View and adjust tables simply
- Easy to apply manual corrections of VE and spark tables
- Can apply changes to front and rear tables simultaneously
- Keys are available with either 5 or 10 licenses; one license used per motorcycle
- Made in the U.S.A.

NOTE: PART #1020-2409 includes VCM-TR3 communication hardware and cables. License keys need to be purchased separately.
NOTE: If you have a Centurion Super Pro or Centurion Super Pro Plus, PART #1020-2409 is NOT needed.

DESCRIPTION	PART #	SUG. RETAIL	DESCRIPTION	PART #	SUG. RETAIL
Tune Builder VCM (does not include keys)	1020-2409	\$713.95	Tune Builder License key w/ ten licenses	1020-2414	\$85.95 (ea.)
Tune Builder License Key w/ five licenses	1020-2413	85.95 (ea.)			

DISCLAIMER: NOT LEGAL FOR SALE OR USE IN CALIFORNIA ON ANY POLLUTION CONTROLLED MOTOR VEHICLES. SEE PAGE 3 FOR IMPORTANT EMISSION DEFINITIONS AND REGULATORY COMPLIANCE AND WARRANTY INFORMATION.

All part numbers in **BOLD MAGENTA** are new this year.

partsnetweb.com / dragnetweb.com

VICTORY

EXHAUST

LUGGAGE

SECURITY

WINDSHIELDS

FAIRINGS & BODY

SEATS & SISSEY BARS

HANDLEBARS & HAND CONTROLS

FOOTPEGS & FOOT CONTROLS

LIGHTING

ELECTRICAL

WHEELS & ACCESSORIES

BRAKES & SUSPENSION

ENGINE

FUEL/AIR SYSTEMS

INDIAN

EXHAUST

WINDSHIELDS

FAIRINGS & BODY

SEATS & SISSEY BARS

HANDLEBARS & HAND CONTROLS

FOOTPEGS & FOOT CONTROLS

LIGHTING

ELECTRICAL

WHEELS & BRAKES

SUSPENSION

ENGINE

FUEL/AIR SYSTEMS

VICTORY

EXHAUST

LUGGAGE

SECURITY

WINDSHIELDS

FAIRINGS & BODY

SEATS & SISSY BARS

HANDLEBARS & HAND CONTROLS

FOOTPEGS & FOOT CONTROLS

LIGHTING

ELECTRICAL

WHEELS & ACCESSORIES

BRAKES & SUSPENSION

ENGINE

FUEL/AIR SYSTEMS

INDIAN

EXHAUST

WINDSHIELDS

FAIRINGS & BODY

SEATS & SISSY BARS

HANDLEBARS & HAND CONTROLS

FOOTPEGS & FOOT CONTROLS

LIGHTING

ELECTRICAL

WHEELS & BRAKES

SUSPENSION

ENGINE

FUEL/AIR SYSTEMS

122

TECHNORESEARCH

TRO₂ WIDEBAND AIR/FUEL RATIO SYSTEM

- Essential tuning assistant designed to be used with data logging systems such as a dyno or the Mobile Dyno feature from TechnoResearch found in Centurion Pro, Centurion Pro Plus and Tune Builder
- Includes two Bosch LSU 4.2 O₂ sensors with 7 foot long cables for easy and versatile usage
- Interfaces directly with any TechnoResearch VCM-TR3 communication module found with products such as Tune Builder, Centurion Pro, Centurion Pro Plus
- No calibration required with digital precision
- 12 volt DC power input required
- Made in the U.S.A.



SUG. RETAIL \$569.95 PART # 3807-0343

Dynojet

POWER COMMANDER V

- Fuel control for each individual cylinder in a smaller enclosure
- "Warm-up" fuel adjustment (unit reads engine temp and allows fuel/timing adjustments based on the reading)
- Includes ignition adjustment feature; allows full ignition timing control of each cylinder
- Easy to install
- USB powered from computer; 9 volt adapter is no longer needed
- Two-position map-switching function built in
- Can add any Single Pole Single Throw (SPST) switch and toggle between two different fuel maps
- Gear/speed input allows for map adjustment based on gear
- Analog input allows user to install any 0-5 volt sensor
- Build an adjustment table based on analog input such as boost or temperature
- Power Commander V is capable of allowing each cylinder to be mapped individually and for each gear with the gear position input connected
- Enhanced "accel pump" utility
- Made in the U.S.A.



SUG. RETAIL \$419.95

FITS MODEL	PART #	FITS MODEL	PART #	FITS MODEL	PART #
INDIAN		INDIAN (CONT)		INDIAN (CONT)	
Scout 15-16	1020-2392	Chief 14-16	1020-2130 ¹	Scout Sixty 17	1020-2628

¹ Includes ignition adjustment.

Dynojet

POD-300 DIGITAL DISPLAY

- Real time fuel adjustment
- Display channels real-time: RPM, TP, map position (when using map switch), duty cycle, fuel exchange, ignition change and wideband air/fuel ratio (w/ WB2 or auto-tune connected)
- Weather resistant for use in all conditions
- Log channels saved to internal memory and can be viewed/analyzed with Dynojet's powercore software
- High contrast display, viewable in sunlight
- Includes CAN cable for attachment to Power Commander V, Auto Tune and Wide Band Power Commander



NOTE: Not for use with Power Commander III USB.
SUG. RETAIL \$249.95 PART # 1020-2371

Dynojet

POWER COMMANDER V MAP SELECT SWITCH

- Switches between two different maps that have been pre-loaded in a Power Commander V
- Comes with a switch, wiring and instructions
- Universal mount



SUG. RETAIL \$49.95 PART # 1020-2082

DISCLAIMER: NOT LEGAL FOR SALE OR USE IN CALIFORNIA ON ANY POLLUTION CONTROLLED MOTOR VEHICLES. SEE PAGE 3 FOR IMPORTANT EMISSION DEFINITIONS AND REGULATORY COMPLIANCE AND WARRANTY INFORMATION.



VICTORY

EXHAUST

LUGGAGE

SECURITY

WINDSHIELDS

FAIRINGS & BODY

SEATS & SISSEY BARS

HANDLEBARS & HAND CONTROLS

FOOTPEGS & FOOT CONTROLS

LIGHTING

ELECTRICAL

WHEELS & ACCESSORIES

BRAKES & SUSPENSION

ENGINE

FUEL/AIR SYSTEMS

INDIAN

EXHAUST

WINDSHIELDS

FAIRINGS & BODY

SEATS & SISSEY BARS

HANDLEBARS & HAND CONTROLS

FOOTPEGS & FOOT CONTROLS

LIGHTING

ELECTRICAL

WHEELS & BRAKES

SUSPENSION

ENGINE

FUEL/AIR SYSTEMS

123

AIR CLEANER KITS WITH COVERS

FOR INDIAN CHIEF CLASSIC, CHIEF VINTAGE, CHIEFTAIN AND ROADMASTER MODELS 14-16



- Engineered to boost performance
- High-flow air filter provides twice the surface area of the stock filter for up to 37% more airflow and a five horsepower gain
- Design maintains leg clearance
- Billet aluminum construction with a high-quality, washable and re-usable cotton gauze air filter element
- Covers are made from billet aluminum and show-chrome plated
- Optional S&S® Pre-filter available separately
- Made in the U.S.A.

SUG. RETAIL **\$425.95**

DESCRIPTION	PART #	DESCRIPTION	PART #
W/ Nostalgic Script cover	1010-2007	W/ S&S Logo cover	1010-2008

AIR CLEANER KITS AND COVERS

FOR INDIAN CHIEF CLASSIC, CHIEF VINTAGE, CHIEFTAIN AND ROADMASTER MODELS 14-16



- Engineered to boost performance
- High-flow air filter provides twice the surface area of the stock filter for up to 37% more airflow and a five horsepower gain
- Design maintains leg clearance
- Billet aluminum construction with a high-quality, washable and re-usable cotton gauze air filter element
- Covers not included, optional air cleaner covers sold separately; must order an air cleaner kit and cover for a complete assembly
- Covers are made from billet aluminum and show-chrome plated
- Optional S&S® Pre-filter available separately
- Made in the U.S.A.

NOTE: PART #1010-1612 CA Exempt per C.A.R.B. E.O. D-355-15 for 14-15 model years.

DESCRIPTION	PART #	SUG. RETAIL	DESCRIPTION	PART #	SUG. RETAIL
Air cleaner kit	1010-2006	\$299.95	OPTIONAL CHROME COVERS		
Air cleaner kit, original	1010-1612	299.95	S&S® Nostalgic Script air cleaner cover	1014-0219	\$129.95
			S&S® logo air cleaner cover	1014-0220	129.95



STEALTH TWO AIR CLEANER KIT

FOR INDIAN SCOUT/ SCOUT 60 14-16



- One-piece, black molded filter body with blue element
- Element constructed of pleated cotton
- Optional high-flow (1" taller) filter and pre-filter/rain sock also available
- Made in the U.S.A.

NOTE: Exempt per CARB EXECUTIVE ORDER (E.O) No. D-355-16.

SUG. RETAIL **\$149.95** PART # **1010-2009**

PRE-FILTER FOR INDIAN CHIEF/ CHIEFTAIN 14-16



- Water resistant and traps large dirt particles

SUG. RETAIL **\$24.95** PART # **1011-3491**

DISCLAIMER: NOT LEGAL FOR SALE OR USE IN CALIFORNIA ON ANY POLLUTION CONTROLLED MOTOR VEHICLES. SEE PAGE 3 FOR IMPORTANT EMISSION DEFINITIONS AND REGULATORY COMPLIANCE AND WARRANTY INFORMATION.

All part numbers in **BOLD MAGENTA** are new this year.

VICTORY

EXHAUST

LUGGAGE

SECURITY

WINDSHIELDS

FAIRINGS & BODY

SEATS & Sissy BARS

HANDLEBARS & HAND CONTROLS

FOOTPEGS & FOOT CONTROLS

LIGHTING

ELECTRICAL

WHEELS & ACCESSORIES

BRAKES & SUSPENSION

ENGINE

FUEL/AIR SYSTEMS

INDIAN

EXHAUST

WINDSHIELDS

FAIRINGS & BODY

SEATS & Sissy BARS

HANDLEBARS & HAND CONTROLS

FOOTPEGS & FOOT CONTROLS

LIGHTING

ELECTRICAL

WHEELS & BRAKES

SUSPENSION

ENGINE

FUEL/AIR SYSTEMS



MAX HP AIR CLEANER FOR INDIAN CHIEFTAIN 14-16

- CNC-machined aluminum backing plate
- Internal rubber breather tubes to eliminate oil leakage
- Internal power cone design for smooth, laminar air flow
- Innovative conical design for improved knee clearance
- Contrast Cut™ finish starts with a polished air cleaner that has been black anodized, then recut to open the design
- All mounting hardware and gaskets included
- Made in the U.S.A.

1010-1977



1010-1978



SUG. RETAIL \$449.95

DESCRIPTION	PART #	DESCRIPTION	PART #
Contrast Cut™	1010-1977	Chrome	1010-1978



POWERFLOW AIR CLEANER FOR INDIAN SCOUT 14-16

- Improves airflow and efficiency of engine
- Increases horsepower and torque with no additional remapping
- High-quality rubber construction, six layers of cotton gauze and epoxy-coated wire mesh makes the POWERFLOW durable, washable and reusable
- Made in the U.S.A.



SUG. RETAIL \$149.95

PART # 1010-1967



HIGH-FLOW OEM REPLACEMENT AIR FILTERS

- Designed to increase horsepower and torque
- Pleated design provides increased air-flow and high filtration
- Original K&N High-Flow Technology
- Application specific sealing bead ensures an air-tight fit
- Epoxy-coated aluminum backfire screen protects filter element
- Made in the U.S.A. for over 45 years



1011-3818



1011-3730



1011-1278

FITS MODEL	PART #	SUG. RETAIL
INDIAN		
Chief 02-03	1011-2850	\$53.95
Chief 09-13	1011-3837	58.95
Chief 14-16	1011-3818	89.95
Scout 15-16	1011-3730	76.95

FITS MODEL	PART #	SUG. RETAIL
INDIAN (CONT)		
Indian repl. filter 6" OD x 4 ⁵ / ₈ " ID x 2 ³ / ₄ " H fits stock S&S teardrop back and Indian teardrop cover (Indian cover not included)	1011-1278	\$77.95



OEM-STYLE REPLACEMENT AIR FILTER ELEMENTS

- High-quality paper filter medium
- Meets or exceeds OEM specifications
- For use with OEM stock air filter housings



1011-3522



1011-3523



APPLICATIONS

FITS MODEL	PART #	FITS MODEL	PART #
Chief Classic/Vintage/Chieftain 14-16	1011-3523	Chieftain/Roadmaster 15-16	1011-3523
Chief Classic/Vintage 15-16	1011-3523	Scout 15-16	1011-3522

PRICE LIST

PART #	REPLACES OEM #	SUG. RETAIL	PART #	REPLACES OEM #	SUG. RETAIL
1011-3522	7082024	\$17.95	1011-3523	5813976	\$36.95

DISCLAIMER: NOT LEGAL FOR SALE OR USE IN CALIFORNIA ON ANY POLLUTION CONTROLLED MOTOR VEHICLES. SEE PAGE 3 FOR IMPORTANT EMISSION DEFINITIONS AND REGULATORY COMPLIANCE AND WARRANTY INFORMATION.

VICTORY CROSS-REFERENCE

FITS MODEL	TIRES		CHAIN	SPROCKETS		BATTERY	NGK PLUG TYPE
	FRONT	REAR		FRONT	REAR		
VICTORY							
V92C Victory 98-02	MT90/16	160/80-16	Belt	N/A	N/A	YTX16-BS	DPR8EA9
V92SC 00-02	120/70-17	180/55-17	Belt	N/A	N/A	YTX16-BS	DPR8EA9
V92TC 02-06	120/70-17	180/55-17	Belt	N/A	N/A	YTX16-BS	DPR8EA9
Boardwalk 10-14	130/90-16	150/80-16	Belt	N/A	N/A	YTX20HL-BS	-
Cross Country 10-15	130/70-18	180/60-16	Belt	N/A	N/A	YTX20HL-BS	-
Cross Country Tour 12-15	130/70-18	180/60-16	Belt	N/A	N/A	YTX20HL-BS	-
Crossroads 10-15	130/70-18	180/60-16	Belt	N/A	N/A	YTX20HL-BS	-
Gunner 15-16	130/90-16	140/90-16	Belt	N/A	N/A	YTX20HL-BS	-
Hammer/S/8-Ball 05-15	130/70-18	250/40-18	Belt	N/A	N/A	YTX16-BS	-
HighBall 12-15	130/90-16	150/80-16	Belt	N/A	N/A	YTX20HL-BS	-
Judge 12-14	130/90-16	140/90-16	Belt	N/A	N/A	YTX20HL-BS	-
Magnum/Magnum X-1 15-16	120/70-21	180/60-16	Belt	N/A	N/A	-	-
Octane 16	130/70-18	160/70-17	Belt	N/A	N/A	-	-
Vegas 03-09	90/90-21	180/55-18	Belt	N/A	N/A	YTX20HL-BS	-
Vegas 8-Ball 10-15	90/90-21	180/55-18	Belt	N/A	N/A	YTX20HL-BS	-
Vegas Jackpot	90/90-21	250/40-18	Belt	N/A	N/A	YTX20HL-BS	-
Victory Vision 08-16	130/70-18	180/60-16	Belt	N/A	N/A	YTX20HL-BS	-

INDIAN CROSS-REFERENCE

MODEL	TIRES		FINAL DRIVE	SPROCKETS		BATTERY	NGK PLUG TYPE
	FRONT	REAR		FRONT	REAR		
INDIAN							
Chief Classic/Vintage 14-17	130/90B16	180/65B16	Belt	N/A	N/A	YTX20HL	N/A
Chief Dark Horse 16-17	130/90B16	180/65B16	Belt	N/A	N/A	YTX20HL	N/A
Chieftain 15-17	130/90B16	180/60R16	Belt	N/A	N/A	YTX20HL	N/A
Roadmaster 15-17	130/90B16	180/60R16	Belt	N/A	N/A	YTX20HL	N/A
Scout 15-17	130/90-16	150/80-16	Belt	N/A	N/A	N/A	N/A
Scout 60 16-17	130/90-16	150/80-16	Belt	N/A	N/A	N/A	N/A

A

Accutronix	
Forward control extension kit	50
Forward controls	50
Side-mount license plate brackets	30
Air cleaner kit	81
Air filters	81
Air intake assemblies emission control regulatory information	3
Airmaster® windshields	24
Alarm wiring kits	18
Alarms	17-18
All Balls	
Steering stem bearings	46
Wheel bearing/seal kits	65
Armrests	42

B

Backrest mount kit	42
Backrests	35-37, 40-42
Badlands	
Illuminator modules	59
Baggershield™ windshield	24
Bahn	
Clutch cover accent	31
Crankcase cover accents	31
Footpegs	54
Fork lowers accents	31
Ignition covers	31
Mirrors	46
Valve cover accents	31
Ballistic	
Battery application chart	60
Lithium Ion batteries	60
Bar-end mirror	46
Barnett	
Clutch plates	74
Clutch spring and pressure plate	74
Control cables	48
Scorpion billet clutches	74
Bassani	
End caps	7
Exhaust	6-11
Mufflers	10-11
Batteries	60-61
Battery application chart	61
Batwing fairing	25
Batwing fairing mount kits	25
Batwing fairing trim/accents	26
Batwing fairing wind deflectors	26
Batwing fairing windshield pouches	26
Batwing fairing windshields	24, 26-27
Bearings, steering stem	46
Bearings, wheel	65
Beverage holder	49
Brake lines, stainless steel	72
Brake pad application chart	66
Brake pads	66-70
Brake pedal pad covers	53-54
Brake rotors	71
Brake/run/turn light modules	59
Brake/shift pegs	53-54

BRAKES & SUSPENSION 66-72

Braking	
Brake pads	70
Build-your-own saddlebag kit	13

C

Cables, control	47-48
Cam's emission control regulatory information	3
CARB E.O. (Executive Order)	3
Carburetors and part kits emission control regulatory information	3
Carl Brouhard Designs	
Shift pegs	54
Centurion Pro upgrade kit	79
Centurion Super Pro diagnostic tool system	78
Cheese Wedge emblems	57
Clutch arm cover	33
Clutch cables	47-48
Clutch cover accent	31
Clutch kits/discs/springs	74
Cobra	
F12000 Powrpro Black	80
Contour handlebar control kits	44
Contour handlebar control spacers	44
Contour handlebar switches	44
Control cables	47-48
Crankcase cover accents	31
Cruise assists, mechanical	45
Cruise pegs, passenger	52
Cup holder	49
Custom Dynamics	
Cheese Wedge badges	57
Fork tube turn signal clamps	57
Laydown license plate bracket	29
Load equalizer	59
Rear LED turn signals	57
Side-mount license plate brackets	29
Turn signals w/ running lights	57
Wrap-around marker lights	57
D	
Dash accent	32
Dipstick	74
Display for Power Commanders	77
DP Brakes	
Brake pads	67
Drag Specialties	
Air filters	81
Batteries	61
Brake pads	66
Oil filter	75
Spark plug wires	62
T-Bar handlebars	43
Drag Specialties Seats	
Backrests	35-37, 40
Seats	34-40
Drive belt pulleys	65
Driving lights/kits	58-59
Dynojet	
Map selector switch for Power Commander	77

Dynojet (CONT)

POD-300 display	77
Power Commanders	77

E

EBC

Brake pads	68
Brake rotors	71
Electric shift kits	56

ELECTRICAL 60-63

Electrical emission control regulatory information	3
Electronics holders/mounts	49
Emissions Information	3
End caps, exhaust	7, 10
ENGINE 73-76	
Engine covers/accents	31
Engine cylinder base accents	73
Engine emission control regulatory information	3
Engine gaskets/seals/O-rings	76
Engine guard Toe Rest cruise pegs	52
Engine V side covers	73
Engine/fuel diagnostic tool system	78

EXHAUST 6-12

Exhaust emission control regulatory information	3
Exhaust products emission control regulatory information	3
Exhaust system end caps	7, 10
Exhaust systems	6-9, 11

F

Fairing eyebrows	27
Fairing, Batwing	25
FAIRINGS & BODY 25-33	
Filters, air	81
Filters, oil	75-76
Five-to-four trailer wire converter module	63
Flexible marker lights	57

Flo

Re-useable oil filter	75
Floorboard inserts	51
Floorboards	51
Footpeg adapters	54
Footpegs	52-54

FOOTPEGS & FOOT CONTROLS 50-56

Fork leg covers	32
Fork lowers accents	31
Fork tube turn signal clamps	57
Forward control extension kit	50
Forward controls	50

Fram

Oil filter	76
Front fenders/fender kits	28-29
Front kick accents, saddlebag	16
Fuel controllers/modules emission control regulatory information	3
Fuel flow programmers emission control regulatory information	3
Fuel flow tuners emission control regulatory information	3

Fuel injection modules	77-80
FUEL/AIR SYSTEMS	77-81
Fuel/air systems emission control regulatory information	3
Fuel/engine diagnostic tool system	78

G

Gas tank bras	30
Gas tank trim	33
Gaskets/seals/O-rings, engine	76

Genuine James

Gaskets/seals/O-rings	76
GPS/smartphone/iPhone® mounts	49
Grips	45

H

Handlebar beverage/cup holder	49
Handlebar control conversion kits	44
Handlebar control kits	44
Handlebar grips	45
Handlebar switches	44
Handlebar wiring extension harness	63
Handlebars	43

HANDLEBARS & HAND CONTROLS 43-49

Hard Bagger

Top Shelf® organizer	16
Hard saddlebags	13-14

Hardstreet

Pro Builder saddlebag kit	13
Saddlebags	13-14
Hardware/mount kits, Batwing fairing	25

Headlight protector	58
Heated seat	42
Hide-A-Key pouch	15

Hiflofiltro

Oil filter	76
Highway bar rain guards	56
Highway bars	55
Hinges, saddlebag	16

Hopnel

Gas tank mini bras	30
Hide-A-Key pouch	15
Pac-A-Derms™	56
Saddlebag lid bras	15
Saddlebag liner bags	15
Solo rack bag	15
Trunk liner bag	15
Tuxedo™ Tie w/ pouch	30
Windshield tri-pouch	15

I

Ignition covers	31
Ignition disabler, alarm	18
Illuminator modules, run/turn/brake	59
Inner primary cover	73
iOmounts™ device mounts	49
iPhone®/smartphone/GPS mounts	49
ISO®-Grips	45
ISO®-Pegs	52

K

K&N

Air filters	81
Oil filter	75

Klip Hanger handlebars	43
Klock Werks	
iOmounts™	49
Klip Hanger handlebars	43
Tire Hugger front fender kits	28

Kuryakyn

Airmaster® windshields	24
Backrest mount kit	42
Bar-end mirror	46
Brake pedal pad cover	53
Clutch arm cover	33
Dash accent	32
Driving lights	59
Engine cylinder base accents	73
Engine V side covers	73
Fairing eyebrows	27
Floorboard inserts	51
Floorboards	51
Footpeg adapters	54
Footpegs	52-53
Fork leg covers	32
Grips	45
Inner primary cover	73
Laydown license plate frame	30
LED saddlebag accents	59
LED saddlebag extensions	59
LED speaker grilles	32
Mechanical cruise assist	45
Passenger cruise pegs	52
Plug-And-Go backrest	42
Raised mirror adapters	46
Saddlebag front kick accents	16
Saddlebag hinges	16
Saddlebag side swoops	16
Saddlebag top accents	16
Shift/brake pegs	53
Spark plug fillers	33
Splined footpeg adapters	54
Splined passenger floorboard mount adapters	51
Switch panel cover	32
Taillight top trim	33
Tank speed lines	33
Tie-down brackets	33
Toe Rest cruise pegs	52
Transmission center cover	73
Windshield accents	24

L

Laydown license plate brackets	29-30
--------------------------------	-------

Leader

Highway bar rain guards	56
LED speaker grilles	32
LED turn signals, rear	57
License plate frame	30
License plate mount brackets	29-30
Lighted Cheese Wedge emblems	57
Lighted saddlebag extensions	59

LIGHTING 57-59

Linbar® highway bars	55
----------------------	----

Lindby

Linbar® highway bars	55
Lithium Ion batteries	60

Load equalizer	59
Lower, windshield	23
LUGGAGE	13-16
Luggage rack bag	15

Lyndall Brakes

Brake pads	70
------------	----

M

Magnum

Control cables	47
Stainless steel brake lines	72
Map selector switch for Power Commander	77
Marker lights	57
Maximus flash tuning tool	78

Memphis Shades

Batwing fairing	25
Batwing fairing trim/accessories	26
Batwing fairing wind deflectors	26
Batwing fairing windshields	26
Booster Wing	27
Hot Wing	27
Side Wings	27

Spoiler windshield for Batwing fairing	27
----------------------------------------	----

Trigger-Lock Batwing fairing mount kits	25
-----------------------------------------	----

Trigger-Lock windshield mount kits	21
------------------------------------	----

Windshield lowers	23
Windshield lowers mount kits	21

Windshield pouches	26
Windshields	19-23

Mirror adapters	46
Mirrors	46

Motorcycle alarms	17-18
Motorcycle seats	34-42

Mounts, iPhone®/smartphone/GPS mounts	49
---------------------------------------	----

Mufflers	10-12
Multibar®	55

Mustang

Backrest	41
Heated seat	42
Seats	41-42

N

Namz

5-to-4 trailer isolation wiring module	63
----------------------------------------	----

Handlebar control wiring conversion kits	44
------------------------------------------	----

Handlebar wiring extension harness	63
Rear LED turn signals	59

O

O ₂ eliminators emission control regulatory information	3
--------------------------------------------------------------------	---

Oil dipstick	74
--------------	----

Oil filter application chart	76
------------------------------	----

Oil filters	75-76
-------------	-------

Oxygen sensors emission control regulatory information	3
--------------------------------------------------------	---

P	
Pac-A-Derms™	56
Parts Unlimited	
Batteries	61
Oil filter	75
Starters	63
Passenger cruise pegs	52
Performance Machine	
Handlebar control kits	44
Handlebar control spacers	44
Handlebar switches	44
Throttle cable housings	44
Perimeter sensor, alarm	18
Pingel	
Electric shift kits	56
Oil dipstick	74
Pivot Works	
Wheel bearing/seal kits	65
POD-300 display	77
Pouch, Hide-A-Key	15
Power Commander map selector switch	77
Power Commanders POD-300 display	77
Power Commanders	77
Power Max	
Batteries	60
Progressive Suspension	
Shock absorbers	72
Pulleys, rear wheel	65
Q	
Qualified Manufacturer Declared Replacement part	3
R	
Rack bag	15
Rain guards, highway bar	56
Raised mirror adapters	46
RC Components	
Brake rotors	71
Front fender kits	29
Pulleys	65
Wheels	64
Rear LED turn signals	57, 59
Rectifiers/regulators	62
Regulators/rectifiers	62
Re-usable oil filter	75
Rick's Motorsport	
Rectifiers/regulators	62
Rivco	
Armrests	42
Trailer hitch	30
Rocker switch	63
Run/turn/brake light modules	59
S	
S&S	
Stealth air cleaner kit	81

Saddlebag accents/trim	16
Saddlebag extensions, lighted	59
Saddlebag kit	13
Saddlebag lid bras	15
Saddlebag liner bags	15
Saddlebag tray/organizer	16
Saddlebags	13-14
SBS	
Brake pads	69
Scorpio	
Alarm accessories	18
Alarm wiring kits	18
Alarms/security systems	17-18
Scorpion billet clutch assemblies	74
SEATS & SISSY BARS	34-42
SECURITY	17-18
Security systems, motorcycle	17-18
Shift/brake pegs	53-54
Shock absorbers	72
Show Chrome	
Brake pedal pad kit	54
Driving lights/kits	58
Gadget bar/mount	49
Handlebar beverage holder	49
Handlebar phone holder	49
Headlight protector	58
Rocker switch	63
Side Wings for windshields	27
Side-mount license plate mount brackets	29-30
Slip Streamer	
Baggershield™	24
Slip-on mufflers	10-12
Smartphone/iPhone®/GPS mounts	49
Spark plug filler accents	33
Spark plug wires	62
Speaker grilles w/ LEDs	32
Splined footpeg adapters	54
Splined passenger floorboard mount adapters	51
Stainless steel brake lines	72
Starters	63
Steering stem bearings	46
SUSPENSION	72
Sweptwing footpegs	52
Swingwing footpegs	53
Switch panel cover	32
Switchblade footpegs, Flamin'	53
T	
Taillight top trim	33
Tank speed lines	33
T-Bar handlebars	43
Techno Research	
Centurion Pro Victory upgrade kit	79
Centurion Super Pro	78
Maximum Victory tuner	78

Techno Research (CONT)	
TRO ₂ wide band air/fuel ratio system	79
Tune Builder	79
Throttle cable housings	44
Throttle cables	47-48
Tie-down brackets	33
Tire Hugger front fender kits	28
Toe Rest cruise pegs	52
Trailer hitch	30
Trailer wiring isolator module	63
Transmission center cover	73
Trask	
Exhaust	11
Trigger-Lock mount kits, Batwing fairing	25
Trigger-Lock windshield mount kits	21
Trim/accents, saddlebag	16
TRO ₂ wide band air/fuel ratio monitor	79
Trunk liner bag	15
Turn signals	57, 59
Turn/run/brake light modules	59
Tuxedo™ Tie w/ pouch	30

V	
Valve cover accents	31
Vance & Hines	
Mufflers	12
Victory Centurion Pro upgrade kit	79
Victory 106 emblems, lighted	57

W	
Wheel bearings/seals	65
Wheels	64
WHEELS & ACCESSORIES	64-65
Wide band air/fuel ratio monitor	79
Widow footpegs	53
Wind deflectors, Batwing fairing	26
Windshield lower mount kits	21
Windshield lowers	23
Windshield mount kits	21
Windshield pouches	15, 26
Windshield trim/accents	24, 26-27
WINDSHIELDS	19-24
Windshields for Batwing fairings	24, 26-27
Wire, spark plug	62
Wiring conversion kits, handlebar control	44
Wiring kits for alarms/security systems	18
Wiseco	
Fuel management controller	80
Wrap-around marker lights	57

Y	
Yuasa	
Batteries	60
Z	
Zombie™ footpegs	53

Victory® is a registered trademark of Polaris Industries, Inc.

Victory model designations are utilized in this catalog for reference only: Boardwalk®, Cross Country®, Crossroads™, Victory Gunner®, Hammer®, Hammer S™, Hammer 8-Ball®, HighBall™, Victory Judge®, Magnum®, Victory Octane®, Vegas™, Vegas Jackpot®, Vegas 8-Ball®, Victory Vision®, V92C™, V92SC™, and V92TC™.

A	
Accutronix	
Floorboards	105
Footpeg adapters	105
Side-mount license plates	91
Air cleaner kits and covers	123
Air cleaners	123-124
Air filters	124
Air intake assemblies emission control regulatory information	3
Arlen Ness	
Fairings	91
Shock absorber	118
Avon	
Grips	101
B	
Backrests, passenger	97
Badlands	
Illuminator module	110
Ballistic	
Batteries	111
Barnett	
Cables	102
Clutch kit	120
Bassani	
Exhaust end caps	84
Exhaust systems	84
Mufflers	84-85
Batteries	111-113
Battery application chart	113
Bezels	109
Brake arms	104
Brake lines	117
Brake pad application chart	115
Brake pads	115-117
Brake pedal covers	104
Brake pedals	104
Brake/shift pegs	107
C	
Cables	102
Cam's emission control regulatory information	3
CARB E.O. (Executive Order)	3
Carburetors and part kits emission control regulatory information	3
Carl Brouhard Designs	
Brake arms	104
Brake pedal covers	104
Brake pedals	104
Floorboards	104
Grips	101
Shifter pegs	105
Shifters	105
Clutch cables	102
Clutch kit	120
Cobra	
Mufflers	88
Crusher	
Exhaust	88
Curved license plate frame, LED	91
Custom Dynamics	
Lighting clamps	109
Marker lights	109
Turn signals	109

D	
Device mounts	102
Diagnostic tool system	121
Diagnostic tool system upgrade kit	121
Double flag/license plate holder	94
DP Brakes	
Brake pads	115-116
Drag Specialties	
Air filters	124
Batteries	112
Brake pads	115
Ignition coils	113
Oil filters	119
Spark plug wires	114
Wheel assemblies	114
Drink holder, passenger	95
Driver floorboard inserts	107
Driver floorboards	104-105, 108
Driving light bezels	109
Driving lights	110
Dynojet	
LCD display for Power Commander	122
Map select switch for Power Commander	122
Power Commander V	122
E	
EBC	
Brake pads	115, 117
Electric easy shift speed shifter kit	108
Electrical emission control regulatory information	3
ELECTRICAL	111-114
Emissions Information	3
End caps, exhaust	84
ENGINE	119-120
Engine emission control regulatory information	3
EXHAUST	83-88
Exhaust baffles	86-87
Exhaust emission control regulatory information	3
Exhaust end caps	84
Exhaust products emission control regulatory information	3
Exhaust systems	83-84, 86
F	
Fairing turn signal trim	93
FAIRINGS & BODY	91-95
Fairings	91
Fender bibs	91
Fender strip lights	109
Fi2000	
Fuel injection controller	120
Filters, air	124
Flag mounts w/ flag	94
Flare™ windshields	90
Flo	
Oil filter	119
Floorboard inserts, driver	107
Floorboard mount adapter, passenger	107
Floorboard mounting kit	108
Floorboards	103-105, 108
Footpeg adapters	105, 107

Footpegs	106, 108
FOOTPEGS & FOOT CONTROLS	103-108
Fork lowering kits	118
Fork springs	118
Fork tube covers	118
Front brake lines	117
Front fenders	92
Front wheels	114
Fuel controllers/modules emission control regulatory information	3
Fuel flow programmers emission control regulatory information	3
Fuel flow tuners emission control regulatory information	3
Fuel injection controllers/modules	120, 122
Fuel ratio system	122
FUEL/AIR SYSTEMS	120-124
Fuel/air systems emission control regulatory information	3
G	
Grips	100-101
H	
Handlebar kits	99
Handlebars	99-100
HANDLEBARS & HAND CONTROLS	99-102
Hidden trailer hitch	94
Hide A Key pouch	95
Hiflofiltro	
Oil filters	119
Highway bar rain guards	103
Highway bars	103
Hopnel	
Hide A Key pouch	95
Solo rack bag	95
I	
Ignition coils	113
Illuminator module	110
Inner primary cover	120
iOmounts device mounts	102
ISO®-Grips	100
ISO®-Pegs	106
K	
K&N	
Air filters	124
Khrome Werks	
Mufflers	88
Klock Werks	
Flare™ windshields	90
Floorboard mounting kit	108
Front fenders	92
Handlebar kits	99
Handlebars	99
iOmounts device mounts	102
Number plate kit	92
Radiator guard	92
Rear fender	92
Seat pan kits	98
Kuryakyn	
Fairing turn signal trim	93
Fender strip lights	109
Floorboard inserts, driver	107

Kuryakyn (CONT)

Floorboard mount	
adapter, passenger	107
Footpeg adapters	107
Footpegs	106
Grips	100
LED curved license plate frame	91
Light bezels	109
Mirror adapters	101
Oil cooler cover	93
Passenger drink holder	95
Primary cover	120
Saddle shields	98
Saddlebag top trim	95
Shift/brake pegs	107
Speaker grilles	93
Starter cover	94
Taillight top trim	94
Tappet block accents	120
Top dash accent	93
Trunk light accent	109
Windshield trim	93

L

Laced wheels	114
LCD display for Power Commander	122

Leader

Highway bar rain guards	103
LED curved license plate frame	91
LED marker lights	109
LED turn signals	110
License plate frames	91
License plate/double flag holder	94
Light bezels	109

LIGHTING 109-110

Lighting clamps	109
Linbar® highway bars	103

Lindby

Linbar® highway bars	103
Lithium-ion batteries	111

M

Magnum

Clutch cables	102
E-Z Align brake lines	117
Map select switch for	
Power Commander	122
Marker lights	109
Max HP air cleaner	124

Memphis Shades

Quick-Change windshield mount kits	90
Turn signal relocation kit	90
Windshield plate-only hardware kits	90
Windshields/mount kits	89-90

Mirror adapters	101
Mufflers	83-88

Mustang

Backrests, passenger	97
Fender bibs	91
Seats	96-97
Sissy bar pads	98

N

NAMZ

Turn signals	110
Number plate kit	92

O

O ₂ eliminators emission control	
regulatory information	3
Oil cooler cover	93
Oil filter application chart	119
Oil filters	119
Oxygen sensors emission control	
regulatory information	3

P

Parts Unlimited

Batteries	112
Passenger drink holder	95
Passenger floorboard mount adapter	107
Passenger floorboards	103-104

Performance Machine

Air cleaner	124
-------------	-----

Pingel

Electric easy shift speed shifter kit	108
---------------------------------------	-----

POD-300 LCD display for Power

Commander	122
Pouch, Hide A Key	95
Power Commander LCD display	122
Power Commander map select switch	122
Power Commander V	122

Power Max

Batteries	113
PowrPro fuel injection controller	120
Pre-filter	123
Primary cover, inner	120

Pro Pad

Flag mounts w/ flag	94
---------------------	----

Progressive Suspension

Fork lowering kits	118
Fork springs	118
Shocks	118

Q

Qualified Manufacturer Declared	
Replacement part	3
Quick-Change windshield mount kits	90

R

Rack bag, solo	95
Radiator guard	92
Rear fender	92
Rear fender strip lights	109
Rear wheels	114
Rectifier/regulator	113
Rick's Motorsport	
Rectifier/regulator	113
Rivco	
Floorboards	103
Hidden trailer hitch	94
License plate/double flag holder	94

Roland Sands Design

Seats	97
Run/turn/brake light module	110

S

S&S

Air cleaner kits and covers	123
Pre-filter	123
Saddle shields	98

Saddlebag top trim	95
--------------------	----

SBS

Brake pads	115-116
Seat pan kits	98
SEATS & SISSY BARS	96-98
Seats	96-97
Shift pegs	105, 107-108
Shift/brake pegs	107
Shifters	105
Shock absorber	118
Shocks	118

Show Chrome

Driving lights	110
Side-mount license plates	91
Sissy bar pads	98
Solo rack bag	95
Spark plug wires	114
Speaker grilles	93
Speed shifter kit, electric	108
Spin-on oil filter	119
Starter cover	94

SUSPENSION 118

T

Taillight top trim	94
Tappet block accents	120

Techno Research

Diagnostic tool system	121
Diagnostic tool system upgrade kit	121
Fuel ratio system	122
Tune builder	121
Toe-rest cruise pegs	106
Top dash accent	93
Trailer hitch, hidden	94

Trask

Air cleaner	124
Exhaust systems	83
Floorboards	108
Footpegs	108
Fork tube covers	118
Grips	100
Handlebars	100
Mufflers	83
Shift pegs	108
Trunk light accent	109
Tube lighting clamps	109
Tune builder	121
Turn signal relocation kit	90
Turn signals	109-110

V

Vance & Hines

Exhaust baffles	86-87
Exhaust systems	86
Mufflers	86-87

W

Wheel assemblies	114
WHEELS & BRAKES	114-117
Windshield plate-only hardware kits	90
Windshield trim	93
WINDSHIELDS	89-90

Y

Yuasa

Batteries	111
-----------	-----

Indian® is a registered trademark of Indian Motorcycle International, LLC.

Indian model designations are utilized in this catalog for reference only: Chief®, Chief Classic™, Chief Dark Horse®, Chief Vintage, Chieftain®, Roadmaster® and Scout®.



WE SUPPORT THE SPORT!®

We are the #1 resource for powersports products. We support our dealers, vendors and fans at races, rallies, special events and showcases across the country. You can find out more by checking out the nationally known brands listed below and featured in our catalogs.



www.parts-unlimited.com
inventory.partsnetweb.com



www.dragspecialties.com
inventory.dragnetweb.com



www.amstires.com



www.arctiva.com



www.mooseracing.com



www.rideicon.com



www.mooseutilities.com



www.slipperywetsuits.com



www.thormx.com



www.z1r.com

DEALER POLICIES

Please visit:

<http://www.partsnetweb.com/DealerPolicy>

and

<http://www.dragnetweb.com/DealerPolicy>

WARRANTIES AND GUARANTEES

We do not guarantee the items sold by us or warrant the merchantability or fitness of purpose. Manufacturers supply their own warranties and guarantees and most of them do not permit a wholesaler or distributor to make any adjustment, replace any part or accept for return or exchange any defective or unsatisfactory item. Please follow the guarantee instructions when provided by the manufacturer. Any damages arising from the design or manufacturing of any item are the sole responsibility of the manufacturer.

CATALOG CONTENTS

We believe the contents and specifications of this catalog are correct. We assume no liability for errors in listings, specifications, part numbers, prices or model applications. We reserve the right to change specifications, product descriptions, product quality, pricing and application at any time without further notice and without further obligation. The reproduction of any material from this catalog is forbidden without our written approval.

iPad®, iPhone®, iPhoto®, iPod®, iPod classic®, iPod nano®, iPod shuffle®, iPod touch®, MacBook®, MacBook Air® and PowerBook® are registered trademarks of Apple Inc.

Kevlar® brand fiber is a registered trademark of DuPont.

All model designations and applications used herein are determined by the manufacturer as USA-specific. Contact the individual manufacturer for additional international model information.



A DIVISION OF LEMANS CORPORATION

PO Box 5222, Janesville, WI 53547-5222, 608-758-1111

COPYRIGHT 2016
LeMans Corporation

ALL RIGHTS RESERVED
These materials may not
be copied or reproduced
in any manner without
written permission
of LeMans Corporation.



2017 PARTS & ACCESSORIES FOR VICTORY & INDIAN MOTORCYCLES

Printed in U.S.A.



9901-1965

DRAG Specialties PARTS UNLIMITED

Victory® is a registered trademark of Polaris Industries, Inc.
Indian® is a registered trademark of Indian Motorcycle International, LLC